



IGNITION
PARTS

MOTORCYCLE APPLICATIONS 2020/21

Jarek Pabijan



Emil Sayfutdinov

FIM Speedway World Championship



www.ngkntk.com

WE'VE GOT HER BACK

Maria Costello
Isle of Man TT

Gary Jones manxmanphotos.com

facebook.com/ngksparkplugsuk



[NGK UK YouTube](https://www.youtube.com/channel/UC...)



[instagram.com/ngkntk_uk](https://www.instagram.com/ngkntk_uk)



[NGK Spark Plugs \(UK\) Ltd](https://www.linkedin.com/company/ngk-spark-plugs-uk-ltd)



[ngkntk.com](https://www.ngkntk.com)



IGNITION
PARTS

SPARK PLUGS : GLOW PLUGS : COILS : LEADS : SENSORS FROM THE WORLD'S NO.1

CONTENTS

SPARK PLUG TECHNICAL INFORMATION

Spark Plug Design _____	2	Spark Plug Installation Tips _____	8
NGK's Copper Core Technology _____	3	Spark Plug Gap Settings _____	8
The Best Spark Plug for every occasion _____	4	Design Symbols _____	9
Fitting the Correct Spark Plug _____	5	New Additions and Part Numbers _____	10-11
The Iridium IX Spark Plug _____	6-7		

2 Wheel

Adly _____	12	Indian _____	38
AJS _____	12	Italjet _____	38
Aprilia _____	12-14	Jawa-CZ _____	38
Atala _____	14	Jialing _____	38-39
Bajaj _____	14	Jianshe _____	39
Baotian _____	14	Jinlun _____	39
Barossa _____	15	Jonway _____	39
Bashan _____	15	Kawasaki _____	39-43
Batavus _____	15	Keeway _____	43-44
Beeline _____	15	Kenos _____	44
Benelli _____	15-16	Kreidler _____	44
Benzhou _____	16	KSR Moto _____	44
Beta / Betamotor _____	16-17	KTM _____	44-47
Bimota _____	18	Kymco _____	47-48
BMW _____	18-19	Lambretta _____	48
BSA _____	20	Laverda _____	48
Buell _____	20	LEM _____	48
Cagiva _____	20-21	Lexmoto _____	48
Can-Am (BRP) _____	21	Lifan _____	49
CCM (Armstrong-CCM) _____	21-22	LML _____	49
CF Moto _____	22	Magni _____	49
Cossack _____	22	Maico _____	49
CPI _____	22	Malaguti _____	49
CZ (See Jawa-CZ) _____	-	MBK _____	50
Daelim _____	22-23	Montesa _____	50
Derbi _____	23	Moto Guzzi _____	50-51
Ducati _____	23-25	Moto Morini _____	51
EBR _____	26	Moto Roma _____	52
Fantic _____	26	Motobecane _____	52
Gas Gas _____	26-27	Motorhispania _____	52
Generic _____	27-28	MS _____	52
Gilera _____	28	MV Agusta _____	52-53
Harley Davidson _____	28-29	MZ _____	53
Herald Motor Company _____	29	Neval _____	53
Hero-Puch _____	29	Nipponia _____	53
Hesketh _____	29	Norton _____	53
Honda _____	29-35	Ossa _____	53
Huoniao _____	35	Peugeot _____	54-55
Husaberg _____	35	PGO _____	55
Husqvarna _____	35-37	Piaggio / Vespa _____	55-57
Hymoto _____	37	Pioneer _____	57
Hyosung _____	37-38	Puch _____	57

SPARK PLUG APPLICATIONS

Pulse _____	57	Adly _____	75
Regal Raptor _____	57	Apache _____	75
Regent _____	58	Arctic Cat _____	75
Riders _____	58	Ausa _____	75
Rieju _____	58	Blast (LEM) _____	75
Rovigo _____	58	Bombardier (-05) _____	75-76
Royal Enfield (1980-) _____	58	Can-Am (BRP) _____	76
RTX _____	58	Ceatek _____	76
Sachs _____	58-59	Club Car _____	76
Scorpa _____	59	CPI _____	76
Sherco _____	59	Cub Cadet _____	76
Simson _____	60	Cushman _____	77
Sinnis _____	60	Dinli _____	77
Skyteam _____	60	E-Ton _____	77
SMC _____	60	E-Z-Go _____	77
Superbyke _____	60	Gas Gas _____	77
Suzuki _____	60-64	Honda _____	77-78
SWM _____	64	Hymoto _____	78
SYM _____	64-65	Hyosung _____	78
Tamoretti _____	65	John Deere _____	78
TGB _____	65	Kawasaki _____	78-79
The Black Douglas Motorcycle Co. _____	65	Kazuma _____	79
TM Racing _____	66	KTM _____	79
Tomos _____	66	Kubota _____	79
Triumph Pre-1989 _____	66	Kymco _____	79
Triumph 1991-On _____	66-67	LEM _____	79
Uralmoto _____	68	Masai _____	79
Vertemati _____	68	Massey Ferguson _____	80
Vespa (See Piaggio) _____	-	Mota Roma _____	80
Victory (Polaris) _____	68	Polaris _____	80
Vixen (See Bashan) _____	-	Puzey _____	81
VOR _____	68	Quadzilla _____	81
White Knuckle (See WK) _____	-	Quantum _____	81
WK _____	68	Skyteam _____	81
Wuyang _____	68	Storm _____	81
Xispa _____	68	Suzuki _____	81-82
Yamaha _____	69-74	SYM _____	82
Yamasaki _____	74	TGB _____	82
Yiyi (See Benzhou) _____	-	Yamaha _____	82-83
Zing (See Lifan) _____	-	Conversion Chart _____	84-113
Znen _____	74		
Zongshen _____	74		

ATV Quad

SPARK PLUG COVERS

Cover Symbols Explanation Chart _____	115	Spark Plug Covers _____	116-118
NGK Resistor Plug Covers _____	115		

LAMBDA SENSORS

NTK Lambda Sensors for Motorcycles _____	119	Technical Information _____	119
Aprilia _____	120	Moto Guzzi _____	122
BMW _____	120	Moto Morini _____	122
Ducati _____	121	MV Agusta _____	122
Honda _____	121	Suzuki _____	122
Husqvarna _____	121	Triumph _____	123
Hyosung _____	121	Connector Types _____	124
KTM _____	121		
Kymco _____	121		

This catalogue is intended for vehicles/engines officially imported or manufactured in the UK and supersedes all previous versions, which should be disposed of. Whilst every care is taken in compiling these lists of applications, they are given for general guidance only, and do not constitute any contractual term, representation or warranty and as such NGK Spark Plugs (UK) Ltd. do not accept any responsibility in respect of any claim whatsoever and howsoever caused arising from the publication of this catalogue.

NGK and NTK products are designed solely for use in automotive, motorcycle, marine, horticultural, agricultural, commercial, industrial, and stationary engines.

NGK and NTK products should not be used in aircraft engines.

Resistor spark plugs should always be used where they are recommended by the manufacturer. The use of non-resistor plugs could, in some cases, result in interference with and/or damage to electronic components.

NGK and NTK products listed in the application guides do not apply to racing or modified engines, except where explicitly stated.

SPARK PLUG DESIGN

SPARK PLUG DESIGN

Every year the range of NGK spark plugs grows to accommodate the ever increasing demands of modern engines. Spark plug design must take into consideration many features of an engine including physical dimensions, combustion chamber shape, cooling abilities, fuel and ignition systems. Spark plugs play a vital role in producing the maximum power from an engine whilst keeping fuel consumption and emissions to a minimum. Choosing the correct spark plug type will help a vehicle manufacturer meet legislated emission targets and assists the motorist in getting the best from their engine.

Increases in the size and the requirement to improve the cooling of the inlet and exhaust valves have meant that the space available for the spark plug is severely restricted on some cylinder heads. A change in spark plug design, possibly the adoption of a taper seat and extended reach (threaded portion) or even the use of a smaller diameter is often the answer. Some engines require the use of two spark plugs per cylinder and again due to space restrictions these might be of different sizes.

Changes in fuelling systems and the fuel itself have meant some special features being adopted at the 'firing end' of the spark plug. Extra projected types push the spark position into the heart of the combustion chamber to promote better combustion of the fuel/air mixture, which is weaker than ever in an effort to improve economy. Modern engine manufacturers often require increased spark gaps to allow a longer spark duration, which again aids more efficient combustion.

To combat the 'cold fouling' effect that can occur in some engines using unleaded fuels specially arranged ground electrodes are sometimes used. These can force the spark to discharge across the insulator and thus burn away any built up carbon that could cause poor starting or misfires. It is not uncommon to find two, three or four ground electrode arrangements in new vehicles. The use of precious metals on the tips of the spark plug electrodes is not uncommon especially on higher performance engines. Whilst these spark plugs do have increased service life they are often specified because of their superior ignition qualities.

Our engineering departments work very closely with the engine and vehicle manufacturers to produce the ideal spark plug type for each application. Any change in production is expensive for a manufacturer and therefore new spark plug types are only produced where necessary. NGK employ the very latest production technology to ensure that every aspect is catered for – performance, economy and value.

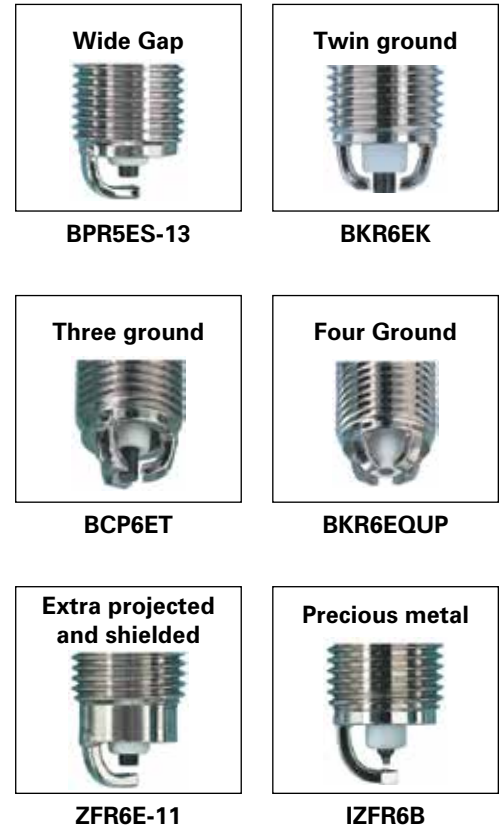

HEAT RANGE AND HEAT DISSIPATION

Spark plugs do not produce heat in the combustion chamber. One of the functions of the spark plug is to dissipate some of the heat produced during combustion. This is mostly transferred into the cylinder head. The 'Heat Range' indicates the measure of the spark plug's ability to do this.

A 'hot' spark plug is designed to maintain a sufficiently high temperature at the insulator nose to burn off carbon and oil deposits. A 'cold' spark plug is designed to allow a faster transfer of heat to the cylinder head thus preventing overheating and premature failure.

The heat range selection is obviously a complex task with many factors to take into account. NGK engineers therefore make specific recommendations for each engine and the use to which it is put.

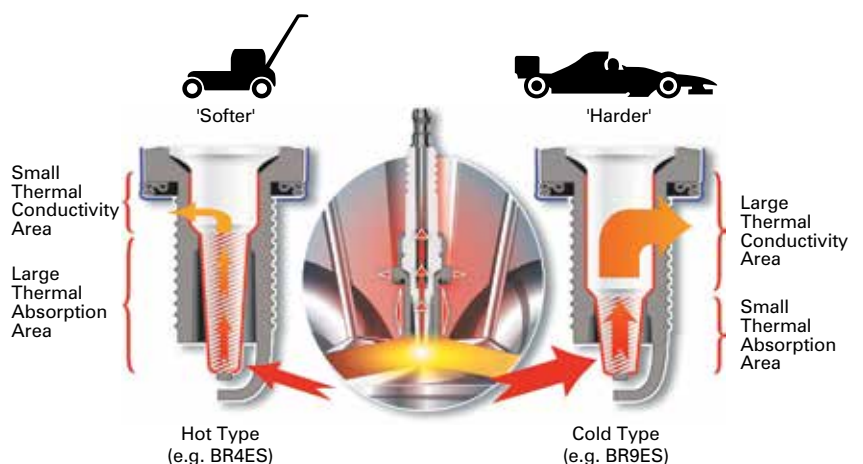

NGK'S COPPER CORE TECHNOLOGY

WIDE HEAT RANGE

A wide range spark plug is more flexible and performs equally well in a hot or cold engine under stop and go city driving or fast motorway cruising. Engines that tend to run hot need cold type plugs. Those that run cold demand a hotter type. The specific plug for any engine is determined by the plug's heat range. That is the minimum and maximum temperatures between which the plug will offer optimum performance.

The heat range of NGK Spark Plugs is wider than ordinary plugs therefore they are suitable for both high speed and low speed driving. Compared with conventional plugs of the same pre-ignition rating they have more resistance to fouling. Compared to ordinary plugs with equal anti-fouling resistance, NGK Spark Plugs have a higher pre-ignition rating.

NGK'S HEART OF COPPER

Copper wire used in place of the iron core in conventional plugs is the secret of NGK's Wide Heat Range. Copper's superior heat conductivity dissipates heat quicker. It cools the electrode tip and insulator tip which prevents hot spots that could cause pre-ignition. Increased heat resistance does not affect fouling resistance, which is primarily determined by the insulator nose length. The longer the nose, the more susceptible it is to heat and the more free from fouling. By raising the pre-ignition rating with the high conduction copper and leaving the insulator nose long, NGK produces the Wide Range Plug. One that meets the broad thermal requirements of engines under high and low RPM conditions. With the exception of a couple of older applications, all the spark plugs in this catalogue employ copper core technology.



FIRING END APPEARANCE

<p>Firing end temperature °C</p> <p>Overheating area</p> <p>870°</p>		<ul style="list-style-type: none"> • Overheating The insulator is white and sometimes blistered. If the insulator temperature is over 870°C pre-ignition may occur. Engine power will be reduced and the piston may be damaged. 	<ul style="list-style-type: none"> • Causes • Over advanced ignition timing • Too lean a fuel mixture • Blocked injectors • Insufficient cooling • Excessive deposits in the combustion chamber
<p>Optimum temperature area</p> <p>450°</p>		<ul style="list-style-type: none"> • Good condition The insulator is brown or light grey. 	<p>Even if the spark plug is used under good conditions, deposits will accumulate. Regular inspection and replacement is advisable.</p>
<p>Fouling area</p> <p>Idle Temp { 250° 150°</p>		<ul style="list-style-type: none"> • Fouling Carbon accumulates on the insulator nose forming a leakage path to earth. The engine misfires resulting in bad starting and poor acceleration. Particularly common with unleaded fuel. 	<ul style="list-style-type: none"> • Causes • Too rich a fuel mixture • Excessive use of choke • Prolonged slow speed driving or idling • Blocked air filter • Spark plug heat range too cold

THE BEST SPARK PLUG FOR EVERY OCCASION

As a result of our policy of continuous research and development NGK can offer special spark plugs designed to give optimum performance under a high range of conditions.

'S' TYPE (e.g. BP6ES)

NGK standard spark plugs with copper cored centre electrodes for wide heat range. Copper's superior heat conductivity dissipates the heat of combustion away from the firing end, preventing hot spots that can lead to pre-ignition. Copper cored electrodes also mean that longer insulator noses can be used to protect against fouling.

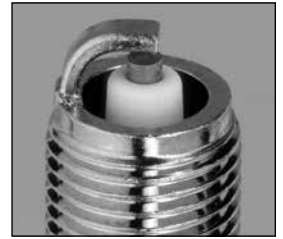

'G' TYPE (e.g. B10EG)

These plugs feature a smaller diameter centre electrode tip made of conventional nickel alloy. The smaller diameter centre electrode means the voltage required to produce a spark is reduced. However as the tip is made of conventional nickel alloy the service life is reduced and these plugs are best used in applications where plugs are frequently changed.



'V' TYPE (e.g. B10EV)

These 'V' types have been discontinued and replaced with 'VX' or 'IX' equivalents. The centre electrode of the 'V' type is made of gold palladium alloy.



'VX' TYPE (e.g. DR8EVX)

These plugs have an even smaller centre electrode (0.8mm) than the V types and this is made of platinum. This combined with a taper cut ground electrode means an even lower required voltage than the V types. The result is better ignitability along with improved starting, idle stability and anti-fouling performance. These 'VX' types have mostly been discontinued and replaced by the 'IX' types.



'IX' TYPE (e.g. BR8EIX)

Similar in design to the Platinum VX spark plug, the use of the precious metal Iridium allows us to manufacture a spark plug with an even smaller diameter centre electrode (0.6mm) without compromising durability. This extremely small Iridium tip centre electrode concentrates the available electrical energy and combined with the taper cut ground electrode provides the best performance in terms of starting, idling and especially throttle response.



FITTING THE CORRECT SPARK PLUG

NGK spark plugs are designed using the latest technology to give optimum performance over the engine's entire rev. range. Fitting the correct type of spark plug is essential. Many changes in engine technology has meant changes in spark plug design. Some NGK spark plugs may have a similar appearance, however the internal and or external design can differ sufficiently to cause engine damage should the incorrect part be installed. The examples below display some of the different design features employed in typical motorcycle applications and hopefully help to explain the reason for some application specific part numbers.

CR8EH-9

- Used on some Honda designed engines
- Special thread can only be used in specific engines or the cylinder head will be damaged

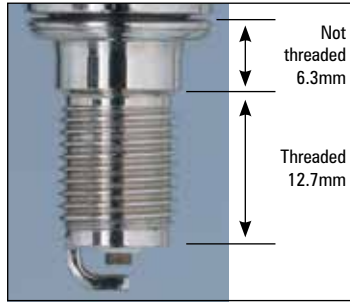

BR10ECM

- Compact style, mainly used by KTM and Suzuki
- For use where space is restricted

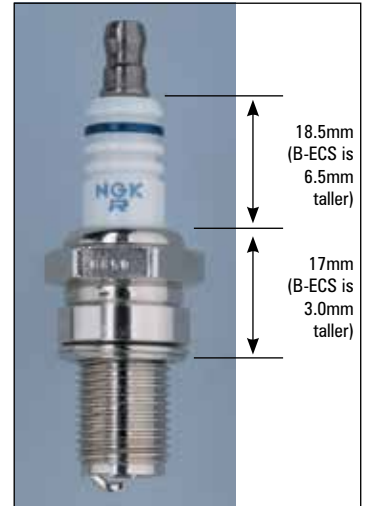

CR6HSA

- Centre electrode is 0.2mm wider than CR6HS for improved durability
- Short metal shell design



CR9EK, JR9C

- Used by Kawasaki and Suzuki
- 2 ground electrodes for improved durability



CR9EK thread diameter Ø 10mm



JR9C thread diameter Ø 12mm

ER9EH

- Used by Honda, Ø 8mm thread with 13mm hex
- Do not exceed the tightening torque of 0.8 - 1.0kg/m

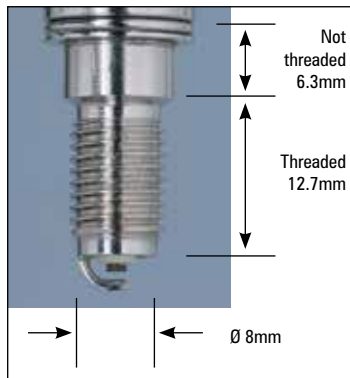

BR9ECS

- Short ground electrode for strength and to prevent overheating
- For competition use



THE IRIIDIUM IX SPARK PLUG

The Iridium IX spark plug is similar in design to the Platinum VX type but benefits from the use of the precious metal Iridium on its centre electrode. Iridium is harder than other precious metals used in spark plug manufacture, has an extremely high melting point and offers greater protection from chemical attack. These features allow the use of an extremely small diameter electrode (0.6mm) without compromising the spark plug's service life. Combined with the use of the taper cut ground electrode this spark plug has superior gas flow properties and lower voltage requirements, which offers further improvements in starting, idling and throttle response.

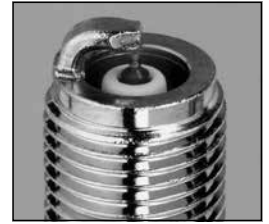

BR8EIX

Iridium spark plugs are used by some of the worlds leading race teams and as original equipment in many high performance road and off road machines. Owners who want the very best performance from their bikes will want the best spark plug and this we can offer with Iridium IX.

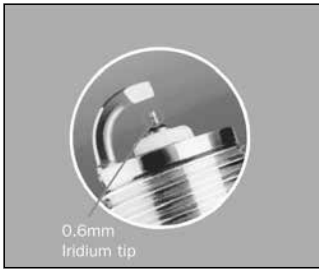

Iridium IX

A small diameter electrode that gives good gas flow and less restriction of flame kernel

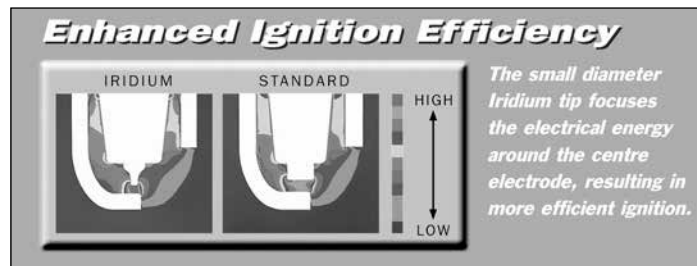

Iridium IX packaging

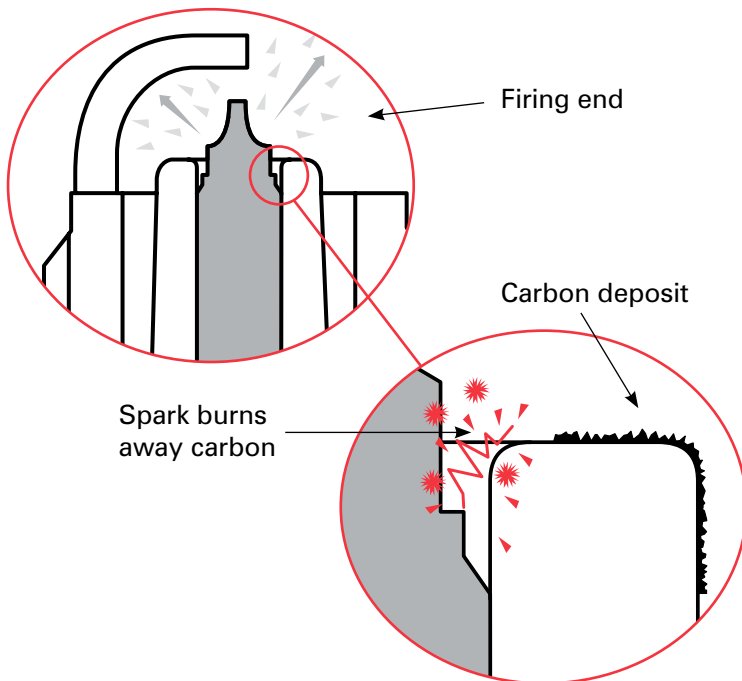

The close up section shows the annular gap between the centre electrode and insulator nose which provides cold fouling protection.

Should current try to leak away across a carbonised insulator a spark can occur between the electrode and the insulator thus burning away the carbon deposit.

THE IRIIDIUM IX SPARK PLUG

The tables below show the Iridium IX upgrade from standard copper core. For specific model application refer to the Iridium column in the main data pages.

STANDARD COPPER CORE		IRIDIUM IX	
PART NO.	PART NO.	PART NO.	STOCK NO.
BK6E	BKR6E	BKR6EIX	6418
	BKR6E-11	BKR6EIX-11	3764
	BKR7E	BKR7EIX	2667
BP5ES	BPR5ES	BPR5EIX	6597
BP6ES	BPR6ES	BPR6EIX	6637
	BPR6ES-11	BPR6EIX-11	3903
BP6HS	BPR6HS	BPR6HIX	4085
BP6HS-10	BPR6HS-10		
	BR6HSA		
BP7ES	BPR7ES	BPR7EIX	4055
BP7HS	BPR7HS	BPR7HIX	5944
BP7HS-10	BPR7HS-10		
BP8HS	BPR8HS	BPR8HIX	6742
BP8HS-10	BR8HSA		
B6HS	BR6HS	BR6HIX	3419
B6HS-10	BR6HS-10		
B7ES	BR7ES	BR7EIX	6664
B7HS	BR7HS	BR7HIX	7067
B7HS-10	BR7HS-10		
B8ES	BR8ES	BR8EIX	5044
B8HS	BR8HS	BR8HIX	7001
B8HS-10	BR8HS-10		
B9ES	BR9ES	BR9EIX	3981
	BR10ES	BR10EIX	6801
C6HSA	CR6HSA	CR6HIX	7274
	CR6HS		
	CR7E	CR7EIX	7385

STANDARD COPPER CORE		IRIDIUM IX	
PART NO.	PART NO.	PART NO.	STOCK NO.
C7HSA	CR7HSA	CR7HIX	7544
	CR7HS		
	CR8EH-9	CR8EHIX-9	3797
C8E	CR8E	CR8EIX	4218
	CR8EK		
C8HSA	CR8HSA	CR8HIX	7669
	CR8HS		
	CR9EH-9	CR9EHIX-9	6216
C9E	CR9E	CR9EIX	3521
	CR10E	CR10EIX	6482
	CR10EK		
	DCPR7E	DCPR7EIX	6046
	DCPR8E	DCPR8EIX	6546
	DCPR8EK		
	DCPR9E	DCPR9EIX	2316
	DPR7EA-9	DPR7EIX-9	7803
DP8EA-9	DPR8EA-9	DPR8EIX-9	2202
	DPR9EA-9	DPR9EIX-9	5545
D8EA	DR8EA	DR8EIX	6681
	DR8ES-L		
D9EA	DR9EA	DR9EIX	4772
	DR8ES*		
	JR9B		

*The upgrade from DR8ES to DR9EIX is correct

The IX range took over the premium motorcycle spark plug position from the popular Platinum VX range. Most contemporary machines demand the use of resistor types, and most older machines can and do use them quite happily.

Below is a chart to show the VX plugs affected.

Platinum VX		replaced by	Iridium IX	
Platinum VX	Stock No.		Iridium IX	Stock No.
B7EVX	6934	→	BR7EIX	6664
B7HVX	7836	→	BR7HIX	7067
B8EVX	7051	→	BR8EIX	5044
B8HVX	2634	→	BR8HIX	7001
B9EVX	7254	→	BR9EIX	3981
B10EVX	7335	→	BR10EIX	6801
B10HVX	2940	→	BR10HIX	6692
BKR6EVX	3539	→	BKR6EIX	6418
BKR7EVX	3544	→	BKR7EIX	2667
BP5EVX	5470	→	BPR5EIX	6597
BP7EVX	7270	→	BPR7EIX	4055
BPR5EVX	4875	→	BPR5EIX	6597
BPR6EVX	6764	→	BPR6EIX	6637

Platinum VX		replaced by	Iridium IX	
Platinum VX	Stock No.		Iridium IX	Stock No.
BPR9EVX	5576	→	BPR9EIX	6853
BR8EVX	1262	→	BR8EIX	5044
BR9EVX	1265	→	BR9EIX	3981
CR8EHVX-9	4546	→	CR8EHIX-9	3797
CR8EVX	6487	→	CR8EIX	4218
CR9EHVX-9	3872	→	CR9EHIX-9	6216
CR9EVX	5943	→	CR9EIX	3521
D8EVX	2850	→	DR8EIX	6681
D9EVX	2834	→	DR9EIX	4772
DCPR7EVX	1179	→	DCPR7EIX	6046
DPR7EVX-9	7682	→	DPR7EIX-9	7803
DPR8EVX-9	2872	→	DPR8EIX-9	2202
DPR9EVX-9	3854	→	DPR9EIX-9	5545

SPARK PLUG INSTALLATION TIPS

- Refer to current NGK catalogue for correct spark plug selection
- Check condition and cleanliness of threads in cylinder head
- Ensure plug is gapped according to vehicle manufacturers specification (*fig 1*)
- Multi ground electrode and precious metal plugs should not be regapped - visual inspection only
- Install new spark plug *by hand* until it seats - (*fig 2*) a length of rubber tubing pushed over the insulator can be a useful aid for plug installation where access is difficult
- Tighten to specified torque setting as shown in the chart below (*fig 3*)
- If a torque wrench is unavailable then refer to vehicle/engine manufacturers installation instructions or the tightening angle advice which is displayed on current NGK packaging (excluding specialist race plugs). Note that this angle advice can differ between part numbers due to individual spark plug design (e.g. seating type, thread diameter and gasket material)
- It is important not to over or under tighten spark plugs during installation. Over-tightening can lead to distortion of the spark plug. Under-tightening can cause overheating due to poor heat dissipation. *In extreme cases incorrect tightening can cause spark plug breakage and/or engine damage*
- NGK does not recommend the application of lubricant to spark plug threads as the resultant reduction of frictional forces at the thread faces will render the torque charts inaccurate and over tightening could occur
- If a gasket type spark plug is re-installed, it should only require a further 1/12 of a turn after it has been seated
- Always carefully use the correct tools for removal/installation to prevent damage to the spark plug or engine
- Inspect spark plug cover and renew if necessary

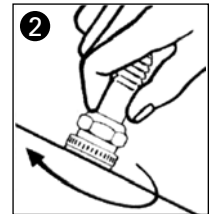
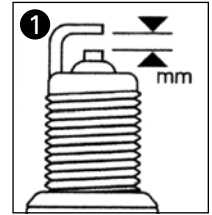

3	FOR FLAT SEAT TYPE (WITH GASKET)					TAPER SEAT TYPE		
	Thread Ø	18 mm	14 mm	12 mm	10 mm	8 mm	18 mm	12 & 14 mm
	Cast iron head	35-45Nm (3.5-4.5kgm) (25.3-32.5lbs ft)	25-35Nm (2.5-3.5kgm) (18.0-25.3lbs ft)	15-25Nm (1.5-2.5kgm) (10.8-18.0lbs ft)	10-15Nm (1.0-1.5kgm) (7.2-10.8lbs ft)	-	20-30Nm (2.0-3.0kgm) (14.5-21.6lbs ft)	15-25Nm (1.5-2.5kgm) (10.8-18.0lbs ft)
	Aluminium head	35-40Nm (3.5-4.0kgm) (25.3-28.9lbs ft)	25-30Nm (2.5-3.0kgm) (18.0-21.6lbs ft)	15-20Nm (1.5-2.0kgm) (10.8-14.5lbs ft)	10-12Nm (1.0-1.2kgm) (7.2-8.7lbs ft)	8-10Nm (0.8-1.0kgm) (5.8-7.2lbs ft)	20-30Nm (2.0-3.0kgm) (14.5-21.6lbs ft)	10-20Nm (1.0-2.0kgm) (7.2-14.5lbs ft)

Important: Some spark plugs differ in gasket design or material, refer to tightening advice on specific spark plug packaging

SPARK PLUG GAP SETTINGS

Important: Spark plug gap settings are given in millimetres. Practical equivalents are shown below.

mm	0.4	0.5	0.6	0.7	0.8	0.9	1.0	1.1	1.2	1.3	1.4	1.5	1.6	1.8
ins	.016	.020	.024	.028	.032	.035	.039	.043	.048	.051	.055	.059	.063	.071

DESIGN SYMBOLS

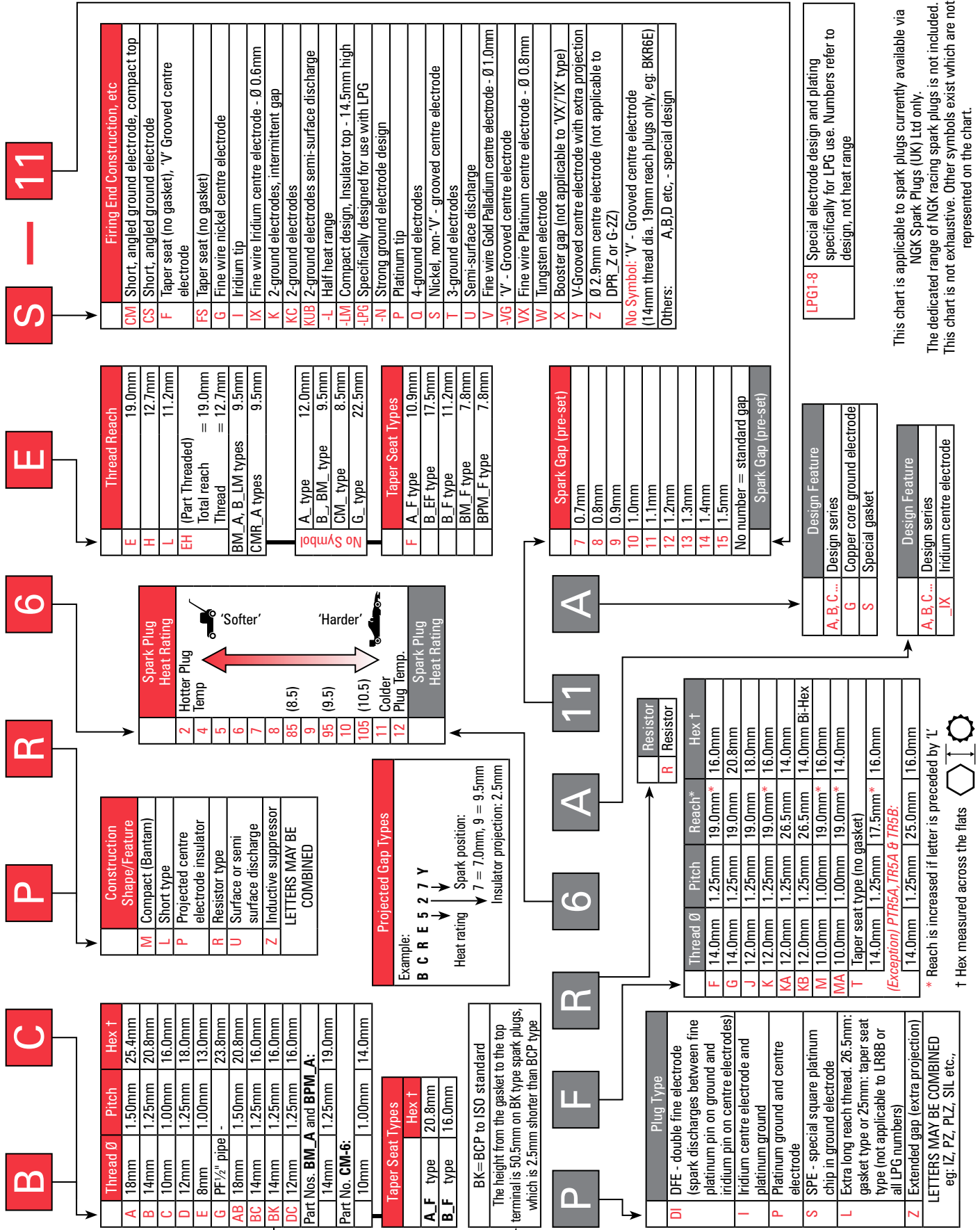

NEW ADDITIONS AND PART NUMBERS

These are new additions to this catalogue that have new part numbers not previously stocked by NGK Spark Plugs (UK) Ltd.

PART NO.	STOCK NO.	APPLICATION		PART NO.	STOCK NO.	APPLICATION	
CR6HSB-9	97276	HONDA	GL1800 Goldwing	MAR9A-6J	91321	HUSQVARNA	TR650 Strada, Terra
CR7EIA-9	91175	SUZUKI (Quads)	LT-F400FSi KingQuad	MR7G-9E	90312	HONDA	SH Mode 125
GR7CI-8	95476	BETA/BETAMOTOR	Evo 125, 200, 250, 300 Xtrainer	MR8BI-8	91360	APRILIA	Dorsoduro 900 Shiver 900
GR8DI-12	90908	HUSQVARNA	TX 150			PIAGGIO/VESPA	Liberty 50 Primavera 50 Zip 50
		KTM	150 EXC				
LKAR9BI-10	95371	KTM	1050 Adventure 1290 Super Adventure	MR8E-9	90527	SUZUKI	GSX-S125 SV650
LMAR7DI-10	96956	KTM	1050 Adventure 1290 Super Adventure	MR8F	90299	POLARIS	RZR XP 15→16
LMAR8EI-7	92499	PIAGGIO/VESPA	Medley 125, 150 Vespa GTS 125, 150	MR9F	95424	POLARIS	RZR XP 17→
LMAR8J-9E	93972	BMW	C 400 X F 750 GS F 850 GS	MR9K-9	97162	YAMAHA	MXT850 Niken
				SILMAR8A9S	90992	HONDA	CRF1000L Africa
				SILMAR9E9	95123	KAWASAKI	ZR1000KLFA ZX1002 Ninja
LMAR9FI-10G	92850	BMW	S1000RR	ZGR7GI-13G	96760	HUSQVARNA	TE250 TE300
LMAR9G	97476	KAWASAKI	Ninja 400			KTM	250 EXC 300 EXC
LMDR10A-JS	97718	DUCATI	Panigale V4				
LZMAR8BI-10	95680	KTM	450, 500 EXC-F, Six Days				

These Spark Plugs will become available during 2020

Listed below is a selection of new applications for existing spark plugs

MAKE	MODEL	PART NO.	STOCK NO.
AJS	Eco-2, Eco-3 125	CR6HSA	2983
AUSA (Quads)	Task M50	DCPR8E	4179
BAJAJ	Pulsar AS200, NS200 (Triple Spark)	CR8E	1275
	Pulsar AS200, NS200 (Triple Spark)	LKAR8A-9	4786
BENELLI	124	C7HSA	4629
	Leoncino, Leoncino Trail	CR8E	1275
	TRK502/X	CR8E	1275
BETA / BETAMOTOR	EVO 300 4T	MR7BI-8	90982
BMW	C 400 GT	LMAR8J-9E	93972
	G310 GS	LMAR9D-J	1633
	R850RT	BKR7EKC	7354
	R1250	LMAR8AI-10	94319
CUSHMAN (Quads)	Hauler 4x4 (720cc EFi)	BPR5ES	7422
DERBI	Senda DRD 125 4S 4V R	CR8EB	7784
DUCATI	Diavel 1260, 1260S	MAR9A-J	6869
	Hypermotard 950	MAR9A-J	6869
	Multistrada 950 (Twin Spark)	MAR9A-J	6869
	Multistrada 1260 Enduro (Twin Spark)	MAR9A-J	6869
	Multistrada 1260 S, S Grand Tour	MAR9A-J	6869
	Panigale V4R	LMDR10A-JS	97718
	Panigale V4 Anniversario 916	LMDR10A-JS	97718
	Scrambler 1100	DCPR8E	4339

MAKE	MODEL	PART NO.	STOCK NO.
E-Z-GO (Quads)	Hauler 4x4 (720cc EFi)	BPR5ES	7422
GAS GAS	EC 300	BR8EG	3130
HARLEY DAVIDSON	1745cc (Twin spark)	CR9E	6263
	Street 500	CR8E	1275
	Street 750	CR8E	1275
HONDA	C125 Super Cub	CPR6EA-9	6899
	CB175	D8HA	7112
	CB300R Neo Sports Café	SIMR8A9	91064
	CB1000R Neo Sports Café	IMR9E-9HES	7556
	CRF250RX	R0451B-8	9356
	CRF450L	SILMAR9A9S	6213
	CRF450RX	SILMAR9A9S	6213
	Monkey 125	CPR6EA-9	6899
	XR250	CR9EH-9	7502
	HONDA (Quads)	SXS 700 M2, M4 Pioneer	BKR5E-11
TRX450-ER Sportrax		IFR7L11	5114
TRX520 Fourtrax, Foreman		BKR5E-11	6953
HUSQVARNA	701 Enduro (Twin spark)	LMAR7DI-10	96956
	701 Enduro (Twin spark)	LKAR9BI-10	95371
	FE350	LMAR9AI-10	93188
	TX125	BR9ECMIX	2707
	TC250 (2-Stroke)	BR8ECM	3035
INDIAN	Scout, Scout Sixty	MR7F	95897
JOHN DEERE (Quads)	XUV 590i	BKR6EIX-11	3764
	XUV 825i	BKR6EIX-11	3764

The above tables are intended as a stock purchase guide.
Refer to the relevant model listing in the main application section for product selection.

NEW ADDITIONS AND PART NUMBERS

MAKE	MODEL	PART NO.	STOCK NO.
KAWASAKI	BR125	LMAR8G	95627
	BX125 Ninja	LMAR8G	95627
	EJ800A Café, Street	CR8E	1275
	KX252 (KX250F)	CPR8EB-9	6607
	KX252 (KX250)	CR9EIB-9	92579
	KX450	CPR8EB-9	6607
	Z900	CR9EIA-9	6289
	ZX1002 CJF (Ninja ZX-10R SE)	SILMAR9B9	95399
ZX1002KLFA (Ninja 1000SX)	CR9EIA-9	6289	
KAWASAKI (Quads)	KAF400 Pro-SX	BPR5ES	7422
	KAF700 Pro-MX	CR7E	4578
	KVF750 Brute Force 750 2014	CR7E	4578
	KVF750 Brute Force 750 15→	CPR7EA-9	3901
KTM	450 EXC-F, Six Days	LMAR9AI-10	93188
	450 RALLY Replica 15→17	LKAR8AI-9	6706
	450 RALLY Replica 19→	LMAR9AI-10	93188
	450 SMR	LKAR8AI-9	6706
	450 SX-F	LMAR9AI-8	97225
	500 EXC-F	LMAR9AI-10	93188
	790 Adventure, R, Rally	LMAR9AI-10	93188
	790 Duke	LMAR9AI-10	93188
	890 Duke R	LMAR9AI-10	93188
	Duke 390	LKAR8A-9	4786
	Freeride 250-F	LMAR9AI-10	93188
	RC200	LKAR8A-9	4786
	RC390	LKAR8A-9	4786
	LEXMOTO	Diablo LJ125T-8M	CR7HSA
Hunter		CR7HSA	4549
MOTO GUZZI	254	C7HSA	4629
PEUGEOT	Vivacity 125	CR7HSA	4549

MAKE	MODEL	PART NO.	STOCK NO.
PIAGGIO / VESPA	Liberty 50 4-Stroke	CR8EB	7784
	Primavera 50 4-Stroke	ER9EH-6N	1673
POLARIS (Quads)	Sportsman XP 850	LZKAR7B	5942
RIEJU	Marathon 125cc (Endura / Pro / SM)	CR8E	1275
	Marathon, Marathon Pro 200cc	CR8E	1275
SCORPA	125 Twenty	BP5ES	6511
SHERCO	80 ST	BP5ES	6511
	125 SE-R	BR9ECMIX	2707
	250 SE-R	BR8ES	5422
	300 SE-R	BR8ES	5422
SUZUKI	DL250 V-Strom	CPR7EA-9	3901
	DL650AL7 (Twin Spark)	MR8E-9	90527
	GSX250R	CPR7EA-9	3901
	GSX-R125	MR8E-9	90527
	GSX-S750	CR9EIA-9	6289
	GSX-R1000	CR9EIA-9	6289
	V-STROM 1050 (Twin Spark)	LMAR8BI-9	91909
	TM RACING	MX 85	BR9EG
MX 100		BR9EG	3230
TRIUMPH 1991-ON	Daytona Moto2 765	CR9EIA-9	6289
	Scrambler 1200 XC, XE	LMAR8A-9	4313
	Street Scrambler	LMAR8A-9	4313
	Speed Triple RS, S	CR9EIA-9	6289
	Speed Twin	LMAR8A-9	4313
YAMAHA	MT-09	CPR9EA-9	2308
	Tracer 900	CPR9EA-9	2308
	XVS950XR SCR950	CPR7EA-9	3901
	YZ65	BR9ECM	3252
YAMAHA (Quads)	Drive2 EFi, Carb	BPR2ES	2264
	YFM700FWA Grizzly 700 EPS	CPR7EA-9	3901

The above tables are intended as a stock purchase guide.
Refer to the relevant model listing in the main application section for product selection.



CC	MODEL	DATE	STANDARD COPPER CORE	STOCK NUMBER	PLATINUM OR GOLD PALLADIUM	STOCK NUMBER	IRIDIUM	STOCK NUMBER	GAP MM
ADLY									
50	Citybird, Crosser, Fox, Jet X1, Pista, Predator	97→	BPR7HS	6422			BPR7HIX	5944	0.6
100	Cat, Predator, Jet, X1	97→	BPR7HS	6422			BPR7HIX	5944	0.6
125	Activator 125	99→	CR7HSA	4549			CR7HIX	7544	0.5
	AJP 125 PR4	03→	DPR7EA-9	5129			DPR7EIX-9	7803	0.9
	Cat 125	97→	CR7HSA	4549			CR7HIX	7544	0.5

AJS									
50	Chipmunk 50	03→	BP4HS	3611					0.6
	DD50 Regal Raptor	03→	CR7HS	7223			CR7HIX	7544	0.7
	JSM 50 Motard	11→	BR8ES	5422			BR8EIX	5044	0.6
80	Coyote 80	03→	BP6HS	4511			BPR6HIX	4085	0.6
100	Cougar 100 (Jincheng)	03→	BP7HS	5111			BPR7HIX	5944	0.6
	DD100 Regal Raptor	03→	CR7HS	7223			CR7HIX	7544	0.7
125	CR3-125 Super Sports	08→	DR8EA	7162	DR8EVX	6354	DR8EIX	6681	0.6
	Eco-2 125	11→15	CR6HSA	2983			CR6HIX	7274	0.6
	Eco-3 125	16→	CR6HSA	2983			CR6HIX	7274	0.6
	JS125Y Tiger	03→	DR8ES	5423			DR9EIX	4772	0.7
	JSM125 Motard / Trail	10→	CR6HSA	2983			CR6HIX	7274	0.6

APRILIA									
50	AF1 50	88→92	B8ES	2411			BR8EIX	5044	0.5
	Amico 50	92→94	BR7HS	4122			BR7HIX	7067	0.6
	Area 51 (Liquid Cooled 2-Stroke)	98→	BR8HS	4322			BR8HIX	7001	0.5
	Extrema 50	93→	B8ES	2411			BR8EIX	5044	0.5
	Gulliver	97→99	BR7HS	4122			BR7HIX	7067	0.6
	Habana 50, Custom & Retro	99→05	BPR8HS	3725			BPR8HIX	6742	0.6
	Mojito Custom 50	05→08	BR9ES	5722			BR9EIX	3981	0.7
	MX50	03→07	BR9ES	5722			BR9EIX	3981	0.7
	Rally 50 (Air Cooled)	95→99	BR7HS	4122			BR7HIX	7067	0.7
	Rally 50 (Liquid Cooled)	97→03	BR8HS	4322			BR8HIX	7001	0.5
	Red Rose 50	93→00	B8ES	2411			BR8EIX	5044	0.5
	RS 50 (Minarelli engine)	93→00	B8ES	2411			BR8EIX	5044	0.6
	RS 50 (Minarelli engine)	01→05	BR9ES	5722			BR9EIX	3981	0.7
	RS 50 (Derbi engine)	06→	BR9ES	5722			BR9EIX	3981	0.5
	RS4 50	11→13	BR8ES	5422			BR8EIX	5044	0.6
	RX 50 (Minarelli engine)	97→10	B9ES	2611			BR9EIX	3981	0.6
	Scarabeo 50 Carb (Minarelli engine) 12.7mm Thread Reach	93→04	BR7HS	4122			BR7HIX	7067	0.6
	Scarabeo 50 Carb (Piaggio engine) 19mm Thread Reach	05→11	BR8ES	5422			BR8EIX	5044	0.6
	Scarabeo 50 Di Tech (Injection) 2-Stroke	01→04	CPR8E	7411			CR8EIX	4218	0.8
	Scarabeo 50 4T (4-Stroke) 2-valve Ø10mm Plug	06→09	CR9EB	6955			CR9EIX	3521	0.6
	Scarabeo 50 4T (4-Stroke) 4-valve Ø8mm Plug	08→12	ER9EH-6N	1673					0.6
	Sonic FT 50 (Air Cooled 2-Stroke)	98→01	BR8HS	4322			BR8HIX	7001	0.5
	Sonic GP 50 (Liquid Cooled 2-Stroke)	98→05	BR8HS	4322			BR8HIX	7001	0.5
	Sportcity One (4-Stroke)	08→11	CR8EB	7784			CR8EIX	4218	0.7
	Sportcity One Street (2-Stroke)	08→11	BR9ES	5722			BR9EIX	3981	0.6
	SR 50 (Air Cooled)	94→	BR7HS	4122			BR7HIX	7067	0.7
	SR 50 Stealth / LC / Racing (Liquid Cooled)	96→	BR7HS	4122			BR7HIX	7067	0.7
	SR 50 Carb (19mm Thread Reach)	04→	BR9ES	5722			BR9EIX	3981	0.6
	SR 50 Di Tech Injection	01→04	CPR8E	7411			CR8EIX	4218	0.8
	SR 50 Di Tech Injection	05→				ZMR7AP	6914		0.8
	SR 50 i.e. Pure Jet	04→				ZMR7AP	6914		0.8
	SR 50 WWW	01→02	BR7HS	4122			BR7HIX	7067	0.6
	SR 50R	05→	BR9ES	5722			BR9EIX	3981	0.6
	SR Motard 50 (2-Stroke)	12→	BR9ES	5722			BR9EIX	3981	0.5
SX 50	06→10	BR9ES	5722			BR9EIX	3981	0.6	
100	Scarabeo 100 2-Stroke (12.7mm Thread Reach)	99→01	BR8HS	4322			BR8HIX	7001	0.6
	Scarabeo 100 4-Stroke (19mm Thread Reach)	01→12	CR9EB	6955			CR9EIX	3521	0.5
125	AF1 125	88→93	BR10EG	3830			BR10EIX	6801	0.5
	AF1 Futura	90→93	BR10EG	3830			BR10EIX	6801	0.5
	Atlantic 125	03→13	CR8EB	7784			CR8EIX	4218	0.8
	Classic 125	99→06	BR10EG	3830			BR10EIX	6801	0.6



CC	MODEL	DATE	STANDARD COPPER CORE	STOCK NUMBER	PLATINUM OR GOLD PALLADIUM	STOCK NUMBER	IRIDIUM	STOCK NUMBER	GAP MM
APRILIA (CONTINUED)									
125	ETX 125 (Liquid Cooled 2-Stroke)	98→01	BR8ES	5422			BR8EIX	5044	0.5
	Europa 125	90→92	BR10EG	3830			BR10EIX	6801	0.5
	Habana 125 Custom & Retro (4-Stroke)	99→	CR8E	1275			CR8EIX	4218	0.6
	Leonardo 125	95→98	CR8E	1275			CR8EIX	4218	0.6
	Leonardo 125 & ST	99→04					CR8EIX	4218	0.6
	Mojito Custom 125	05→	CR7EB	4663			CR7EIX	7385	0.6
	MX125	04→07	BR8ES	5422			BR8EIX	5044	0.6
	Pegaso 125	92→96	BR10EG	3830			BR10EIX	6801	0.5
	Rally 125	89→90	B10EG	3630			BR10EIX	6801	0.5
	Red Rose 125	88→94	BR10EG	3830			BR10EIX	6801	0.5
	RS 125 (12BHP Restricted)	93→12	BR8ES	5422			BR8EIX	5044	0.5
	RS 125 (35BHP Unrestricted)	93→12	BR10EG	3830			BR10EIX	6801	0.5
	RS 125R Extrema (12BHP Restricted)	93→12	BR8ES	5422			BR8EIX	5044	0.5
	RS 125R Extrema (35BHP Unrestricted)	93→12	BR10EG	3830			BR10EIX	6801	0.5
	RS125 Tuono	03→12	BR8ES	5422			BR8EIX	5044	0.6
	RS4 125	11→	CR9EB	6955			CR9EIX	3521	0.5
	RX125	94→96	BR10EG	3830			BR10EIX	6801	0.5
	RX125 (15BHP Restricted)	08→	BR8ES	5422			BR8EIX	5044	0.7
	RX125 (22BHP Unrestricted)	08→	BR10EG	3830			BR10EIX	6801	0.7
	Scarabeo 125cc (4-Stroke)	99→06	CR8E	1275			CR8EIX	4218	0.6
	Scarabeo 125cc (4-Stroke)	07→10			PMR9B	4717	CR9EIX	3521	0.7
	Sport City 125	04→08	CR8E	1275			CR8EIX	4218	0.6
	Sportcity Cube 125	08→11	CR7EB	4663			CR7EIX	7385	0.7
	Sportcity One 125	08→11	CR7EB	4663			CR7EIX	7385	0.7
	Sport Pro 125	92→93	BR10EG	3830			BR10EIX	6801	0.5
	SR 125	04/99→	BR8ES	5422			BR8EIX	5044	0.5
	SR 125AC	00→	BR8ES	5422			BR8EIX	5044	0.5
	SR MAX 125	11→	CR8EKB	4374			CR8EIX	4218	0.7
	SR Motard 125	12→	CR7EB	4663			CR7EIX	7385	0.7
	SX125 (15BHP Restricted)	08→	BR8ES	5422			BR8EIX	5044	0.7
SX125 (22BHP Unrestricted)	08→	BR10EG	3830			BR10EIX	6801	0.7	
Tuareg Wind 125	89→91	B10EG	3630			BR10EIX	6801	0.5	
150	Leonardo 150	98→01	CR8E	1275			CR8EIX	4218	0.6
	Leonardo 150 ST	02→04					CR8EIX	4218	0.6
	Scarabeo 150 (4-Stroke)	99→	CR8E	1275			CR8EIX	4218	0.6
200	Atlantic 200	03→07	CR8EB	7784			CR8EIX	4218	0.8
	Scarabeo 200 (4-Stroke)	00→06	CR8E	1275			CR8EIX	4218	0.6
	Scarabeo 200 (4-Stroke)	07→10			PMR9B	4717	CR9EIX	3521	0.7
	Sportcity 200	04→08	CR7EB	4663			CR7EIX	7385	0.6
	Sportcity Cube 200	08→	CR7EB	4663			CR7EIX	7385	0.7
250	Atlantic 250	04→08	CR8EB	7784			CR8EIX	4218	0.7
	Leonardo 250	99→03	DR8EA	7162	DR8EVX	6354	DR8EIX	6681	0.6
	RS 250	94→04	BR9ECM	3252			BR9ECMIX	2707	0.7
	Scarabeo 250	04→06	CR8EB	7784			CR8EIX	4218	0.7
	Scarabeo 250	07→09			PMR8B	6378			0.7
	Sport City 250	04→10	CR8EB	7784			CR8EIX	4218	0.7
280	Climber trials bike	89→					BPR6EIX	6637	0.6
300	Leonardo 300	04→	DR8EA	7162	DR8EVX	6354	DR8EIX	6681	0.6
	Sportcity Cube	08→	CR8EKB	4374			CR8EIX	4218	0.7
	SR MAX 300	11→	CR8EKB	4374			CR8EIX	4218	0.7
400	Atlantic 400 Sprint	06→10	CR7EKB	4455			CR7EIX	7385	0.8
450	MXV 450	09→10	CR8EKB	4374			CR8EIX	4218	0.7
	RXV 4.5	06→08	CR8EB	7784			CR8EIX	4218	0.7
	RXV 4.5	09→	CR8EKB	4374			CR8EIX	4218	0.7
	SXV 4.5	06→08	CR8EB	7784			CR8EIX	4218	0.7
	SXV 4.5	09→	CR8EKB	4374			CR8EIX	4218	0.7
500	Atlantic 500	01→10	CR7EKB	4455			CR7EIX	7385	0.8
	Atlantic 500 Sprint	05→10	CR7EKB	4455			CR7EIX	7385	0.8
	Scarabeo 500	03→08	CR7EKB	4455			CR7EIX	7385	0.8
550	RXV 5.5	06→08	CR8EB	7784			CR8EIX	4218	0.7
	RXV 5.5	09→	CR8EKB	4374			CR8EIX	4218	0.7
	SXV 5.5	06→08	CR8EB	7784			CR8EIX	4218	0.7
	SXV 5.5	09→	CR8EKB	4374			CR8EIX	4218	0.7



CC	MODEL	DATE	STANDARD COPPER CORE	STOCK NUMBER	PLATINUM OR GOLD PALLADIUM	STOCK NUMBER	IRIDIUM	STOCK NUMBER	GAP MM
APRILIA (CONTINUED)									
600	Pegaso 600	92→94	D8EA	2120	DR8EVX	6354	DR8EIX	6681	0.6
	Tuareg 600	88→92	D8EA	2120	DR8EVX	6354	DR8EIX	6681	0.6
650	Moto 6.5 (650)	95→03	D8EA	2120	DR8EVX	6354	DR8EIX	6681	0.7
	Pegaso 650 (Carburettor)	93→00	D8EA	2120	DR8EVX	6354	DR8EIX	6681	0.6
	Pegaso 650 (Injection) Ø12mm Plug	01→04	DR8EB	4855	DR8EVX	6354	DR8EIX	6681	0.7
	Pegaso Strada & Trail 650 Ø10mm Plug	05→09	CR7E	4578			CR7EIX	7385	0.7
	Pegaso Factory	02/07→09	CR7E	4578			CR7EIX	7385	0.7
750	Shiver GT (Half faired) (Incl. ABS)	09→16	CR7EKB	4455			CR7EIX	7385	0.8
	SL 750 Shiver (Incl. ABS)	07→16	CR7EKB	4455			CR7EIX	7385	0.8
	SMV 750 Dorsoduro / Factory	07→16	CR7EKB	4455			CR7EIX	7385	0.8
839	Mana GT ABS (Twin Spark)	09→	CR7EKB	4455			CR7EIX	7385	0.8
	NA 850 Mana (Incl. ABS) (Twin Spark)	08→	CR7EKB	4455			CR7EIX	7385	0.8
	SRV850 (Twin Spark)	12→	CR7EKB	4455			CR7EIX	7385	0.8
896	Dorsoduro 900	18→					MR8BI-8	91360	0.8
	Shiver 900	17→					MR8BI-8	91360	0.8
1000	ETV 1000 Caponord	01→	DCPR9E	2641			DCPR9EIX	2316	0.6
	RST 1000 Futura	01→03	DCPR9E	2641			DCPR9EIX	2316	0.6
	RSV 1000 R Factory	04→	DCPR9E	2641			DCPR9EIX	2316	0.6
	RSV 4 Factory	09→14	CR9EB	6955			CR9EIX	3521	0.7
	RSV 4 R	09→14	CR9EB	6955			CR9EIX	3521	0.7
	RSV 4 RF	15→	CR9EKB	2305			CR9EIX	3521	0.8
	RSV Mille	98→	DCPR9E	2641			DCPR9EIX	2316	0.6
	RSV Mille R	98→03	DCPR9E	2641			DCPR9EIX	2316	0.6
	RSV Mille R	04→	DCPR9E	2641			DCPR9EIX	2316	0.6
	RSV Mille SP (Sport Production)	00→03	R0045Q-10	4216					1.1
	RSV Mille Tuono	02→	DCPR9E	2641			DCPR9EIX	2316	0.6
	SL 1000 Falco	99→06	DCPR9E	2641			DCPR9EIX	2316	0.6
	Tuono 1000	04→	DCPR9E	2641			DCPR9EIX	2316	0.6
	Tuono 1000 R	05→	DCPR9E	2641			DCPR9EIX	2316	0.6
Tuono V4R	05/11→14	CR9EKB	2305			CR9EIX	3521	0.8	
1077	Tuono V4 1100 RR	15→	CR9EKB	2305			CR9EIX	3521	0.8
1197	1200 Dorsoduro	11→	CR8EKB	4374			CR8EIX	4218	0.7
	Caponord (Twin Spark)	13→	CR8EKB	4374			CR8EIX	4218	0.7
	Caponord Rally (Twin Spark)	15→	CR8EKB	4374			CR8EIX	4218	0.7

ATALA									
50	Byte	97→98	B7HS	5110			BR7HIX	7067	0.5
	Carosello	97→00	B7HS	5110			BR7HIX	7067	0.5
	Hacker AT 12, Hacker Racing	97→98	BPR6HS	7022			BPR6HIX	4085	0.6
	Master	98→99	B6HS	4510			BR6HIX	3419	0.6
	Skeggia	99→00	BPR6HS	7022			BPR6HIX	4085	0.6

BAJAJ									
50	Sunny, Bonnie 50	93→	B6HS	4510			BR6HIX	3419	0.5
100	KB100	93→	B8ES	2411			BR8EIX	5044	0.5
125	Vespa, Chetak (Scooter)	93→	B6HS	4510			BR6HIX	3419	0.5
150	Chetak 150	01→	BPR5HS	6222					0.7
200	Pulsar 200 NS (Triple Spark)	13→14	Ø10mm Plug x 2	CR8E	1275		CR8EIX	4218	0.7
			Ø12mm Plug x 1	LKAR8A-9	4786		LKAR8AI-9	6706	0.9
	Pulsar AS200 (Triple Spark)	15→16	Ø10mm Plug x 2	CR8E	1275		CR8EIX	4218	0.7
			Ø12mm Plug x 1	LKAR8A-9	4786		LKAR8AI-9	6706	0.9
Pulsar NS200 (Triple Spark)	17→	Ø10mm Plug x 2	CR8E	1275		CR8EIX	4218	0.7	
			Ø12mm Plug x 1	LKAR8A-9	4786		LKAR8AI-9	6706	0.9

BAOTIAN									
50	BT49QT-9 / -11 / -12 Ø10mm Plug	04→	CR7HSA	4549			CR7HIX	7544	0.6
110	BT110-2	04→	CR7HSA	4549			CR7HIX	7544	0.6
125	Citibike 125	04→	CR7HSA	4549			CR7HIX	7544	0.6
	Monza 125	11→	CR7HSA	4549			CR7HIX	7544	0.6
	Tanco 125	04→	CR7HSA	4549			CR7HIX	7544	0.6



CC	MODEL	DATE	STANDARD COPPER CORE	STOCK NUMBER	PLATINUM OR GOLD PALLADIUM	STOCK NUMBER	IRIDIUM	STOCK NUMBER	GAP MM
BAROSSA									
125	XS125T-13	12/07→	CR7HSA	4549			CR7HIX	7544	0.6

BASHAN									
110	BS110 GY	01→	C7HSA	4629			CR7HIX	7544	0.6
125	BS125 GY	01→	D8EA	2120	DR8EVX	6354	DR8EIX	6681	0.6
200	BS200 GY	01→	D8EA	2120	DR8EVX	6354	DR8EIX	6681	0.6
250	Vixen VX250	06→	DR8EA	7162	DR8EVX	6354	DR8EIX	6681	0.7

BATAVUS									
50	Mondial	80→	B6HS	4510			BR6HIX	3419	0.4
	Starglo	76→	B7HS	5110			BR7HIX	7067	0.5

BEELINE									
50	Veloce GT 50	09→	C7HSA	4629			CR7HIX	7544	0.6
	Veloce Racing	09→	C7HSA	4629			CR7HIX	7544	0.6

BENELLI									
50	491 Sport, ST GP, Rage, RR SBK, RR GP	98→	BR8HS	4322			BR8HIX	7001	0.5
	49X Quattro Nove	08→	BR8HSA	5539			BR8HIX	7001	0.8
	49X Road	08→	BR8HSA	5539			BR8HIX	7001	0.8
	49X Trek	08→	BR8HSA	5539			BR8HIX	7001	0.8
	50 Cross	64→	B6ES	7310					0.5
	G2	75→80	B6ES	7310					0.5
	G2 Elle	75→80	B6ES	7310					0.5
	K2, K2 Air	98→	BR8HS	4322			BR8HIX	7001	0.5
	Motorella	65→	B6ES	7310					0.5
	Namur 50	98→01	BR8HS	4322			BR8HIX	7001	0.5
	Pepe	00→	BR8HS	4322			BR8HIX	7001	0.5
100	K2 100	99→	BR8HS	4322			BR8HIX	7001	0.5
124	124	80→86	C7HSA	4629			CR7HIX	7544	0.5
125	125 Roadster/Cross	71→	B7ES	1111			BR7EIX	6664	0.5
	Adiva	01→06	CR8EB	7784			CR8EIX	4218	0.8
	TnT 125	17→	CR7HSA	4549			CR7HIX	7544	0.6
	Velvet 125	99→	CR8E	1275			CR8EIX	4218	0.6
150	Adiva 150	01→06	CR8E	1275			CR8EIX	4218	0.6
231	250 Quattro (4-cyl.)	76→77	C7HSA	4629			CR7HIX	7544	0.5
	254	77→83	C7HSA	4629			CR7HIX	7544	0.5
	304	84→88	C7HSA	4629			CR7HIX	7544	0.5
250	250 Super	72→	B8ES	2411			BR8EIX	5044	0.5
	Adiva 250	08→	CR8EB	7784			CR8EIX	4218	0.8
	Cafénero 250	12→	CR8E	1275			CR8EIX	4218	0.6
	Velvet 250	00→	CR8E	1275			CR8EIX	4218	0.6
300	BN 302	14→	CR9EB	6955			CR9EIX	3521	0.7
350	354 Sei	80→	D8EA	2120	DR8EVX	6354	DR8EIX	6681	0.5
400	Velvet 400	03→04	CR9E	6263			CR9EIX	3521	0.7
500	Leoncino, Leoncino Trail	18→	CR8E	1275			CR8EIX	4218	0.6
	Quattro 500	73→83	D8EA	2120	DR8EVX	6354	DR8EIX	6681	0.5
	TRK502	17→	CR8E	1275			CR8EIX	4218	0.6
	TRK502X	18→	CR8E	1275			CR8EIX	4218	0.6
600	BN 600 GT	14→	CR9E	6263			CR9EIX	3521	0.7
	BN 600 I	14→	CR9E	6263			CR9EIX	3521	0.7
	BN 600 R	14→	CR9E	6263			CR9EIX	3521	0.7
650	654 Sei	80→	D8EA	2120	DR8EVX	6354	DR8EIX	6681	0.5
750	750 Sei	72→78	D8EA	2120	DR8EVX	6354	DR8EIX	6681	0.5
900	900 Sei	79→	D8EA	2120	DR8EVX	6354	DR8EIX	6681	0.5
	TNT 899/S/T (Tornado Naked Tre)	08→	CR9E	6263			CR9EIX	3521	0.7
	Tornado Tre 900/903 RS	02→	CR9E	6263			CR9EIX	3521	0.7
	Tornado Tre 903	08→	CR9EB	6955			CR9EIX	3521	0.7
	Tre-K 899	09→	CR9EB	6955			CR9EIX	3521	0.7



CC	MODEL	DATE	STANDARD COPPER CORE	STOCK NUMBER	PLATINUM OR GOLD PALLADIUM	STOCK NUMBER	IRIDIUM	STOCK NUMBER	GAP MM
BENELLI (CONTINUED)									
1130	TNT R160	10→	CR9EB	6955			CR9EIX	3521	0.7
	TNT 1130, K	04→	CR9E	6263			CR9EIX	3521	0.7
	TNT 1130 Titanium	06→	CR9E	6263			CR9EIX	3521	0.8
	TNT 1130 Sport Evo (Tornado Naked Tre)	07→	CR9E	6263			CR9EIX	3521	0.8
	TNT Café Racer 1130	01/06→	CR9E	6263			CR9EIX	3521	0.8
	Tornado Tre 1130	06→	CR9E	6263			CR9EIX	3521	0.7
	Tornado Tre K	06→	CR9E	6263			CR9EIX	3521	0.7
	Tre-K 1130K (Incl. Amazonas)	07→	CR9EB	6955			CR9EIX	3521	0.7

BENZHOU									
50	YY50QT	08→	CR7HSA	4549			CR7HIX	7544	0.6
125	YY125T		CR7HSA	4549			CR7HIX	7544	0.6
150	YY150		CR7HSA	4549			CR7HIX	7544	0.6
250	YY250	07→	DR8EA	7162	DR8EVX	6354	DR8EIX	6681	0.6

BETA / BETAMOTOR									
50	Ark (Air Cooled)	98→	BR7HS	4122			BR7HIX	7067	0.6
	Ark (Liquid Cooled)	97→	BR8HS	4322			BR8HIX	7001	0.7
	Eikon 50	99→	BR8HS	4322			BR8HIX	7001	0.7
	Enduro 50		BR10ES	4832			BR10EIX	6801	0.7
	Mini Cross 10/10, 12/13, 12/15 & Mini Trial	05→07	B7HS	5110			BR7HIX	7067	0.6
	Quadra	97→	BR7HS	4122			BR7HIX	7067	0.6
	R10 (12.7mm Thread Reach)	08→09	B7HS	5110			BR7HIX	7067	0.6
	R12 (12.7mm Thread Reach)	08→09	B7HS	5110			BR7HIX	7067	0.6
	R10, R12 (19mm Thread Reach)	10→12	BR8ES	5422			BR8EIX	5044	0.6
	Rev 50	03→	B9ES	2611			BR9EIX	3981	0.5
	RR Enduro 50	98→05	BR10ES	4832			BR10EIX	6801	0.7
	RR Enduro 50, Racing 50 (Euro 2)	04→	BR9ES	5722			BR9EIX	3981	0.6
	RR 50 Motard	08→	BR9ES	5722			BR9EIX	3981	0.6
	Supermotard 50	02→05	BR10ES	4832			BR10EIX	6801	0.7
	Supermoto 50		BR10ES	4832			BR10EIX	6801	0.7
Tempo		BR7HS	4122			BR7HIX	7067	0.6	
Zero		B8ES	2411			BR8EIX	5044	0.5	
70	Supermoto 72, Enduro 72						BR10HIX	6692	0.6
80	EVO 80, Junior	09→	BR8ES	5422			BR8EIX	5044	0.6
	Rev 80	03→	B9ES	2611			BR9EIX	3981	0.5
107	R107-4T		C7HSA	4629			CR7HIX	7544	0.7
125	125 E6G		B7HS	5110			BR7HIX	7067	0.5
	125 Enduro		B7HS	5110			BR7HIX	7067	0.5
	125 Trial		B6ES	7310					0.5
	Alp 4T 125	00→	DR8EA	7162	DR8EVX	6354	DR8EIX	6681	0.6
	Eikon 125	99→	DPR7EA-9	5129			DPR7EIX-9	7803	0.9
	Euro 125		DR8EA	7162	DR8EVX	6354	DR8EIX	6681	0.6
	EVO 125 2T	09→16	BR7ES	5122			BR7EIX	6664	0.6
	EVO 125 2T	17→					GR7CI-8	95476	0.8
	Minicross R 125 4T	08→	C7HSA	4629			CR7HIX	7544	0.7
	RE 125 4T	08→09	CR7HSA	4549			CR7HIX	7544	0.6
	REV 3 125 Trials	00→07	BP7ES	2412			BPR7EIX	4055	0.6
	REV 3 125 Trials	08→	BR7ES	5122			BR7EIX	6664	0.7
	RR 125 4-Stroke Enduro, Motard (Air Cooled)	08→11	CR7HSA	4549			CR7HIX	7544	0.6
	RR 125 4-Stroke Enduro, Motard (Liquid Cooled)	10→	CR8E	1275			CR8EIX	4218	0.6
	Synt	92→	B8ES	2411			BR8EIX	5044	0.5
	TR32	85→	B8ES	2411			BR8EIX	5044	0.5
	TR34	87→	B8ES	2411			BR8EIX	5044	0.5
TR35	90→	B8ES	2411			BR8EIX	5044	0.5	
Urban 125	08→	CR7HSA	4549			CR7HIX	7544	0.6	
Zero	92→	B8ES	2411			BR8EIX	5044	0.5	
150	Eikon 150	99→	DPR7EA-9	5129			DPR7EIX-9	7803	0.9
200	Alp 4T 200	00→	DR8EA	7162	DR8EVX	6354	DR8EIX	6681	0.6
	EVO 200 2T	09→16	BR7ES	5122			BR7EIX	6664	0.6
	EVO 200 2T	17→					GR7CI-8	95476	0.8



CC	MODEL	DATE	STANDARD COPPER CORE	STOCK NUMBER	PLATINUM OR GOLD PALLADIUM	STOCK NUMBER	IRIDIUM	STOCK NUMBER	GAP MM
BETA / BETAMOTOR (CONTINUED)									
200	REV 3 200 Trials	00→07	BP7ES	2412			BPR7EIX	4055	0.6
	REV 3 200 Trials	08→	BR7ES	5122			BR7EIX	6664	0.7
	Techno 200 Trial	→96	BR8ES	5422			BR8EIX	5044	0.6
	Techno 200 Trial	96→	BP7ES	2412			BPR7EIX	4055	0.6
	Urban 200	08→	DR8EA	7162	DR8EVX	6354	DR8EIX	6681	0.6
240	Super Trial	92→93	B8ES	2411			BR8EIX	5044	0.5
	TR33	86→	B6ES	7310					0.5
	Trial	85→	B6ES	7310					0.5
250	EVO 250 2T	09→16	BR7ES	5122			BR7EIX	6664	0.6
	EVO 250 2T	17→					GR7CI-8	95476	0.8
	EVO 250 4T	09→17	CR7EB	4663			CR7EIX	7385	0.6
	GS Enduro	77→	B7HS	5110			BR7HIX	7067	0.5
	REV 3 250 2T Trials	00→07	BP7ES	2412			BPR7EIX	4055	0.6
	REV 3 250 2T Trials	08→	BR7ES	5122			BR7EIX	6664	0.7
	REV 4T 250 Trials	07→17	CR7EB	4663			CR7EIX	7385	0.6
	RR 250 2-stroke	13→15	BR7ES	5122			BR7EIX	6664	0.6
	RR 250 2-stroke	16→	BR8ES	5422			BR8EIX	5044	0.6
	RR 250 4T	05→06	DCPR8E*	4339			DCPR8EIX	6546	0.7
	Techno 250 Trial	→96	BR8ES	5422			BR8EIX	5044	0.6
	Techno 250 Trial	96→	BP7ES	2412			BPR7EIX	4055	0.6
	TR32	85→	B8ES	2411			BR8EIX	5044	0.5
260	Synt	92→	B8ES	2411			BR8EIX	5044	0.5
	TR34	87→	B8ES	2411			BR8EIX	5044	0.5
	TR35	90→	B8ES	2411			BR8EIX	5044	0.5
	Zero Gara	93→	B8ES	2411			BR8EIX	5044	0.5
270	REV 3 270 Trials	00→07	BP7ES	2412			BPR7EIX	4055	0.6
	REV 3 270 Trials	08→	BR7ES	5122			BR7EIX	6664	0.7
	Techno 270 Trial	→96	BR8ES	5422			BR8EIX	5044	0.6
	Techno 270 Trial	96→	BP7ES	2412			BPR7EIX	4055	0.6
290	EVO 290 2T	09→	BR7ES	5122			BR7EIX	6664	0.6
300	Xtrainer	15→					GR7CI-8	95476	0.8
	EVO 300 2T	11→16	BR7ES	5122			BR7EIX	6664	0.6
	EVO 300 2T	17→					GR7CI-8	95476	0.8
	EVO 300 4T	09→17	CR7EB	4663			CR7EIX	7385	0.6
	EVO 300 4T	18→					MR7BI-8	90982	0.8
	RR 300 2-stroke	13→	BR7ES	5122			BR7EIX	6664	0.6
350	Alp 4.0 (Suzuki engine)	08→	CR9EK	4548			CR9EIX	3521	0.7
	Euro 350	01→	CR9EK	4548			CR9EIX	3521	0.7
	Jonathan 350	99→06	CR9EK	4548			CR9EIX	3521	0.7
	Motard 4.0, M4	08→14	CR9EK	4548			CR9EIX	3521	0.7
	RR 350	11→	LKAR8A-9	4786			LKAR8AI-9	6706	0.9
386	RR 390	15→	LKAR8A-9	4786			LKAR8AI-9	6706	0.9
	RS 390	15→	LKAR8A-9	4786			LKAR8AI-9	6706	0.9
400	RR 400 4T	05→09	DCPR8E*	4339			DCPR8EIX	6546	0.7
	RR 400 4-stroke	10→	LKAR8A-9	4786			LKAR8AI-9	6706	0.9
	RS 400	11→14	LKAR8A-9	4786			LKAR8AI-9	6706	0.9
430	RR 430	15→	LKAR8A-9	4786			LKAR8AI-9	6706	0.9
	RS 430	15→	LKAR8A-9	4786			LKAR8AI-9	6706	0.9
450	RR 450 4T	05→09	DCPR8E*	4339			DCPR8EIX	6546	0.7
	RR 450 4-stroke	10→14	LKAR8A-9	4786			LKAR8AI-9	6706	0.9
	RS 450	11→14	LKAR8A-9	4786			LKAR8AI-9	6706	0.9
480	RR 480	15→	LKAR8A-9	4786			LKAR8AI-9	6706	0.9
500	RR 500	13→14	LKAR8A-9	4786			LKAR8AI-9	6706	0.9
	RS 500	15→	LKAR8A-9	4786			LKAR8AI-9	6706	0.9
	RR 520 4-stroke	10→14	LKAR8A-9	4786			LKAR8AI-9	6706	0.9
	RS 520	11→14	LKAR8A-9	4786			LKAR8AI-9	6706	0.9
525	RR 525 4T	05→09	DCPR8E*	4339			DCPR8EIX	6546	0.7



* Please note DCPR8E 4339 has a removable terminal nut, whereas DCPR8E 4179 has a fixed terminal nut





CC	MODEL	DATE	STANDARD COPPER CORE	STOCK NUMBER	PLATINUM OR GOLD PALLADIUM	STOCK NUMBER	IRIDIUM	STOCK NUMBER	GAP MM
BIMOTA									
500	500 V-Due		BR9ES	5722			BR9EIX	3981	0.7
600	YB9 SRi		CR9E	6263			CR9EIX	3521	0.7
900	DB3 Mantra		DPR8EA-9	4929			DPR8EIX-9	2202	0.6
	DB4		DPR8EA-9	4929			DPR8EIX-9	2202	0.6
	Mantra		DPR7EA-9	5129			DPR7EIX-9	7803	0.9
992	DB5	05→	DCPR8E*	4339			DCPR8EIX	6546	0.9
	DB6 Delirio	06→	DCPR8E*	4339			DCPR8EIX	6546	0.9
1000	BB3	08/14→16	LMAR9D-J	1633					0.8
	Mono, Biposto	91→93	D8EA	2120	DR8EVX	6354	DR8EIX	6681	0.6
	SB8R/S	99→00	CR9EK	4548			CR9EIX	3521	0.7
	YB11 Superleggera	00→	DR8EA	7162	DR8EVX	6354	DR8EIX	6681	0.7
1078	DB5R/S	07→	DCPR8E*	4339			DCPR8EIX	6546	0.9
	DB6R/S	08→	DCPR8E*	4339			DCPR8EIX	6546	0.9
	DB10 bimotard	12→16	DCPR8E*	4339			DCPR8EIX	6546	0.9
	DBx	13→16	DCPR8E*	4339			DCPR8EIX	6546	0.9
	Tesi 3D	07→16	DCPR8E*	4339			DCPR8EIX	6546	0.9
1098	DB7	09→	MAR10A-J	4706					0.8
1100	SB6, SB6R	97→	CR9E	6263			CR9EIX	3521	0.7
1198	DB8	10→16	MAR10A-J	4706					0.8
	DB9 Brivido, S	12→16	MAR9A-J	6869					0.8

BMW									
125	C1	00→04	CR8EB	7784			CR8EIX	4218	0.7
175	C1 200	01→04	CR8EB	7784			CR8EIX	4218	0.7
313	G310 GS	18→	LMAR9D-J	1633					0.8
	G310 R	17→	LMAR9D-J	1633					0.8
350	C 400 GT	19→	LMAR8J-9E	93972					0.9
	C 400 X	18→	LMAR8J-9E	93972					0.9
450	G450X	08→11	CR9EKB	2305			CR9EIX	3521	0.8
	R45	78→85	BP7ES	2412			BPR7EIX	4055	0.6
600	R60/7	76→78	BP7ES	2412			BPR7EIX	4055	0.6
650	C600 Sport	12→15	LMAR8D-J	93444					0.8
	C650 GT	12→	LMAR8D-J	93444					0.8
	C650 Sport	16→	LMAR8D-J	93444					0.8
	F650	94→99	D8EA	2120	DR8EVX	6354	DR8EIX	6681	0.7
	F650ST Strada	97→99	D8EA	2120	DR8EVX	6354	DR8EIX	6681	0.7
	F650GS, GSD	00→02	DR8EB	4855	DR8EVX	6354	DR8EIX	6681	0.7
	F650CS, GS, GS Dakar	02→05	DR8EB	4855	DR8EVX	6354	DR8EIX	6681	0.7
	F650GS, GS Dakar (Single cylinder Twin Spark)	11/05→11/07	DR8EB	4855	DR8EVX	6354	DR8EIX	6681	0.7
	G650GS (Twin Spark)	03/11→	DR8EB	4855	DR8EVX	6354	DR8EIX	6681	0.7
	G650GS Sertão (Twin Spark)	03/12→	DR8EB	4855	DR8EVX	6354	DR8EIX	6681	0.7
	G650 Xchallenge, Xcountry, Xmoto (Twin Spark)	07→09	DR8EB	4855	DR8EVX	6354	DR8EIX	6681	0.7
	R65	78→93	BP7ES	2412			BPR7EIX	4055	0.6
	R65/GS	87→92	BP6ES	7811			BPR6EIX	6637	0.6
	R65LS	81→85	BP7ES	2412			BPR7EIX	4055	0.6
	750	K75 (Plug requires terminal nut)	85→97	D7EA	7912				
R75/7		76→79	BP7ES	2412			BPR7EIX	4055	0.6
800	F650GS (Twin cylinder 798cc)	11/07→12	DCPR8E*	4339			DCPR8EIX	6546	0.7
	F 700 GS	13→17	DCPR8E*	4339			DCPR8EIX	6546	0.8
	F800S/ST	05/06→12	DCPR8E*	4339			DCPR8EIX	6546	0.8
	F 800 GT	13→	DCPR8E*	4339			DCPR8EIX	6546	0.8
	F800GS	11/07→17	DCPR8E*	4339			DCPR8EIX	6546	0.8
	F800R	05/09→19	DCPR8E*	4339			DCPR8EIX	6546	0.8
	R80GS	80→94	BP6ES	7811			BPR6EIX	6637	0.6
	R80RT	82→95	BP6ES	7811			BPR6EIX	6637	0.6
	R80ST	82→85	BP6ES	7811			BPR6EIX	6637	0.6
	R80TIC	80→85	BP6ES	7811			BPR6EIX	6637	0.6
850	F 750 GS	18→	LMAR8J-9E	93972					0.9
	F 850 GS	18→	LMAR8J-9E	93972					0.9
	R850C, R850GS, R850R	10/96→00	BKR7EKC	7354			BKR7EIX	2667	0.8
	R850RT	10/96→02/06	BKR7EKC	7354			BKR7EIX	2667	0.8



* Please note DCPR8E 4339 has a removable terminal nut, whereas DCPR8E 4179 has a fixed terminal nut





CC	MODEL	DATE	STANDARD COPPER CORE	STOCK NUMBER	PLATINUM OR GOLD PALLADIUM	STOCK NUMBER	IRIDIUM	STOCK NUMBER	GAP MM
BMW (CONTINUED)									
900	R90/6	73→76	BP6ES	7811			BPR6EIX	6637	0.6
	R90S	73→76	BP6ES	7811			BPR6EIX	6637	0.6
1000	K1 (Plug requires terminal nut)	89→93	D7EA	7912					0.6
	K100, C, LT, R, RS, RT 8 Valve (Plug requires terminal nut)	83→90	D7EA	7912					0.6
	K100, C, LT, R, RS, RT 16 Valve (Plug requires terminal nut)	91→92	D7EA	7912					0.6
	R100/7	76→79	BP7ES	2412			BPR7EIX	4055	0.6
	R100RS, S	76→85	BP7ES	2412			BPR7EIX	4055	0.6
	R100RT	79→85	BP7ES	2412			BPR7EIX	4055	0.6
	R100GS, RS, RT (Re-introduced)	87→93	BP6ES	7811			BPR6EIX	6637	0.6
	S1000R	11/13→	LMAR9D-J	1633					0.8
	S1000RR (Incl. HP4)	12/09→18	LMAR9D-J	1633					0.8
	S1000RR	19→					LMAR9FI-10G	92850	1.0
S1000 XR	06/15→19	LMAR9D-J	1633					0.8	
1100	K1100LT/SE	92→99	DR7EA	7839					0.6
	K1100RS	92→96	DR7EA	7839					0.6
	R1100GS	04/93→99	BKR7EKC	7354			BKR7EIX	2667	0.8
	R1100R	95→03	BKR7EKC	7354			BKR7EIX	2667	0.8
	R1100RS/RT	93→01	BKR7EKC	7354			BKR7EIX	2667	0.8
	R1100S	12/96→03	BKR7EKC	7354			BKR7EIX	2667	0.8
	R1100S (Twin Spark)	Ø12mm Plug Ø14mm Plug	03→05	DCPR8EKC BKR7EKC	7168 7354		DCPR8EIX BKR7EIX	6546 2667	0.9 0.9
1130	R1150GS/R/RS/RT	99→03	BKR7EKC	7354			BKR7EIX	2667	0.9
	R1150GS/R/S (Twin Spark)	Ø12mm Plug Ø14mm Plug	03→05	DCPR8EKC BKR7EKC	7168 7354		DCPR8EIX BKR7EIX	6546 2667	0.9 0.9
1157	K1200R	01/05→08					KR9CI	7795	0.8
	K1200R Sport	11/07→09					KR9CI	7795	0.8
	K1200S	09/04→09					KR9CI	7795	0.8
1170	HP2 Enduro (Twin Spark)	Ø12mm Plug Ø14mm Plug	05→08	DCPR8EKC BKR7EKC	7168 7354		DCPR8EIX BKR7EIX	6546 2667	0.9 0.9
	HP2 Megamoto (Twin Spark) Ø12mm Plug		07→08	DCPR8EKC	7168		DCPR8EIX	6546	0.9
	HP2 Sport		08→12	MAR9B-JDS	1316				0.8
	K1200GT		03→11/05	DCPR7E	3932		DCPR7EIX	6046	0.8
	K1200GT		01/06→08				KR9CI	7795	0.8
	K1200RS/LT		97→05	DCPR7E	3932		DCPR7EIX	6046	0.8
	R1200C Classic, Avantgarde, Independent		97→04	BKR7EKC	7354		BKR7EIX	2667	0.9
	R1200GS (Twin Spark) Ø12mm Plug		04→09	DCPR8EKC	7168		DCPR8EIX	6546	0.9
	R1200GS (Twin Spark) Ø10mm Plug (19mm Thread Reach)		10→02/13	MAR8B-JDS	8765				0.8
	R1200GS (Liquid Cooled) (26.5mm Thread Reach)		03/13→17	LMAR8D-J	93444				0.8
	R1200GS Adventure (Liquid Cooled) (26.5mm Thread Reach)		10/13→17	LMAR8D-J	93444				0.8
	R1200R SOHC (Twin Spark) Ø12mm Plug		06→10	DCPR8EKC	7168		DCPR8EIX	6546	0.9
	R1200R, Classic DOHC (Twin Spark) Ø10mm Plug (19mm Thread Reach)		03/11→14	MAR8B-JDS	8765				0.8
	R1200 R (26.5mm Thread Reach)		02/15→18	LMAR8D-J	93444				0.8
	R1200 RS (26.5mm Thread Reach)		06/15→18	LMAR8D-J	93444				0.8
	R1200RT (Twin Spark) Ø12mm Plug		03/05→09	DCPR8EKC	7168		DCPR8EIX	6546	0.9
	R1200RT (Twin Spark) Ø10mm Plug (19mm Thread Reach)		09→10/13	MAR8B-JDS	8765				0.8
	R1200RT (Liquid Cooled) (26.5mm Thread Reach)		11/13→17	LMAR8D-J	93444				0.8
	R1200S (Twin Spark)		06→07	DCPR8EKC	7168		DCPR8EIX	6546	0.9
	R1200ST (Twin Spark)		03/05→11/07	DCPR8EKC	7168		DCPR8EIX	6546	0.9
	R nineT (Twin Spark)		14→	MAR8B-JDS	8765				0.8
	R nineT Pure, Racer (Twin Spark)		16→	MAR8B-JDS	8765				0.8
R nineT Scrambler (Twin Spark)		16→	MAR8B-JDS	8765				0.8	
R nineT Urban (Twin Spark)		16→	MAR8B-JDS	8765				0.8	
1254	R1200GS Adventure	2018					LMAR8AI-10	94319	1.0
	R1200RT	2018					LMAR8AI-10	94319	1.0
	R1250 GS, GS Adventure	19→					LMAR8AI-10	94319	1.0
	R1250 R	19→					LMAR8AI-10	94319	1.0
	R1250 RS	19→					LMAR8AI-10	94319	1.0
	R1250 RT	19→					LMAR8AI-10	94319	1.0
1293	K1300GT (Incl. Exclusive Edition)	09→13					KR9CI	7795	0.8
	K1300R	09→15					KR9CI	7795	0.8
	K1300S (Incl. HP)	09→16					KR9CI	7795	0.8
1640	K1600GT, GTL	11→					LMAR8AI-8	92288	0.8



CC	MODEL	DATE	STANDARD COPPER CORE	STOCK NUMBER	PLATINUM OR GOLD PALLADIUM	STOCK NUMBER	IRIDIUM	STOCK NUMBER	GAP MM
BSA									
50	Beaver, Brigand, Boxer		B6HS	4510			BR6HIX	3419	0.5
	ER1K, Junior, Easy Rider ER1/ER2	80→	BP6ES	7811			BPR6EIX	6637	0.5
	NVT Models: Easy Rider ER1/2/4, Ranger	80→	BP6ES	7811			BPR6EIX	6637	0.5
125	Rambler 125, Tracker 125	79→	B9ES	2611			BR9EIX	3981	0.5
175	Rambler 175, Tracker 175, Trials 175	79→	B8ES	2411			BR8EIX	5044	0.5
400	Gold SR 400	99→03	BPR6ES	7822			BPR6EIX	6637	0.7
500	Gold SR 500	99→	BPR7ES	2023			BPR7EIX	4055	0.7
	Victor, B50 Moto-Cross	66→67	B8EG	3430			BR8EIX	5044	0.5
650	Golden Flash (A10) (1/2", 12.7mm Thread Reach)	50→54	B6HS	4510			BR6HIX	3419	0.5
	Road Rocket (3/4", 19mm Thread Reach)	54→56	B7ES	1111			BR7EIX	6664	0.5
	Rocket Gold Star	62→63	B7ES	1111			BR7EIX	6664	0.5
	Super Rocket	57→62	B7ES	1111			BR7EIX	6664	0.5
750	A75 and Rocket 3	→75	B8ES	2411			BR8EIX	5044	0.6

BUELL									
984	Firebolt XB9R	02→	DCPR9E	2641			DCPR9EIX	2316	0.9
	Lightning CityX XB9SX	05→	DCPR9E	2641			DCPR9EIX	2316	0.9
	Lightning XB9S	02→	DCPR9E	2641			DCPR9EIX	2316	0.9
	XB9X (City X)	09→10	DCPR9E	2641			DCPR9EIX	2316	0.9
1125	1125R	08→10	CR9EKB	2305			CR9EIX	3521	0.8
	1125CR (Café Racer)	09→10	CR9EKB	2305			CR9EIX	3521	0.8
1200	Firebolt XB12R	03→	DCPR9E	2641			DCPR9EIX	2316	0.9
	Lightning XB12S/Ss	04→10	DCPR9E	2641			DCPR9EIX	2316	0.9
	Lightning XB12Scg	06→10	DCPR9E	2641			DCPR9EIX	2316	0.9
	Lightning XB12STT	07→10	DCPR9E	2641			DCPR9EIX	2316	0.9
	M2 Cyclone	97→03	DCPR9E	2641			DCPR9EIX	2316	0.9
	S1 Lightning	97→99	DCPR9E	2641			DCPR9EIX	2316	0.9
	S1W White Lightning	1998	DCPR9E	2641			DCPR9EIX	2316	0.9
	S3 Thunderbolt	97→99	DCPR9E	2641			DCPR9EIX	2316	0.9
	Ulysses XB12X	05→	DCPR9E	2641			DCPR9EIX	2316	0.9
	X1 Lightning	99→03	DCPR9E	2641			DCPR9EIX	2316	0.9

CAGIVA									
50	City 50	94→	BPR8HS	3725			BPR8HIX	6742	0.5
	Mito 50 (Standard)	98→	B9ES	2611			BR9EIX	3981	0.5
	Prima 50	92→	B8ES	2411			BR8EIX	5044	0.5
	Supercity 50	92→	B8ES	2411			BR8EIX	5044	0.5
	W4 50	92→	B8ES	2411			BR8EIX	5044	0.5
75	Prima 80	92→	B8ES	2411			BR8EIX	5044	0.5
	Supercity 80	92→	B8ES	2411			BR8EIX	5044	0.5
	W4 80	92→	B8ES	2411			BR8EIX	5044	0.5
125	Blues 125	91→93					BR10EIX	6801	0.5
	Freccia C12/C12R	89→	B9ES	2611			BR9EIX	3981	0.5
	K7	90→					BR10EIX	6801	0.5
	Mito 125	91→	BR9EG	3230			BR9EIX	3981	0.6
	Mito 125 (Race)						BR10EIX	6801	0.7
	Mito (Le Lawson)	92→					BR10EIX	6801	0.5
	Mito 525SP	04/08→	BR9EG	3230			BR9EIX	3981	0.6
	Planet 125	98→					BR10EIX	6801	0.6
	Raptor (2-Stroke)	04→	BR9EG	3230			BR9EIX	3981	0.6
	Roadster 125	92→	B9ES	2611			BR9EIX	3981	0.6
	Super City 125	→02/95	B9EG	3530			BR9EIX	3981	0.5
	Super City 125	06/98→					BR10EIX	6801	0.6
	W8 125	→12/92	B9EG	3530			BR9EIX	3981	0.6
	W8 125	07/98→	B9ES	2611			BR9EIX	3981	0.6
	WMX 125		B10EG	3630			BR10EIX	6801	0.5
WSXT 125	82→	B9EG	3530			BR9EIX	3981	0.5	
250	SST 250	81→	B8ES	2411			BR8EIX	5044	0.5
	WMX 250						BR10EIX	6801	0.5
350	Indiana 350	78→89	BP7HS	5111			BPR7HIX	5944	0.5
	W12 350	93→	DPR8EA-9	4929			DPR8EIX-9	2202	0.6



CC	MODEL	DATE	STANDARD COPPER CORE	STOCK NUMBER	PLATINUM OR GOLD PALLADIUM	STOCK NUMBER	IRIDIUM	STOCK NUMBER	GAP MM
CAGIVA (CONTINUED)									
500	Canyon 500	02/98→	DCPR8E*	4179			DCPR8EIX	6546	0.6
	River 500	99→	DCPR8E*	4179			DCPR8EIX	6546	0.6
600	Canyon 600	→03/97	BCP7ES	5030			BCPR7EIX	5690	0.8
	River 600	95→	BCP7ES	5030			BCPR7EIX	5690	0.8
	W16 600	→95	C7E	5096			CR7EIX	7385	0.6
	W16 600	95→	BCP7ES	5030			BCPR7EIX	5690	0.8
650	Alazzurra 650	85→88	BP7HS	5111			BPR7HIX	5944	0.5
	Indiana 650		BP7HS	5111			BPR7HIX	5944	0.5
	Raptor	00→	CR8E	1275			CR8EIX	4218	0.7
	V Raptor	00→	CR8E	1275			CR8EIX	4218	0.7
750	Elefant 750	87→	DPR8EA-9	4929			DPR8EIX-9	2202	0.6
	Indiana 750		BP7HS	5111			BPR7HIX	5944	0.5
900	900GT	91→	DR9EA	3437			DR9EIX	4772	0.5
	900 i.e.	91→	DR9EA	3437			DR9EIX	4772	0.5
	Elefant 900	91→	DPR8EA-9	4929			DPR8EIX-9	2202	0.9
	Gran Canyon	99→	DCPR8E*	4179			DCPR8EIX	6546	0.6
1000	Navigator/T	00→	CR8EK	3478			CR8EIX	4218	0.7
	Raptor	00→	CR8EK	3478			CR8EIX	4218	0.7
	V Raptor	00→	CR8EK	3478			CR8EIX	4218	0.7
	Xtra Raptor	02→	CR8EK	3478			CR8EIX	4218	0.7

CAN-AM (BRP)									
998	Spyder RS	08→12	DCPR9E	2641			DCPR9EIX	2316	0.7
	Spyder RS Ø12mm Plug	13→					KR8BI	4347	0.7
	Spyder RT Ø12mm Plug	10→11	DCPR9E	2641			DCPR9EIX	2316	0.7
	Spyder RT Ø12mm Plug	12→13					KR8BI	4347	0.7
	Spyder ST Ø12mm Plug	13→					KR8BI	4347	0.7
1330	Spyder RT Ø10mm Plug	14→					MR7BI-8	90982	0.8
	Spyder F3	15→					MR7BI-8	90982	0.8

CCM (ARMSTRONG-CCM)									
125	CMX 125 L/C	83→85	B9EG	3530			BR9EIX	3981	0.5
	Moto-X Hiro 125	79→80	B10EG	3630			BR10EIX	6801	0.5
240	Trials CMT 240		BP5ES	6511			BPR5EIX	6597	0.5
250	CMT 250 Trials		BP5ES	6511			BPR5EIX	6597	0.5
	CMX 250 1982	1982	B8EG	3430			BR8EIX	5044	0.5
	CMX 250, 250 L/C	83→85	B9EG	3530			BR9EIX	3981	0.5
	Moto-X Hiro 250	79→81	B9EG	3530			BR9EIX	3981	0.5
310	CMT 310 Trials		BP5ES	6511			BPR5EIX	6597	0.5
320	CMT 320 Trials		BP5ES	6511			BPR5EIX	6597	0.5
350	350 Trials	1978	B6ES	7310					0.5
	CMT 350 Trials		BP5ES	6511			BPR5EIX	6597	0.5
400	404E/DS	03→	CR8E	1275			CR8EIX	4218	0.7
	404XC-Trail		CR8E	1275			CR8EIX	4218	0.7
	FT35	05→	CR8E	1275			CR8EIX	4218	0.7
	R35	06→	CR8E	1275			CR8EIX	4218	0.7
	SR40	07→	CR8E	1275			CR8EIX	4218	0.7
434	R35 Factory Big Bore Conversion	06→	CR8E	1275			CR8EIX	4218	0.7
450	CMX 450	82→	B8EG	3430			BR8EIX	5044	0.5
490	CMX 490		B8EG	3430			BR8EIX	5044	0.5
500	CMX 500 (4-Stroke)		D8EA	2120	DR8EVX	6354	DR8EIX	6681	0.5
	Moto-X (4-Stroke) 2 valve models	72→79	B8EG	3430			BR8EIX	5044	0.5
	Moto-X (4-Stroke) 4 valve models	79→81					CR8EIX	4218	0.5
	MTT 500		D8EA	2120	DR8EVX	6354	DR8EIX	6681	0.5
560	CCM 560		D8EA	2120	DR8EVX	6354	DR8EIX	6681	0.5
	CMX 560 (4-Stroke)		D8EA	2120	DR8EVX	6354	DR8EIX	6681	0.5
600	604E Sport & Supermoto	98→02	D8EA	2120	DR8EVX	6354	DR8EIX	6681	0.5
	604R / RS / R30	98→02	D8EA	2120	DR8EVX	6354	DR8EIX	6681	0.5
640	640 RS (Rotax engine)	99→00	D8EA	2120	DR8EVX	6354	DR8EIX	6681	0.5



* Please note DCPR8E 4339 has a removable terminal nut, whereas DCPR8E 4179 has a fixed terminal nut





CC	MODEL	DATE	STANDARD COPPER CORE	STOCK NUMBER	PLATINUM OR GOLD PALLADIUM	STOCK NUMBER	IRIDIUM	STOCK NUMBER	GAP MM
CCM (ARMSTRONG-CCM) (CONTINUED)									
644	644 (Suzuki engine)	02→07	CR10E	6264			CR10EIX	6482	0.7
	R30 (Suzuki engine)	05→07	CR10E	6264			CR10EIX	6482	0.7
710	R30 (Suzuki engine)	05→07	CR10E	6264			CR10EIX	6482	0.7

CF MOTO									
250	V3 Auto 250T-3	07→	DPR8EA-9	4929			DPR8EIX-9	2202	0.9
	V5 Auto 250T-5		DPR8EA-9	4929			DPR8EIX-9	2202	0.9

COSSACK									
350	Jupiter	73→79	BR6HS	3922			BR6HIX	3419	0.6
	Planeta	73→79	BR6HS	3922			BR6HIX	3419	0.6
650	Dnepr, Ural	73→79	BR6HS	3922			BR6HIX	3419	0.6

CPI									
50	Aragon 50	06→	BR7ES	5122			BR7EIX	6664	0.7
	Aragon GP50	06→	BR7ES	5122			BR7EIX	6664	0.7
	Formula R (Euro 1, 12.7mm Thread Reach)	→05	BR7HS	4122			BR7HIX	7067	0.7
	Formula R (Euro 2, 19mm Thread Reach)	06→	BR7ES	5122			BR7EIX	6664	0.7
	GTR 50 (12.7mm Thread Reach)	03→04	BR7HS	4122			BR7HIX	7067	0.7
	GTR 50 (19mm Thread Reach)	05→	BR10EG	3830			BR10EIX	6801	0.6
	GTS 50 (12.7mm Thread Reach)	03→04	BR7HS	4122			BR7HIX	7067	0.7
	GTS 50 (19mm Thread Reach)	05→	BR10EG	3830			BR10EIX	6801	0.6
	Hussar 50, Mars JP50, Baby J 50 (Euro 1)		BR8HSA	5539			BPR8HIX	6742	0.6
	Hussar 50 (Euro 2)	03→	BR7ES	5122			BR7EIX	6664	0.7
	Oliver 50 (Euro 2)	03→	BR7ES	5122			BR7EIX	6664	0.7
	Popcorn 50 (Euro 2)	03→	BR7ES	5122			BR7EIX	6664	0.7
	Supercross 50 (Euro 1, 12.7mm Thread Reach)		BR7HS	4122			BR7HIX	7067	0.7
	Supercross 50 (Euro 2, 19mm Thread Reach)	03→05	BR7ES	5122			BR7EIX	6664	0.7
	Supercross 50 SX	06→07	BR7ES	5122			BR7EIX	6664	0.7
	Supermoto 50 (Euro 1, 12.7mm Thread Reach)		BR7HS	4122			BR7HIX	7067	0.7
	Supermoto 50 (Euro 2, 19mm Thread Reach)	03→	BR7ES	5122			BR7EIX	6664	0.7
	125	GTS 125	02→03	BR7HS	4122			BR7HIX	7067
Hussar JU 125		04→	CR7HSA	4549			CR7HIX	7544	0.6
Oliver City 125		06→	CR7HSA	4549			CR7HIX	7544	0.6
QT4A ARN 125			CR7HSA	4549			CR7HIX	7544	0.6
X-Large 125			BR7HS	4122			BR7HIX	7067	0.7
150	GTS 150		BR7HS	4122			BR7HIX	7067	0.7
	X-Large 150		BR7HS	4122			BR7HIX	7067	0.7
200	GTS 200		BR7HS	4122			BR7HIX	7067	0.7
	X-Large 200		BR7HS	4122			BR7HIX	7067	0.7

CZ (SEE JAWA-CZ)

DAELIM									
50	Cordi	04→	BPR6HS	7022			BPR6HIX	4085	0.6
	E Five	03→	B8HS	5510			BR8HIX	7001	0.7
	Message 49	98→	BR8HSA	5539			BPR8HIX	6742	0.7
	S Five	02→	B8HS	5510			BR8HIX	7001	0.7
100	Delfino 100	99→	BR8HS	4322			BR8HIX	7001	0.7
110	Citi Ace 110	03→	C7HSA	4629			CR7HIX	7544	0.7
125	Altino NF125ES	03→	CR8EH-9	5666			CR8EHIX-9	3797	0.9
	History 125	04→	CR8EH-9	5666			CR8EHIX-9	3797	0.9
	NS125 Trans Eagle	98→	CR8EH-9	5666			CR8EHIX-9	3797	0.9
	Roadwin (Incl. R)	04→	CR8EH-9	5666			CR8EHIX-9	3797	0.9
	VEE125		CR8EH-9	5666			CR8EHIX-9	3797	0.9
	VL125 Daystar		CR8EH-9	5666			CR8EHIX-9	3797	0.9
	VS125	97→	CR8EH-9	5666			CR8EHIX-9	3797	0.9



CC	MODEL	DATE	STANDARD COPPER CORE	STOCK NUMBER	PLATINUM OR GOLD PALLADIUM	STOCK NUMBER	IRIDIUM	STOCK NUMBER	GAP MM
DAELIM (CONTINUED)									
250	Roadsport	12→	CR9EH-9	7502			CR9EHIX-9	6216	0.9
	VJF250 (Roadwin)	12→	CR9EH-9	7502			CR9EHIX-9	6216	0.9

DERBI									
50	Atlantis 50 (4-Stroke)	04→	CR8EB	7784			CR8EIX	4218	0.7
	Atlantis 50 (Air Cooled, 12.7mm Thread Reach)	99→02	B8HS	5510			BR8HIX	7001	0.5
	Atlantis 50 (Air Cooled, 19mm Thread Reach)	03→	BR9ES	5722			BR9EIX	3981	0.6
	Atlantis 50 (Liquid Cooled)	00→	BR9ES	5722			BR9EIX	3981	0.6
	Black Devil	03→	B8ES	2411			BR8EIX	5044	0.6
	Black Edition	03→	B8ES	2411			BR8EIX	5044	0.6
	Black Mini	03→	CR9E	6263			CR9EIX	3521	0.6
	Dirt Boy, Dirt Kid	03→	CR9E	6263			CR9EIX	3521	0.6
	DRD 50 Supermoto	02→	B8ES	2411			BR8EIX	5044	0.5
	GP1	03→	BR10ES	4832			BR10EIX	6801	0.7
	GPR 50-R	97→	B8ES	2411			BR8EIX	5044	0.5
	GPR 50 (Standard power)	02→09	B8ES	2411			BR8EIX	5044	0.5
	GPR 50 (Full power)	02→	B9ES	2611			BR9EIX	3981	0.6
	GPR 50	10→	BR8ES	5422			BR8EIX	5044	0.6
	Hunter	96→98	B8HS	5510			BR8HIX	7001	0.5
	Predator LC	98→	B8ES	2411			BR8EIX	5044	0.5
	Senda 50 / R / SM (Standard power)	95→	B8ES	2411			BR8EIX	5044	0.5
	Senda 50 / R / SM (Full power)	95→	B9ES	2611			BR9EIX	3981	0.6
	Sonar 50 2T	09→	BR8ES	5422			BR8EIX	5044	0.6
Vamos	95→97	B8HS	5510			BR8HIX	7001	0.5	
85	Atlantis 100	00→	BR9ES	5722			BR9EIX	3981	0.7
	Senda 100	97→	B9ES	2611			BR9EIX	3981	0.6
125	Boulevard 125 4T	03→	CPR8E	7411			CR8EIX	4218	0.6
	Cross City 125	07→	D8EA	2120	DR8EVX	6354	DR8EIX	6681	0.8
	GP1 125	06→	CR9EB	6955			CR9EIX	3521	0.6
	GPR 125 (Yamaha engine)	04→09	BR8ES	5422			BR8EIX	5044	0.7
	GPR 125	10→	CR8EB	7784			CR8EIX	4218	0.7
	HDR Cabriolet 125	00→	CR7E	4578			CR7EIX	7385	0.5
	Mulhacén Café 125	07→	CR8EB	7784			CR8EIX	4218	0.7
	Rambla 125	08→	CR8EB	7784			CR8EIX	4218	0.7
	Senda 125 4T (Honda engine)	03→	DPR8EA-9	4929			DPR8EIX-9	2202	0.7
	Senda Baja R 125	07→	D8EA	2120	DR8EVX	6354	DR8EIX	6681	0.8
	Senda DRD 125 4S 4V R	10→	CR8EB	7784			CR8EIX	4218	0.7
	Sonar 125 (4-Stroke)	09→11	CR7EB	4663			CR7EIX	7385	0.6
Terra 125	07→09	CR8EB	7784			CR8EIX	4218	0.7	
150	Boulevard 150 4T	03→	CPR8E	7411			CR8EIX	4218	0.6
250	GP1 250	06→	CR9EB	6955			CR9EIX	3521	0.6
	Rambla 250	08→09	CR9EB	6955			CR9EIX	3521	0.6
300	Rambla 300i	10→	CR8EKB	4374			CR8EIX	4218	0.7
660	Mulhacén 659 / Café	06→	CR7E	4578			CR7EIX	7385	0.5

DUCATI									
250	250 Desmo, Monza, Sebring	71→74	B6HS	4510			BR6HIX	3419	0.5
350	350 Desmo, Sebring	71→74	B6HS	4510			BR6HIX	3419	0.5
	350 Sport	91→	BP7HS	5111			BPR7HIX	5944	0.6
399	Scrambler Sixty2	16→	KR8C-G	97516					0.7
400	400 SS, Junior	91→94	BP7HS	5111			BPR7HIX	5944	0.6
450	450 Desmo, Sebring	71→74	B6HS	4510			BR6HIX	3419	0.5
500	500 Desmo	78→83	B6HS	4510			BR6HIX	3419	0.5
	500 Pantah	80→84	BP7HS	5111			BPR7HIX	5944	0.6
600	600 Monster, Monster S, Monster Dark	94→01	DCPR8E*	4339			DCR8EIX	3606	0.7
	600 Pantah	80→85	BP7HS	5111			BPR7HIX	5944	0.6
	600 SS	→94	DCPR8E*	4339			DCR8EIX	3606	0.7
	600 SS	94→98	DCPR8E*	4339			DCR8EIX	3606	0.7



* Please note DCPR8E 4339 has a removable terminal nut, whereas DCPR8E 4179 has a fixed terminal nut





CC	MODEL	DATE	STANDARD COPPER CORE	STOCK NUMBER	PLATINUM OR GOLD PALLADIUM	STOCK NUMBER	IRIDIUM	STOCK NUMBER	GAP MM
DUCATI (CONTINUED)									
620	620 i.e., S i.e. & i.e. Dark	02→06	DCPR8E*	4339			DCR8EIX	3606	0.7
	Multistrada 620	04→06	DCPR8E*	4339			DCR8EIX	3606	0.7
650	Indiana 650	86→88	BP7HS	5111			BPR7HIX	5944	0.6
695	Monster 695	06→08	DCPR8E*	4339			DCR8EIX	3606	0.7
696	Monster 696	08→14	DCPR8E*	4339			DCR8EIX	3606	0.7
748	748, 748 Biposto	95→04					DCR9EIX	6650	0.6
	Dark	04→06	CR9EB	6955			CR9EIX	3521	0.6
	748 R	00→04	R2349-10	6839					0.6
	748 S	00→04					DCR9EIX	6650	0.6
	748 SP	95→98	R2349-10	6839					0.6
	748 SPS	98→00	R2349-10	6839					0.6
	749 (‡ Socket Ø <20.5mm)	02→06	CR9EB	6955			CR9EIX	3521	0.6
	749, R, S (‡ Socket Ø <20.5mm)	03→06	CR9EB	6955			CR9EIX	3521	0.6
	750 Sport	00→02	DCPR8E*	4339			DCR8EIX	3606	0.7
750	750 F1	86→88	BP7HS	5111			BPR7HIX	5944	0.6
	750 F1	89→	DCPR8E*	4339			DCR8EIX	3606	0.7
	750 GT		B7HS	5110			BR7HIX	7067	0.5
	750 Monster	96→02	DCPR8E*	4339			DCR8EIX	3606	0.7
	750 Montjuich		BP7HS	5111			BPR7HIX	5944	0.6
	750 Paso	86→90	DCPR8E*	4339			DCR8EIX	3606	0.7
	750 SS	→90	B7HS	5110			BR7HIX	7067	0.5
	750 SS	91→01	DCPR8E*	4339			DCR8EIX	3606	0.7
750 SS i.e.	98→02	DCPR8E*	4339			DCR8EIX	3606	0.7	
803	800 Sport	03→04	DCPR8E*	4339			DCR8EIX	3606	0.7
	800 i.e. Monster	03→05	DCPR8E*	4339			DCR8EIX	3606	0.7
	Hypermotard 796 (Twin Spark)	10→12	DCPR8E*	4339			DCR8EIX	3606	0.7
	Monster 796	10→14	DCPR8E*	4339			DCR8EIX	3606	0.7
	S2R 800	05→08	DCPR8E*	4339			DCR8EIX	3606	0.7
	Scrambler Classic, Full Throttle, Icon, Urban Enduro	15→	DCPR8E*	4339			DCR8EIX	3606	0.7
	Scrambler Flat Track Pro	16→	DCPR8E*	4339			DCR8EIX	3606	0.7
	SS 800	03→04	DCPR8E*	4339			DCR8EIX	3606	0.7
821	Hypermotard	13→15	MAR9A-J	6869					0.8
	Hyperstrada	13→15	MAR9A-J	6869					0.8
	Monster 821, Monster 821 Dark	14→	MAR9A-J	6869					0.8
	Monster 821 Stripe	15→	MAR9A-J	6869					0.8
849	848	08→13	MAR10A-J	4706					0.8
	848 Evo, Evo Dark Stealth, Corse SE	07/10→13	MAR10A-J	4706					0.8
	Streetfighter 848	11/11→15	MAR10A-J	4706					0.8
851	851						DR9EIX	4772	0.6
	851 Strada	89→92					DR9EIX	4772	0.6
860	860 GT, GTS		B5HS	4210				0.6	
888	851 SP (Sport Production)	90→92					DR9EIX	4772	0.6
	888 SP (Sport Production)	92→94					DCR9EIX	6650	0.8
	888 Strada	→93					DR9EIX	4772	0.6
	888 Strada	94→	DR9EA	3437			DR9EIX	4772	0.6
898	899 Panigale	13→15	MAR9A-J	6869				0.8	
900	900 Darmah SS, SD		B6HS	4510			BR6HIX	3419	0.5
	900 i.e. Monster, Monster Dark	99→02	DCPR8E*	4339			DCR8EIX	3606	0.9
	900 Injection		DCPR8E*	4339			DCR8EIX	3606	0.9
	900 Monster, Monster S	97→	DCPR8E*	4339			DCR8EIX	3606	0.9
	900 SS, SSD, S2, Hailwood Replica	79→	B7HS	5110			BR7HIX	7067	0.6
	900 SS	91→	DCPR8E*	4339			DCR8EIX	3606	0.9
	900 Superlight	92→	DCPR8E*	4339			DCR8EIX	3606	0.9
	900 Supersport, FE	97→02	DCPR8E*	4339			DCR8EIX	3606	0.9
	906 Paso	88→94	DCPR8E*	4339			DCR8EIX	3606	0.9
907 I.E.	91→	DCPR8E*	4339			DCR8EIX	3606	0.9	

‡ Early Ducati Testastretta bikes (749, 998, 999 models) can have very little clearance between the plug hex and the cylinder head that may require a thin walled socket, no larger than 20.5mm OD to allow the plug to be fitted.



* Please note DCPR8E 4339 has a removable terminal nut, whereas DCPR8E 4179 has a fixed terminal nut





CC	MODEL	DATE	STANDARD COPPER CORE	STOCK NUMBER	PLATINUM OR GOLD PALLADIUM	STOCK NUMBER	IRIDIUM	STOCK NUMBER	GAP MM
DUCATI (CONTINUED)									
916	916 (All models except SP)	94→01					DCR9EIX	6650	0.8
	916 SP	94→	R2349-10	6839					0.6
	S4 Monster	01→02					DCR9EIX	6650	0.8
	ST4	98→03					DCR9EIX	6650	0.7
937	Hypermotard 939, 939 SP	16→18	MAR9A-J	6869					0.8
	Hypermotard 950	19→	MAR9A-J	6869					0.8
	Hyperstrada 939	16→	MAR9A-J	6869					0.8
	Multistrada 950 (Twin Spark)	17→	MAR9A-J	6869					0.8
	Supersport, S	17→	MAR9A-J	6869					0.8
944	ST2	97→03	DCPR8E*	4339			DCR8EIX	3606	0.9
955	959 Panigale, R	16→19	MAR9A-J	6869					0.8
989	Desmosedici RR	07→08	MAR10A-J	4706					0.8
992	GT1000 (Twin Spark)	06→10	DCPR8E*	4339			DCR8EIX	3606	0.9
	Monster 1000 i.e. (Twin Spark)	03→05	DCPR8E*	4339			DCR8EIX	3606	0.9
	Multistrada 1000DS, MTS 1000DS (Twin Spark)	03→06	DCPR8E*	4339			DCR8EIX	3606	0.9
	Paul Smart 1000 Limited Edition (Twin Spark)	05→06	DCPR8E*	4339			DCR8EIX	3606	0.9
	Monster S2R, Dark 1000 (Twin Spark)	10/05→07	DCPR8E*	4339			DCR8EIX	3606	0.9
	Sport 1000 (Twin Spark)	05→09	DCPR8E*	4339			DCR8EIX	3606	0.9
	SS 1000 DS (Twin Spark)	03→06	DCPR8E*	4339			DCR8EIX	3606	0.9
	ST3, S (Twin Spark)	03→07	CR9EB	6955			CR9EIX	3521	0.6
996	916 SPS Fogarty Replica	1998	R2349-10	6839					0.6
	996 B/S, Biposto	98→01					DCR9EIX	6650	0.8
	996 S	00→02					DCR9EIX	6650	0.8
	996 SPS	97→02	R2349-10	6839					0.6
	S4R Monster	03→06					DCR9EIX	6650	0.8
	ST4S	00→05					DCR9EIX	6650	0.8
998	996 R (‡ Socket Ø <20.5mm)	00→02	CR9EB	6955			CR9EIX	3521	0.6
	998 Biposto, R, S (‡ Socket Ø <20.5mm)	01→03	CR9EB	6955			CR9EIX	3521	0.6
	998 Matrix (‡ Socket Ø <20.5mm)	2003	CR9EB	6955			CR9EIX	3521	0.6
	999, R, S (‡ Socket Ø <20.5mm)	02→06	CR9EB	6955			CR9EIX	3521	0.6
	Panigale V4R	19→	LMDR10A-JS	97718					0.8
	S4RS Monster (‡ Socket Ø <20.5mm)	06→08	CR9EB	6955			CR9EIX	3521	0.6
	S4R Monster (‡ Socket Ø <20.5mm)	07→08	CR9EB	6955			CR9EIX	3521	0.6
1079	Hypermotard, S, Evo, Evo SP	07→12	DCPR8E*	4339			DCR8EIX	3606	0.9
	Monster 1100, S, Evo, Diesel	09→13	DCPR8E*	4339			DCR8EIX	3606	0.9
	Multistrada 1100, S	06→09	DCPR8E*	4339			DCR8EIX	3606	0.9
	Scrambler 1100, 1100 Special, 1100 Sport	18→	DCPR8E*	4339			DCR8EIX	3606	0.9
1098	1098, 1098S / Tricolore	07→08	MAR10A-J	4706					0.8
	Streetfighter S	09→13	MAR10A-J	4706					0.8
1103	Panigale V4 (Incl. S, 25° Anniversario 916)	18→	LMDR10A-JS	97718					0.8
1198	1098R (Incl. Bayliss LE)	2008	MAR10A-J	4706					0.8
	1198 R Corse	2010	MAR10A-J	4706					0.8
	1198, S, SP	09→11	MAR10A-J	4706					0.8
	1199 Panigale, R, S, S Tricolore (Incl. Senna)	12→14	MAR9A-J	6869					0.8
	1199 Superleggera	2014	MAR9A-J	6869					0.8
	Diavel (Incl. AMG, Carbon, Cromo & Diesel)	11→	MAR9A-J	6869					0.8
	Monster 1200, S, Stripe	14→	MAR9A-J	6869					0.8
	Monster 1200 R (Twin Spark)	16→	MAR9A-J	6869					0.8
	Multistrada 1200, S (Incl. Pikes Peak, Sport & Touring)	10→12	MAR9A-J	6869					0.8
	Multistrada 1200, S (Incl. Pikes Peak, Sport & Touring) Twin Spark	13→14	MAR10A-J	4706					0.8
	Multistrada 1200, D Air, S (Twin Spark)	2015	MAR9A-J	6869					0.8
1262	Multistrada 1200 Enduro, Pikes Peak, Pro (Twin Spark)	2016	MAR9A-J	6869					0.8
	Diavel 1260, 1260S	19→	MAR9A-J	6869					0.8
	Multistrada 1260, D Air, Enduro, Pike Peak (Twin Spark)	18→	MAR9A-J	6869					0.8
	Multistrada 1260 S, S Grand Tour (Twin Spark)	18→	MAR9A-J	6869					0.8
1285	XDiavel, S	16→	MAR9A-J	6869					0.8
	1299 Panigale, R, S (Incl. Anniversario)	15→	MAR9A-J	6869					0.8

‡ Early Ducati Testastretta bikes (749, 998, 999 models) can have very little clearance between the plug hex and the cylinder head that may require a thin walled socket, no larger than 20.5mm OD to allow the plug to be fitted.



* Please note DCPR8E 4339 has a removable terminal nut, whereas DCPR8E 4179 has a fixed terminal nut





CC	MODEL	DATE	STANDARD COPPER CORE	STOCK NUMBER	PLATINUM OR GOLD PALLADIUM	STOCK NUMBER	IRIDIUM	STOCK NUMBER	GAP MM
EBR									
1190	1190RX	04/14→	CR9EKB	2305			CR9EIX	3521	0.8
	1190SX	07/14→	CR9EKB	2305			CR9EIX	3521	0.8

FANTIC									
50	Caballero 50	06→	BR9ES	5722			BR9EIX	3981	0.7
	Gran Turismo, Lei 50, Issimo (all models)		B6HS	4510			BR6HIX	3419	0.5
	Trial 50	79→	B7HS	5110			BR7HIX	7067	0.5
80	Caballero 80		B8EG	3430			BR8EIX	5044	0.5
	Enduro 80		B8EG	3430			BR8EIX	5044	0.5
	RSX 80		B8EG	3430			BR8EIX	5044	0.5
	Section	95→97	BCP7ES	5030			BCPR7EIX	5690	0.5
125	Caballero 125		B9EG	3530			BR9EIX	3981	0.5
	Cross 125		B9EG	3530			BR9EIX	3981	0.5
	Professional 125		B6HS	4510			BR6HIX	3419	0.5
	RSX 125		B9EG	3530			BR9EIX	3981	0.5
	Trial 125	77→	B6HS	4510			BR6HIX	3419	0.5
160	TX160		B8EG	3430			BR8EIX	5044	0.5
175	Enduro 175		B8EG	3430			BR8EIX	5044	0.5
200	Trial 200	79→	B6HS	4510			BR6HIX	3419	0.5
240	Trial 240	82→	B6HS	4510			BR6HIX	3419	0.5
250	Section	95→97	BCP7ES	5030			BCPR7EIX	5690	0.5
	TX250		B8EG	3430			BR8EIX	5044	0.5
260	TX260		B8EG	3430			BR8EIX	5044	0.5
300	Professional 300		B8EG	3430			BR8EIX	5044	0.5
330	TX330		B8EG	3430			BR8EIX	5044	0.5

GAS GAS									
50	Contact, Endurocross		B8HS	5510			BR8HIX	7001	0.5
	EC 50 Boy (12.7mm Thread Reach)		B8HS	5510			BR8HIX	7001	0.5
	EC Boy, Rookie 50 (19mm Thread Reach)	04→	B9ES	2611			BR9EIX	3981	0.6
	SM 50 Supermotard	04→	B9ES	2611			BR9EIX	3981	0.6
	TXT Boy	06→	BPR5ES	7422			BPR5EIX	6597	0.5
65	MC65	06→	BR10ES	4832			BR10EIX	6801	0.7
75	Husqvarna (TM)		B10EG	3630			BR10EIX	6801	0.5
80	TXT 80	06→07	BPR5ES	7422			BPR5EIX	6597	0.5
	TXT PRO Racing	15→	BPR5ES	7422			BPR5EIX	6597	0.5
125	Contact T12	1993	BP5ES	6511			BPR5EIX	6597	0.5
	EC 125 Endurocross	97→	B9EG	3530			BR9EIX	3981	0.7
	EC 125 Racing, EC 125 SIX	10→	BR9EG	3230			BR9EIX	3981	0.7
	Enduro 125	02→	BR8EG	3130			BR8EIX	5044	0.5
	Endurocross TT125, Cross TT125	→00					BR10EIX	6801	0.5
	GT12 (Liquid Cooled)	1993	BP5ES	6511			BPR5EIX	6597	0.5
	Halley 125	2009	BR9ES	5722			BR9EIX	3981	0.7
	Husqvarna (TM)		B10EG	3630			BR10EIX	6801	0.5
	Pampera 125	02→05	BPR5ES	7422			BPR5EIX	6597	0.5
	SM 125 Supermotard	03→07	BR9EG	3230			BR9EIX	3981	0.7
	Trial 125	→91	BP5ES	6511			BPR5EIX	6597	0.5
	TX, TXT 125 Ø14mm Plug	99→	BPR5ES	7422			BPR5EIX	6597	0.5
	TX Randonne Ø10mm Plug	11→	CR6HSA	2983			CR6HIX	7274	0.6
TXT Pro, Racing	11→	BPR5ES	7422			BPR5EIX	6597	0.6	
143	Contact T16	1993	BP5ES	6511			BPR5EIX	6597	0.5
160	GT16 (Liquid Cooled)	1993	BP5ES	6511			BPR5EIX	6597	0.5
200	EC 200 Endurocross	99→					BR10EIX	6801	0.6
	EC 200 Endurocross (2002 models)	02→	BR8EG	3130			BR8EIX	5044	0.5
	EC 200 Racing	11→	BR8EG	3130			BR8EIX	5044	0.7
	Trial 200	→91	BP5ES	6511			BPR5EIX	6597	0.5
	TX, TXT 200	99→	BPR5ES	7422			BPR5EIX	6597	0.5
238	Contact JT25	94→95	BP5ES	6511			BPR5EIX	6597	0.5
249	TX, TXT 249	99→	BPR5ES	7422			BPR5EIX	6597	0.5
250	Contact 250	15→	BPR5ES	7422			BPR5EIX	6597	0.6
	Delta 25 GT	→91	BP5ES	6511			BPR5EIX	6597	0.5



CC	MODEL	DATE	STANDARD COPPER CORE	STOCK NUMBER	PLATINUM OR GOLD PALLADIUM	STOCK NUMBER	IRIDIUM	STOCK NUMBER	GAP MM
GAS GAS (CONTINUED)									
250	EC 250 Endurocross	1997	B8EG	3430			BR8EIX	5044	0.5
	EC 250 Racing, EC 250 SIX (Incl. Replica) (2-Stroke)	10→	BR8EG	3130			BR8EIX	5044	0.7
	ECF250 4T, ECF250 SIX (4-Stroke)	10→11	CR8E	1275			CR8EIX	4218	0.7
	ECF250 4T, ECF250 SIX (4-Stroke)	12→	CR9E	6263			CR9EIX	3521	0.6
	Enduro 250	02→	BR8EG	3130			BR8EIX	5044	0.5
	Endurocross 250	→00					BR10EIX	6801	0.5
	Husqvarna (TM)		B10EG	3630			BR10EIX	6801	0.5
	Pampera 250	02→05	BPR5ES	7422			BPR5EIX	6597	0.5
	Supermotard SM 250	03→05	BR8EG	3130			BR8EIX	5044	0.5
	Trial 250 (Air & Liquid Cooled models)	→91	BP5ES	6511			BPR5EIX	6597	0.5
TXT Pro, Raga Replica	03→	BPR5ES	7422			BPR5EIX	6597	0.6	
270	TX, TXT 270	98→	BPR5ES	7422			BPR5EIX	6597	0.5
280	Pampera 280	02→05	BPR5ES	7422			BPR5EIX	6597	0.5
	Trial 280	→91	BP5ES	6511			BPR5EIX	6597	0.5
	TX, TXT 280	00→	BPR5ES	7422			BPR5EIX	6597	0.5
	TXT Pro, Racing, Raga Replica	11→	BPR5ES	7422			BPR5EIX	6597	0.6
300	EC 300	98→02	BR8EG	3130			BR8EIX	5044	0.7
	EC 300 Endurocross	03→09					BR10EIX	6801	0.6
	EC 300 F (4-Stroke)	13→	CR9E	6263			CR9EIX	3521	0.6
	EC 300 Racing, EC 300 SIX (Incl. Replica) (2-Stroke)	10→	BR8EG	3130			BR8EIX	5044	0.7
	Enduro 300	02→	BR8EG	3130			BR8EIX	5044	0.5
	Trial 300	→91	BP5ES	6511			BPR5EIX	6597	0.5
	TXT 300	04→	BPR5ES	7422			BPR5EIX	6597	0.5
	TXT Pro, Racing, Raga Replica	11→	BPR5ES	7422			BPR5EIX	6597	0.6
321	TX, TXT 321	99→	BP5ES	6511			BPR5EIX	6597	0.5
325	Trial Halley PXC 325	→91	B9ES	2611			BR9EIX	3981	0.5
327	Trial 327	→91	BP5ES	6511			BPR5EIX	6597	0.5
330	Delta 32 GT	→91	BP5ES	6511			BPR5EIX	6597	0.5
400	Pampera 400	06→	CR8E	1275			CR8EIX	4218	0.7
	SM 400FSE-4T	02→	CR8E	1275			CR8EIX	4218	0.7
450	EC 450 (4-Stroke)	08→10	CR8E	1275			CR8EIX	4218	0.7
	EC 450 F (4-Stroke)	13→	CR8E	1275			CR8EIX	4218	0.7
	FSE 450	03→	CR8E	1275			CR8EIX	4218	0.7
	Halley 450 R	08→	CR8E	1275			CR8EIX	4218	0.7
	SM 450	04→	CR8E	1275			CR8EIX	4218	0.7
	SM Halley 450	2009	CR8E	1275			CR8EIX	4218	0.7
492	EC 515 FSR	08→10	CR8E	1275			CR8EIX	4218	0.7
	SM 515	08→10	CR8E	1275			CR8EIX	4218	0.7
500	Normada 500		D8EA	2120	DR8EVX	6354	DR8EIX	6681	0.5

GENERIC									
50	Cracker 50 (19mm Thread Reach)	07→11	BR7ES	5122			BR7EIX	6664	0.7
	Cracker SM 50 (12.7mm Thread Reach)	11→12	BR8HSA	5539			BPR8HIX	6742	0.7
	Epico 50	11→12	BR8HSA	5539			BPR8HIX	6742	0.7
	Evolution 50 (19mm Thread Reach)	07→11	BR7ES	5122			BR7EIX	6664	0.7
	Evolution 50 (12.7mm Thread Reach)	11→12	BR8HSA	5539			BPR8HIX	6742	0.7
	Ideo 50 (19mm Thread Reach)	07→11	BR7ES	5122			BR7EIX	6664	0.7
	Ideo 50 (12.7mm Thread Reach)	11→12	BR8HSA	5539			BPR8HIX	6742	0.7
	Race 50 (19mm Thread Reach)	→11	BR7ES	5122			BR7EIX	6664	0.7
	Race 50 (12.7mm Thread Reach)	11→12	BR8HSA	5539			BPR8HIX	6742	0.7
	ROC 50 (19mm Thread Reach)	→11	BR7ES	5122			BR7EIX	6664	0.7
	Trigger SM 50 (19mm Thread Reach)	07→11	BR7ES	5122			BR7EIX	6664	0.7
	Trigger SM 50 (12.7mm Thread Reach)	11→12	BR8HSA	5539			BPR8HIX	6742	0.7
	Trigger SM Competition (Restricted)	→11	BR7ES	5122			BR7EIX	6664	0.7
	Trigger SM Competition (Unrestricted)	→11	BR9ES	5722			BR9EIX	3981	0.7
	Trigger X 50 (19mm Thread Reach)	07→11	BR7ES	5122			BR7EIX	6664	0.7
	Trigger X 50 (12.7mm Thread Reach)	11→12	BR8HSA	5539			BPR8HIX	6742	0.7
	Trigger X Competition (Restricted)	→11	BR7ES	5122			BR7EIX	6664	0.7
	Trigger X Competition (Unrestricted)	→11	BR9ES	5722			BR9EIX	3981	0.7
	XOR 50 (19mm Thread Reach)	07→11	BR7ES	5122			BR7EIX	6664	0.7
	XOR 50 (12.7mm Thread Reach)	11→12	BR8HSA	5539			BPR8HIX	6742	0.7
	XOR 50 Competition (19mm Thread Reach)	07→11	BR7ES	5122			BR7EIX	6664	0.7



CC	MODEL	DATE	STANDARD COPPER CORE	STOCK NUMBER	PLATINUM OR GOLD PALLADIUM	STOCK NUMBER	IRIDIUM	STOCK NUMBER	GAP MM
GENERIC (CONTINUED)									
50	XOR Stroke 50 (2-Stroke)	07→11	BR7ES	5122			BR7EIX	6664	0.7
	XOR 50 Williams (19mm Thread Reach)	→11	BR7ES	5122			BR7EIX	6664	0.7
125	Soho 125	09→11	CR8E	1275			CR8EIX	4218	0.7
	XOR 125	07→11	CR7HSA	4549			CR7HIX	7544	0.7
	XOR 125 Williams	08→11	CR7HSA	4549			CR7HIX	7544	0.7

GILERA									
50	DNA 50 (2-Stroke catalyst)	00→	BR9ES	5722			BR9EIX	3981	0.7
	DNA 50 GP	02→	BR9ES	5722			BR9EIX	3981	0.6
	GSM 50 (Gilera 2-Stroke)	00→	BR9ES	5722			BR9EIX	3981	0.7
	H@K 50 (Gilera 2-Stroke)	00→	BR9ES	5722			BR9EIX	3981	0.7
	ICE 50 (Gilera 2-Stroke)	01→	BR9ES	5722			BR9EIX	3981	0.7
	Jetrunner	03→	CPR8E	7411			CR8EIX	4218	0.8
	Pure Jet 50 Direct Injection (2-Stroke)	04→	CPR8E	7411			CR8EIX	4218	0.8
	RCR 50 (2-Stroke Derbi engine)	04→	BR9ES	5722			BR9EIX	3981	0.5
	Runner 50 (2-Stroke)	97→02	BR9ES	5722			BR9EIX	3981	0.6
	Runner 50 (4-Stroke)	04→	CPR8E	7411			CR8EIX	4218	0.8
	SKP 50	97→	BR9ES	5722			BR9EIX	3981	0.5
	SMT 50	05→	BR9ES	5722			BR9EIX	3981	0.6
	Stalker 50	03→	BR9ES	5722			BR9EIX	3981	0.5
	Storm 50	09/07→	BR9ES	5722			BR9EIX	3981	0.6
125	125T G1,125GR1		B8ES	2411			BR8EIX	5044	0.5
	Cougar 125	00→03	DPR8EA-9	4929			DPR8EIX-9	2202	0.8
	Crono		B10EG	3630			BR10EIX	6801	0.6
	CX 125 Apache		B10EG	3630			BR10EIX	6801	0.6
	DNA 125 (4-Stroke)	01→	CR9EB	6955			CR9EIX	3521	0.7
	Freestyle (2-Stroke)		B10EG	3630			BR10EIX	6801	0.6
	GFR125						BR10EIX	6801	0.6
	Nexus 125	07→	CR8EB	7784			CR8EIX	4218	0.7
	Runner ST 125 (4-Stroke)	09→	CR9E	6263			CR9EIX	3521	0.6
	Runner FX125 (2-Stroke)	97→01	BR9ES	5722			BR9EIX	3981	0.6
	Runner VX 125 (4-Stroke)	01→08	CR9EB	6955			CR9EIX	3521	0.7
	RV 125	86→90	B10EG	3630			BR10EIX	6801	0.6
	SC125 (2-Stroke)	06→	BR8ES	5422			BR8EIX	5044	0.7
	SC125 (4-Stroke Yamaha engine)	07→	BR8ES	5422			BR8EIX	5044	0.7
180	DNA 180 (4-Stroke)	01→	CR9EB	6955			CR9EIX	3521	0.7
	Runner FXR180 (2-Stroke)	98→00	BR9ES	5722			BR9EIX	3981	0.6
	Runner VXR 180 (4-Stroke)	01→08	CR9EB	6955			CR9EIX	3521	0.7
200	Runner ST 200	08→	CPR8E	7411			CR8EIX	4218	0.7
	Runner VXR 200 (4-Stroke)	02→08	CPR8E	7411			CR8EIX	4218	0.7
250	Nexus 250 SP	06→	CR8EB	7784			CR8EIX	4218	0.6
300	Nexus 300		CR8EKB	4374			CR8EIX	4218	0.7
	Dakota 350 (4-Stroke)		DPR8EA-9	4929			DPR8EIX-9	2202	0.6
350	Saturno 350 (4-Stroke)	90→	DPR8EA-9	4929			DPR8EIX-9	2202	0.6
	Nexus 500	04→	CR7EKB	4455			CR7EIX	7385	0.8
500	Dakota 500 (4-Stroke)		DPR8EA-9	4929			DPR8EIX-9	2202	0.6
	Fuoco 500	07→	CR7EKB	4455			CR7EIX	7385	0.8
	Saturno 500 (4-Stroke)	90→93	DPR8EA-9	4929			DPR8EIX-9	2202	0.6
560	Nordwest 600 (4-Stroke)	91→95	DPR9EA-9	5329			DPR9EIX-9	5545	0.6
	RC600 (4-Stroke)		DPR8EA-9	4929			DPR8EIX-9	2202	0.6
600	Supersport 600	02→	CR9E	6263			CR9EIX	3521	0.6
839	GP800 (Twin Spark)	08→	CR7EKB	4455			CR7EIX	7385	0.8

HARLEY DAVIDSON									
500	Street 500	15→	CR8E	1275			CR8EIX	4218	0.7
700	Street 750	15→	CR8E	1275			CR8EIX	4218	0.7
883	XL53C, Sportster 883 (All Models)	86→	DCPR7EA-9	6651			DCPR7EIX	6046	0.9
	XL883 Iron	09→	DCPR7EA-9	6651			DCPR7EIX	6046	0.9
1000	XL, XLH, XLCH	→78	B-6L	3212					0.7
	XLCR	→79	B-6L	3212					0.7
	XLH, XLS, XLCH	79→	BP6HS	4511			BPR6HIX	4085	1.0



CC	MODEL	DATE	STANDARD COPPER CORE	STOCK NUMBER	PLATINUM OR GOLD PALLADIUM	STOCK NUMBER	IRIDIUM	STOCK NUMBER	GAP MM
HARLEY DAVIDSON (CONTINUED)									
1000	XR1000	83→85	BPR6ES-11	4824			BPR6EIX-11	3903	1.0
1100	Sportster 1100	86/87	DCPR7E	3932			DCPR7EIX	6046	1.0
1130	VRSC V-Rod, Night Rod, Street Rod	02→	DCPR8E*	4339			DCR8EIX	3606	0.9
1200	FL, FLH, FX, FXE, Super Glide	48→74	BP5S	3011					0.7
	FLH, FLHR, FX, FXE, FXEF, FXS	75→81	BPR5ES-11	4424			BPR5EIX	6597	1.0
	Forty Eight	10→	DCPR7E	3932			DCPR7EIX	6046	1.0
	Sportster 1200 (All Models)	88→	DCPR7E	3932			DCPR7EIX	6046	1.0
	XL1200	88→	DCPR7E	3932			DCPR7EIX	6046	1.0
	XR1200	08→12	DCPR9E	2641			DCPR9EIX	2316	0.9
1250	V-Rod Anniversary	11→	DCPR9E	2641			DCPR9EIX	2316	0.6
	VRSC Screamin' Eagle V-Rod	04→	DCPR9E	2641			DCPR9EIX	2316	0.6
	VRSCF V-ROD MUSCLE	09→14	DCPR9E	2641			DCPR9EIX	2316	0.6
1340	All Evolution engines	84→98	BPR5ES-11	4424			BPR5EIX	6597	1.0
	All Shovel Head engines	82→84	ZGR5A	5839					1.0
1450	All 1450cc Models	99→	DCPR7E	3932			DCPR7EIX	6046	1.0
	FXDBi	06→	DCPR7E	3932			DCPR7EIX	6046	1.0
1584	Blackline	11→	DCPR8E*	4339			DCR8EIX	3606	0.9
	FLST Fat Boy	08/06→	DCPR8E*	4339			DCR8EIX	3606	0.9
	Twin Cam 96B Models	06/06→	DCPR8E*	4339			DCR8EIX	3606	0.9
	Wide Glide	10→	DCPR8E*	4339			DCR8EIX	3606	0.9
1690	FL1690 Screamin' Eagle Electra Glide	04→	DCPR8E*	4339			DCR8EIX	3606	0.9
	FL1690 Screamin' Eagle, Fat Boy	04→	DCPR8E*	4339			DCR8EIX	3606	0.9
	FXSB	13→	DCPR8E*	4339			DCR8EIX	3606	0.9
	Switchback	11→	DCPR8E*	4339			DCR8EIX	3606	0.9
1745	Twin spark heads	17→	CR9E	6263			CR9EIX	3521	0.6
1800	FLHR Road King	13→	DCPR7E	3932			DCPR7EIX	6046	1.0
	FLHTCUSE Screamin' Eagle, Ultra Classic Electra Glide	06/06→	DCPR7E	3932			DCPR7EIX	6046	1.0

HERALD MOTOR COMPANY									
125	Classic 125	06/12→	CR7E	4578			CR7EIX	7385	0.5
250	Classic 250	06/12→	DR8EA	7162			DR8EIX	6681	0.5
	Nomad 250 custom	04/16→	DR8EA	7162			DR8EIX	6681	0.5
	Rambler 250 custom	04/16→	DR8EA	7162			DR8EIX	6681	0.5
	Roamer 250 custom	04/16→	DR8EA	7162			DR8EIX	6681	0.5
	Vagabond 250 custom	04/16→	DR8EA	7162			DR8EIX	6681	0.5

HERO-PUCH									
50	Blinker, Stark, Turbo Sport	94→	BP5ES	6511			BPR5EIX	6597	0.5

HESKETH									
1000	V1000	82→	DR8ES	5423			DR9EIX	4772	0.7

HONDA									
50	C50	66→78	C7HSA	4629			CR7HIX	7544	0.7
	C50C	82→86	CR7HS	7223			CR7HIX	7544	0.7
	C50-E Super Cub	84→85	CR7HS	7223			CR7HIX	7544	0.7
	C50L, C50LA-C, C50LA-E	82→88	CR7HS	7223			CR7HIX	7544	0.7
	C50ZZ, C50Z2	77→83	CR7HS	7223			CR7HIX	7544	0.7
	CB50J	77→86	CR6HS	7023			CR6HIX	7274	0.7
	CR50R-E/F/G	84→86	BR9ES	5722			BR9EIX	3981	0.7
	CRF50F	04→	CR6HSA	2983			CR6HIX	7274	0.6
	MB50A-B	80→82	BR7HS	4122			BR7HIX	7067	0.7
	MBX50S-D	83→86	BR6ES	4922					0.7
	Melody, Mini Melody, Vision	83→85	BPR6HSA	4632			BPR6HIX	4085	0.7
	MT50A-B, MT50S-L	80→93	BR7HS	4122			BR7HIX	7067	0.7
	MTX50S-C	82→85	BR7HS	4122			BR7HIX	7067	0.7



* Please note DCPR8E 4339 has a removable terminal nut, whereas DCPR8E 4179 has a fixed terminal nut





CC	MODEL	DATE	STANDARD COPPER CORE	STOCK NUMBER	PLATINUM OR GOLD PALLADIUM	STOCK NUMBER	IRIDIUM	STOCK NUMBER	GAP MM
HONDA (CONTINUED)									
50	NC50 Express	77→84	BPR4HS	7823					0.7
	ND50M-C	83→85	BPR6HSA	4632			BPR6HIX	4085	0.7
	NE50	85→90	BPR6HSA	4632			BPR6HIX	4085	0.7
	NPS50 Zoomer	06→12	ER8EH-N	5606					0.7
	NS50MS	81→85	BPR6HSA	4632			BPR6HIX	4085	0.7
	NSC50 Vision	12→	CR7HSA-9	5147			CR7HIX	7544	0.9
	NSC50R	13→	CR7HSA-9	5147			CR7HIX	7544	0.9
	NT50-H	87→94	BPR6HSA	4632			BPR6HIX	4085	0.7
	NU50M-C	82→85	BPR5HS	6222					0.7
	NV50MS-D	82→87	BPR5HS	6222					0.7
	NX50M	80→83	BPR5HS	6222					0.7
	PA50VC	86→91	BPR6HS	7022			BPR6HIX	4085	0.7
	PC50 (OHC)	→69	C6HSA	3228			CR6HIX	7274	0.6
	PC50K (OHV)	70→79	C7HSA	4629			CR7HIX	7544	0.6
	PF50MR2	75→78	B6HS	4510			BR6HIX	3419	0.7
	PX50	81→86	BPR5HS	6222					0.7
	PXR50	85→87	BPR4HS	7823					0.7
	QR50-D, QR50-F/R	82→03	BPR4HS	7823					0.7
	SA50-J, SA50M/N/P	88→95	BPR6HSA	4632			BPR6HIX	4085	0.7
	SFX50 S, T, V, W, X, Y	95→03	BR6HSA	4296			BPR6HIX	4085	0.6
	SGX50 V, W, X, Y (Sky)	97→03	BR6HSA	4296			BPR6HIX	4085	0.6
	SH50E-S	84→96	BPR6HS	7022			BPR6HIX	4085	0.7
	SH50T-X-Y Bali	96→03	BR6HSA	4296			BPR6HIX	4085	0.6
	SJ50 P,R, S, V, W	93→99	BR6HSA	4296			BPR6HIX	4085	0.6
	SRX50 Shadow	2003	BR6HSA	4296			BPR6HIX	4085	0.6
	SS50	67→80	C7HSA	4629			CR7HIX	7544	0.6
	ST50J DAX, ST50J/K	88→93	CR6HSA	2983			CR6HIX	7274	0.7
	SZX-50 (X8R-S, X8R-X)	98→04	BR6HSA	4296			BPR6HIX	4085	0.6
	TLM50	85→86	B8ES	2411			BR8EIX	5044	0.7
	X8R S/X	98→03	BR6HSA	4296			BPR6HIX	4085	0.6
	XR50	96→02	CR6HSA	2983			CR6HIX	7274	0.7
	XR50R	00→03	CR6HSA	2983			CR6HIX	7274	0.7
	XR50 Motard	05→06	CR6HSA	2983			CR6HIX	7274	0.9
Z50R-D	79→99	CR6HS	7023			CR6HIX	7274	0.7	
60	CR60R-G	83→86	BR9ES	5722			BR9EIX	3981	0.7
70	C70C/E	82→86	CR7HS	7223			CR7HIX	7544	0.7
	CRF70F	04→12	CR6HSA	2983			CR6HIX	7274	0.6
	CZ70ZZ, CZ70Z2, C70/C, CF70/C	77→83	CR7HS	7223			CR7HIX	7544	0.7
	XR70V, XR70R	97→03	CR6HSA	2983			CR6HIX	7274	0.6
80	CR80RB	81→82	B9EG	3530			BR9EIX	3981	0.7
	CR80R-D/E/F/2F/G/2G	83→86	BR9ES	5722			BR9EIX	3981	0.7
	CR80RH-RS/T/V	87→99	BR10EG	3830			BR10EIX	6801	0.5
	CR80R, CR80R2	00→02	BR10EG	3830			BR10EIX	6801	0.5
	MBX80FWD-D	83→86	BR9ES	5722			BR9EIX	3981	0.7
	MTX80R-E	83→86	BR8ES	5422			BR8EIX	5044	0.7
	NH80MD/H-P	82→96	BPR6HS	7022			BPR6HIX	4085	0.7
	XR80R-J	79→03	CR7HS	7223			CR7HIX	7544	0.7
85	CR85R/R2	03→06	BR10EG	3830			BR10EIX	6801	0.5
90	C90 ZZ (Step Thru)	79→83	D6HA	6512					0.7
	C90E-C/E/G, C90MF-T (Step Thru)	84→96	CR7HS	7223			CR7HIX	7544	0.7
	C90MT (Step Thru)	96→03	CR6HSA	2983			CR6HIX	7274	0.6
	CM90, CM91	67→69	D6HA	6512					0.7
	EZ90-M	90→96	BR7HS	4122			BR7HIX	7067	0.7
	S90	64→69	D6HA	6512					0.7
	SRX90 Joker	96→00	BR6HSA	4296			BPR6HIX	4085	0.6
100	CB100 (N/NA/NB)	78→86	DR8ES-L	2923	DR8EVX	6354	DR8EIX	6681	0.7
	CRF100F	04→13	CR7HSA	4549			CR7HIX	7544	0.6
	H100A/B/S2G	80→92	BR7HS	4122			BR7HIX	7067	0.7
	H100SE/J	86→93	BR8HS	4322			BR8HIX	7001	0.7
	SCV100 Lead	03→06	CR6HSA	2983			CR6HIX	7274	0.6
	SJ100T-V-W (Bali)	97→99	BR6HSA	4296			BPR6HIX	4085	0.6
	XR100 Motard	05→06	CR7HSA	4549			CR7HIX	7544	0.9
	XR100R	85→03	CR7HSA	4549			CR7HIX	7544	0.6



CC	MODEL	DATE	STANDARD COPPER CORE	STOCK NUMBER	PLATINUM OR GOLD PALLADIUM	STOCK NUMBER	IRIDIUM	STOCK NUMBER	GAP MM
HONDA (CONTINUED)									
108	NHX110 Lead (Fi)	08→10	CR8EH-9	5666			CR8EHIX-9	3797	0.9
	NSC110 Vision	11→16	CPR8EA-9	2306			CR8EIX	4218	0.9
	NSC110 Vision	17→	MR8C-9N	97985					0.9
109	AFS110 Wave 110i	12→	CPR6EA-9S	1582					0.9
	CRF110F	12→13	CPR6EA-9S	1582					0.9
125	ANF125 Innova	03→06	CPR6EA-9	6899					0.9
	ANF125i Innova	07→	CPR6EA-9	6899					0.9
	C125 Super Cub	18→	CPR6EA-9	6899					0.9
	CA125S	95→99	CR6HSA	2983			CR6HIX	7274	0.6
	CB92 Ø10mm Plug	59→64	CR7HS	7223			CR7HIX	7544	0.7
	CB92 Ø12mm Plug	59→64	D8HA	7112					0.7
	CB125 (S/S1/J)	71→79	D8EA	2120	DR8EVX	6354	DR8EIX	6681	0.7
	CB125F	15→	CPR7EA-9	3901			CR7EIX	7385	0.9
	CB125RS-D/E	83→86	DR8ES-L	2923	DR8EVX	6354	DR8EIX	6681	0.7
	CB125T (2/B/D-C/D/D-E)	82→88	CR8HS	7423			CR8HIX	7669	0.7
	CBF125	08→14	CPR7EA-9	3901			CR7EIX	7385	0.9
	CBR125R	04→	CR8E	1275			CR8EIX	4218	0.7
	CD125 Benly	82→85	CR7HS	7223			CR7HIX	7544	0.7
	CG125 C→T	76→96	DR8ES-L	2923	DR8EVX	6354	DR8EIX	6681	0.7
	CG125 W→	97→08	DPR8EA-9	4929			DPR8EIX-9	2202	0.9
	CH125-D/E	83→87	DPR7EA-9	5129			DPR7EIX-9	7803	0.9
	CLR125 City Fly	98→03	DPR8EA-9	4929			DPR8EIX-9	2202	0.8
	CM125C-C	82→86	CR7HS	7223			CR7HIX	7544	0.7
	CR125/RB	80→82	B9EG	3530			BR9EIX	3981	0.5
	CR125R D-Y	83→00	BR9EG	3230			BR9EIX	3981	0.5
	CRF125F	14→	CPR6EA-9	6899					0.9
	CT125C	82→85	DR8ES-L	2923	DR8EVX	6354	DR8EIX	6681	0.7
	FES 125 Pantheon (2-Stroke)	98→02	BR8ES	5422			BR8EIX	5044	0.6
	FES 125 Pantheon (4-Stroke)	03→07	CR8EH-9	5666			CR8EHIX-9	3797	0.9
	FES 125 S-Wing 125	07→12	CR8EH-9	5666			CR8EHIX-9	3797	0.9
	MBX125FE/RW-F/H/L	84→86	BR8ES	5422			BR8EIX	5044	0.7
	Monkey 125	18→	CPR6EA-9	6899					0.9
	MSX125	13→	CPR6EA-9	6899					0.9
	MTX125R-D/E/F	83→94	BR8ES	5422			BR8EIX	5044	0.7
	NES125 @	00→03	CR8EH-9	5666			CR8EHIX-9	3797	0.9
	NH125MD-D	83→87	BPR6HS	7022			BPR6HIX	4085	0.7
	NS125FG/FH/RK-RP	86→93	BR7ES	5122			BR7EIX	6664	0.7
	NSR125 F R/S	88→89	BR9ECS	3570					0.7
	NSR125R-R-S-V	90→03	BR9ECS	3570					0.7
	NSS125 Forza	15→					SILMAR8C9	90097	0.9
	PCX125 (WW)	10→17	CPR7EA-9	3901			CR7EIX	7385	0.9
	PS125i (PES125i)	07→13	CR8EH-9	5666			CR8EHIX-9	3797	0.9
SES125 Dylan	02→07	CR8EH-9	5666			CR8EHIX-9	3797	0.9	
SH125	01→08	CR8EH-9	5666			CR8EHIX-9	3797	0.9	
SH125i	09→12	CR8EH-9	5666			CR8EHIX-9	3797	0.9	
SH125i	13→	CPR7EA-9	3901			CR7EIX	7385	0.9	
SH Mode 125	14→16	CPR7EA-9	3901			CR7EIX	7385	0.9	
SH Mode 125	17→	MR7G-9E	90312					0.9	
SS125	67→69	D8HA	7112					0.7	
VT125 /C2 Shadow	98→07	CR8EH-9	5666			CR8EHIX-9	3797	0.8	
XL125 (S/SA/SB/RO/RF)	75→87	DR8ES-L	2923	DR8EVX	6354	DR8EIX	6681	0.7	
XL125V Varadero	01→	CR8EH-9	5666			CR8EHIX-9	3797	0.9	
XLR125R	97→99	DPR8EA-9	4929			DPR8EIX-9	2202	0.8	
XR125L	03→13	DPR8EA-9	4929			DPR8EIX-9	2202	0.8	
175	CB175 (Incl. 'Sloper')	68→73	D8HA	7112					0.6
150	FES150 Pantheon	05→09	CR8EH-9	5666			CR8EHIX-9	3797	0.9
	CRF150R/R2	07→	CR8EH-9	5666			CR8EHIX-9	3797	0.9
	CRF150R/B	09→	CR8EH-9	5666			CR8EHIX-9	3797	0.9
185	CD185T	78→82	CR7HS	7223			CR7HIX	7544	0.7
	XL185S (2/A/B)	79→84	DR8ES-L	2923	DR8EVX	6354	DR8EIX	6681	0.7
200	CB200	76→79	D8EA	2120	DR8EVX	6354	DR8EIX	6681	0.7
	CD200T (A/B), CM200T (A/B)	80→85	CR7HS	7223			CR7HIX	7544	0.7
	MTX200RW-D	83→86	BR9ES	5722			BR9EIX	3981	0.7



CC	MODEL	DATE	STANDARD COPPER CORE	STOCK NUMBER	PLATINUM OR GOLD PALLADIUM	STOCK NUMBER	IRIDIUM	STOCK NUMBER	GAP MM	
HONDA (CONTINUED)										
200	TLR200R-E/F	83→87	DR8ES-L	2923	DR8EVX	6354	DR8EIX	6681	0.7	
	XR200 (A/R-C)	80→83	DR8ES-L	2923	DR8EVX	6354	DR8EIX	6681	0.7	
230	CRF230F	03→12	DPR8EA-9	4929			DPR8EIX-9	2202	0.8	
250	CB250 K2,K3,K4,G5	73→77	B8ES	2411			BR8EIX	5044	0.7	
	CB250N A/B/DXB	78→83	DR8ES	5423			DR9EIX	4772	0.7	
	CB250N/T/W	92→03	CR6HSA	2983			CR6HIX	7274	0.7	
	CB250RS (A/B)	80→83	DR8ES-L	2923	DR8EVX	6354	DR8EIX	6681	0.7	
	CB250RSD-C	82→84	DR8ES	5423			DR9EIX	4772	0.7	
	CB250T Dream	77→81	DR8ES-L	2923	DR8EVX	6354	DR8EIX	6681	0.7	
	CBF250	04→06	CR8EH-9S	7750			CR8EHIX-9	3797	0.9	
	CBR250R	11→14					SIMR8A9	91064	0.9	
	CBX250RSE	84→86	DPR8EA-9	4929			DPR8EIX-9	2202	0.9	
	CD250U-J/K	88→93	CR6HSA	2983			CR6HIX	7274	0.7	
	CH250F/G (Spacy)	85→87	DPR6EA-9	5531					0.9	
	CL250S-C	82→84	DR8ES-L	2923	DR8EVX	6354	DR8EIX	6681	0.7	
	CM250T	82→84	DR8ES	5423			DR9EIX	4772	0.7	
	CMX250C-T	95→99	CR6HSA	2983			CR6HIX	7274	0.6	
	CN250-L/M/N	90→92	DPR6EA-9	5531					0.9	
	CR250 R3/R-D/E/F/G/H			BR8EG	3130			BR8EIX	5044	0.5
	CR250R-J			BR9EG	3230			BR9EIX	3981	0.5
	CR250R-S/T/V			BR8EG	3130			BR8EIX	5044	0.5
	CR250R K5	05→		BR9EG-N-8	2689					0.8
	CRF250L	12→						SIMR8A9	91064	0.9
	CRF250M	13→						SIMR8A9	91064	0.9
	CRF250R K5/K6 (19mm Thread Reach)	04→09						R0409B-8	7791	0.7
	CRF250R (26.5mm Thread Reach)	10→						R0451B-8	9356	0.7
	CRF250RX	18→19						R0451B-8	9356	0.7
	CRF250X K5-L4	04→						IMR8C-9H	3653	0.9
	FES250 W-X-Y (Foresight)	97→03		DPR7EA-9	5129			DPR7EIX-9	7803	0.9
	RTL250			D6EA	7512					0.7
	TL250			D7EA	7912					0.7
	TLR250F			DR8ES-L	2923	DR8EVX	6354	DR8EIX	6681	0.7
	VT250F-D	83→87		DPR8EA-9	4929			DPR8EIX-9	2202	0.9
	XL250/K3			D8EA	2120	DR8EVX	6354	DR8EIX	6681	0.7
	XL250R-C	82→84		DR8ES-L	2923	DR8EVX	6354	DR8EIX	6681	0.7
	XL250RE	84→86		DPR9Z	4830					0.7
	XL250S (A/B/Z)	73→82		DR8ES-L	2923	DR8EVX	6354	DR8EIX	6681	0.7
XR250	→84		D8EA	2120	DR8EVX	6354	DR8EIX	6681	0.7	
XR250RE	84→95		DPR9Z	4830					0.7	
XR250RT/V	96→01		CR9EH-9	7502			CR9EHIX-9	6216	0.9	
XR250	01→04		CR9EH-9	7502			CR9EHIX-9	6216	0.9	
280	SH300i	07→	LMAR8A-9	4313					0.9	
	NSS300 Forza	13→	LMAR8A-9	4313					0.9	
286	CB300R Neo Sports Café	18→					SIMR8A9	91064	0.9	
	CBR300R	15→					SIMR8A9	91064	0.9	
350	CB350SG	86→88	DR8ES-L	2923	DR8EVX	6354	DR8EIX	6681	0.7	
	XR350R-D		DPR8EA-9	4929			DPR8EIX-9	2202	0.9	
	XR350R-E		DPR7EA-9	5129			DPR7EIX-9	7803	0.9	
360	CB360G		B8ES	2411			BR8EIX	5044	0.7	
400	CB400 (N/NA/NC/T)	78→85	DR8ES	5423			DR9EIX	4772	0.7	
	CB400F1, F2	89→91	D8EA	2120	DR8EVX	6354	DR8EIX	6681	0.7	
	NS400RF	85→88	BR9ES	5722			BR9EIX	3981	0.7	
	VF400F-D	83→86	DPR8EA-9	4929			DPR8EIX-9	2202	0.9	
	VFR400 R3-L-P	90→93	ER9EH	5869					0.7	
	XR400RT/V			DPR8Z	4730				0.6	
450	CB450DX-K	89→92	DR8ES	5423			DR9EIX	4772	0.7	
	CRF450L	19→					SILMAR9A9S	6213	0.9	
	CRF450R (19mm Thread Reach)	02→08					IFR8H11	5068	1.1	
	CRF450R (26.5mm Thread Reach)	09→					SILMAR9A9S	6213	0.9	
	CRF450RX	17→					SILMAR9A9S	6213	0.9	
	CRF450X	05→					IFR8H11	5068	1.1	
480	CR480R-D		B8EG	3430			BR8EIX	5044	0.5	
500	CB500F	03/13→	CPR8EA-9	2306			CR8EIX	4218	0.9	



CC	MODEL	DATE	STANDARD COPPER CORE	STOCK NUMBER	PLATINUM OR GOLD PALLADIUM	STOCK NUMBER	IRIDIUM	STOCK NUMBER	GAP MM	
HONDA (CONTINUED)										
500	CB500 T	75→80	B8ES	2411			BR8EIX	5044	0.7	
	CB500 R, T, V, W, X, Y	94→	CR8EH-9	5666			CR8EHIX-9	3797	0.9	
	CB500S-W (Half Fairing)	98→	CR8EH-9	5666			CR8EHIX-9	3797	0.9	
	CB500X	05/13→	CPR8EA-9	2306			CR8EIX	4218	0.9	
	CBF500	04→	CR8EH-9S	7750			CR8EHIX-9	3797	0.9	
	CBR500R	03/13→	CPR8EA-9	2306			CR8EIX	4218	0.9	
	CR500R-E S, T, V, W, X	93→	BR8EG	3130			BR8EIX	5044	0.5	
	CX500 (Z, A, B, CA, DA, CB, EC)	78→84	DR8ES-L	2923		DR8EVX	6354	DR8EIX	6681	0.7
	CX500 TURBO	82→84						DPR8EIX-9	2202	0.9
	FT500-C	82→84	DR8ES	5423				DR9EIX	4772	0.7
	GL500 Silverwing	82→84	DR8ES-L	2923		DR8EVX	6354	DR8EIX	6681	0.6
	VF500F 2E/2F	84→87	DPR8EA-9	4929				DPR8EIX-9	2202	0.9
	VT500E-D/F	83→88	DPR8EA-9	4929				DPR8EIX-9	2202	0.9
	XBR500F/H/SJ	85→89	DPR8EA-9	4929				DPR8EIX-9	2202	0.9
	XL500 (SA,RC)	79→84	DR8ES-L	2923		DR8EVX	6354	DR8EIX	6681	0.7
	XR500		DR8ES-L	2923		DR8EVX	6354	DR8EIX	6681	0.7
550	CB550		DR7ES	3123					0.7	
	CBX550F (C,2-C)	82→86	DR8ES	5423			DR9EIX	4772	0.7	
600	CB600F (Hornet)	98→06	CR9EH-9	7502			CR9EHIX-9	6216	0.9	
	CB600F (Hornet)	07→	CR9EH-9	7502			CR9EHIX-9	6216	0.9	
	CB600FA (Hornet with ABS)	08→	CR9EH-9	7502			CR9EHIX-9	6216	0.9	
	CBF600 N/S (Incl. ABS)	04→07	CR9EH-9	7502			CR9EHIX-9	6216	0.9	
	CBF600 N/S (Incl. ABS)	08→	CR8EH-9	5666			CR8EHIX-9	3797	0.9	
	CBR600F H, J	87→88	DPR8EA-9	4929			DPR8EIX-9	2202	0.9	
	CBR600F K, L	89→90	DPR9EA-9	5329			DPR9EIX-9	5545	0.9	
	CBR600F M, N, P, R, S, T, V, W	91→98	CR9EH-9	7502			CR9EHIX-9	6216	0.9	
	CBR600F X, Y	99→00	CR9EH-9	7502			CR9EHIX-9	6216	0.9	
	CBR600FI / FSI Injection	2001					IMR9A-9H	6966	0.9	
	CBR600F Injection	02→07					IMR9C-9H	6777	0.9	
	CBR600F Sport	02→07					IMR9C-9H	6777	0.9	
	CBR600F	03/11→	CR9EH-9	7502			CR9EHIX-9	6216	0.9	
	CBR600RR	03/03→08					IMR9C-9HES	5766	0.9	
	CBR600RR (Incl. ABS)	09→					IMR9E-9HES	7556	0.9	
	FJS600 Silverwing (Incl. ABS)	01→	CR8EH-9	5666			CR8EHIX-9	3797	0.9	
	NTV600K/M Revere	88→93	DPR8EA-9	4929			DPR8EIX-9	2202	0.9	
	VT600C N, P, R, S, T, V, W	92→01	DPR8EA-9	4929			DPR8EIX-9	2202	0.9	
	XL600LM-F	84→86	DPR8EA-9	4929			DPR8EIX-9	2202	0.9	
XL600R D, E	84→86	DPR8EA-9	4929			DPR8EIX-9	2202	0.9		
XL600VH-VX (Transalp)	87→00	DPR8EA-9	4929			DPR8EIX-9	2202	0.9		
XR600R-V		DPR8EA-9	4929			DPR8EIX-9	2202	0.8		
650	CB650 Z, 2, B	78→82	DR8ES-L	2923		DR8EVX	DR8EIX	6681	0.7	
	CB650 SC-C (Nighthawk)	82→84	DR8ES-L	2923		DR8EVX	DR8EIX	6681	0.7	
	CB650FA	14→	CR9EH-9	7502			CR9EHIX-9	6216	0.9	
	CBR650FA	14→	CR9EH-9	7502			CR9EHIX-9	6216	0.9	
	CX650E-D	83→86	DPR8EA-9	4929			DPR8EIX-9	2202	0.9	
	CX650TC-D	83→85	DPR8EA-9	4929			DPR8EIX-9	2202	0.9	
	FMX650	05→08	DPR8EA-9	4929			DPR8EIX-9	2202	0.9	
	FX650 Vigor	99→03	DPR8EA-9	4929			DPR8EIX-9	2202	0.9	
	GL650 Silverwing	83→87	DPR8EA-9	4929			DPR8EIX-9	2202	0.9	
	NT650V-W-X-Y (Deauville)	98→05	DPR8EA-9	4929			DPR8EIX-9	2202	0.9	
	NTV650P-T/V	92→97	DPR8EA-9	4929			DPR8EIX-9	2202	0.9	
	NX650K-T-V-W-X Dominator	88→03	DPR8EA-9	4929			DPR8EIX-9	2202	0.9	
	SLR650	96→99	DPR8EA-9	4929			DPR8EIX-9	2202	0.8	
	XL650 /-V (Transalp)	00→07	DPR8EA-9	4929			DPR8EIX-9	2202	0.9	
	XR650R, R-2		BKR7E-11	1283					1.0	
	670	NC700D Integra	12→13					IFR6G-11K	1314	1.1
		NC700S/X	12→13					IFR6G-11K	1314	1.1
680	DN-01	08→11					SIMR8A9	91064	0.9	
	NT700V Deauville (Incl. ABS)	06→	CPR8EA-9	2306			CR8EIX	4218	0.9	
	XL700V Transalp (Incl. ABS)	08→	CPR8EA-9	2306			CR8EIX	4218	0.9	
745	NC750 Integra	14→					IFR6G-11K	1314	1.1	
	NC750S/X	14→					IFR6G-11K	1314	1.1	
	NM4 Vultus	14→					IFR6G-11K	1314	1.1	



CC	MODEL	DATE	STANDARD COPPER CORE	STOCK NUMBER	PLATINUM OR GOLD PALLADIUM	STOCK NUMBER	IRIDIUM	STOCK NUMBER	GAP MM
HONDA (CONTINUED)									
750	CB750 (SOHC)	70→78	D8EA	2120	DR8EVX	6354	DR8EIX	6681	0.7
	CB750 (DOHC)	79→84	DR8ES	5423			DR9EIX	4772	0.7
	CB Seven Fifty	92→02	DPR8EA-9	4929			DPR8EIX-9	2202	0.9
	CBX750FE	84→86	DPR8EA-9	4929			DPR8EIX-9	2202	0.9
	NR (750)	1992	ER9EH	5869					0.7
	RVF750R-S (RC45)	94→98					CR9EHIX-9	6216	0.9
	VF750 (C/F/S)		DPR8EA-9	4929			DPR8EIX-9	2202	0.9
	VF750CP-S		CR8EH-9	5666			CR8EHIX-9	3797	0.9
	VFR750F G, F, K	86→88	DPR9EA-9	5329			DPR9EIX-9	5545	0.9
	VFR750F L-V	89→97	CR8EH-9	5666			CR8EHIX-9	3797	0.9
	VFR750R-K/L (RC30)	88→92	CR9EH-9	7502			CR9EHIX-9	6216	0.9
	VT750C2 VT750 V/W Shadow	97→00	DPR8EA-9	4929			DPR8EIX-9	2202	0.8
	VT750DC Shadow	01→06	DPR8EA-9	4929			DPR8EIX-9	2202	0.8
	VT750C NEC Shadow Spirit	07→09	DPR7EA-9	5129			DPR7EIX-9	7803	0.9
	VT750DC Shadow Spirit	07→09	DPR7EA-9	5129			DPR7EIX-9	7803	0.9
	VT750C Shadow Black Spirit	10→	DPR7EA-9	5129			DPR7EIX-9	7803	0.9
	VT750S	10→	DPR7EA-9	5129			DPR7EIX-9	7803	0.9
	XRV750L V, W, X, Y (Africa Twin)	90→03	DPR8EA-9	4929			DPR8EIX-9	2202	0.9
	800	VFR800F-W Fi X-Y (781cc)	97→01	CR9EH-9	7502			CR9EHIX-9	6216
VFR800F-W K2→ Fi VTEC (Incl. ABS) (782cc)		02→					IMR9B-9H	4888	0.9
VFR800X Crossrunner (782cc)		05/11→					IMR9D-9H	6544	0.9
900	CB900F/F2 (Z, D, 2-D)	79→85	DR8ES	5423			DR9EIX	4772	0.7
	CB900F Hornet	02→08	CR8EH-9	5666			CR8EHIX-9	3797	0.9
	CBR900RR-N-S Fireblade (893cc)	92→95	CR9EH-9	7502			CR9EHIX-9	6216	0.9
	CBR900RR T, V, W, X Fireblade (918cc)	96→99	CR9EH-9	7502			CR9EHIX-9	6216	0.9
	CBR900RR Y Fireblade (929cc Injection Model)	00→01					CR9EH-9	6419	0.9
	CBR900RR K2 Fireblade (954cc '02 model)	02→03					IMR9C-9H	6777	0.9
1000	CB1000 F-V	92→97	DPR9EA-9	5329			DPR9EIX-9	5545	0.9
	CB1000R/RA	08→17					IMR9E-9HES	7556	0.9
	CB1000R Neo Sports Café	18→					IMR9E-9HES	7556	0.9
	CBF1000 (Incl. ABS)	06→10	CR8EH-9	5666			CR8EHIX-9	3797	0.9
	CBF1000A (Incl. ABS)	10→					IMR8C-9HES	5990	0.9
	CBF1000F (Incl. ABS & GT)	10→					IMR8C-9HES	5990	0.9
	CBR1000FH-FX	87→99	DPR9EA-9	5329			DPR9EIX-9	5545	0.9
	CBR1000RR Fireblade	04→07					IMR9C-9HES	5766	0.9
	CBR1000RR Fireblade (Incl. ABS)	08→13					IMR9E-9HES	7556	0.9
	CBR1000RR Fireblade	14→16					IMR9E-9HES	7556	0.9
	CBR1000RR Fireblade SP	14→16					IMR9E-9HES	7556	0.9
	CRF1000L Africa Twin (Twin Spark)	12/15→					SILMAR8A9S	90992	0.9
	CRF1000L Africa Twin Adventure Sports (Twin Spark)	18→					SILMAR8A9S	90992	0.9
	GL1000 (Gold Wing)	75→79	DR8ES-L	2923	DR8EVX	6354	DR8EIX	6681	0.7
	VF1000F2F Bol d'Or	85→86	DPR9EA-9	5329			DPR9EIX-9	5545	0.9
	VF1000FE	84→85	DPR8EA-9	4929			DPR8EIX-9	2202	0.9
	VF1000FF	85→87	DPR9EA-9	5329			DPR9EIX-9	5545	0.9
	VF1000RE-Standard	84→85	DPR8EA-9	4929			DPR8EIX-9	2202	0.9
	VF1000RE-High Speed	84→85	DPR9EA-9	5329			DPR9EIX-9	5545	0.9
	VF1000RF	85→88	DPR9EA-9	5329			DPR9EIX-9	5545	0.9
	VTR1000 F W-Y (Firestorm)	97→08					DPR9EIX-9	5545	0.9
	VTR1000 SP1	00→01					FR9B1-11	4709	1.1
	VTR1000 SP2	02→07					IFR9H11	6588	1.1
XL1000V-Y (Varadero)	98→02					DPR8EIX-9	2202	0.8	
XL1000V Varadero (Incl. ABS)	03→12					IJR8B9	4873	0.9	
1050	CBX1000B,C (6-cyl.)	78→84	DR8ES-L	2923	DR8EVX	6354	DR8EIX	6681	0.7
	CB1100 (RB,RC,RD) Road Use	82→84	DR8ES	5423			DR9EIX	4772	0.7
1100	CB1100SF-Y (X11)	99→02					CR8EHIX-9	3797	0.9
	CBR1100 XX V-Y (Super Blackbird)	96→00					CR9EHIX-9	6216	0.9
	CBR1100 XX K1 (Super Blackbird)	2001					IMR9A-9H	6966	0.9
	CBR1100 XX K2 (Super Blackbird) 3405930→	02→07					IMR9C-9H	6777	0.9
	GL1100B (Gold Wing)	80→83	DR8ES-L	2923	DR8EVX	6354	DR8EIX	6681	0.7
	ST1100 ABS/TCS/T/V	95→03	CR8EH-9	5666			CR8EHIX-9	3797	0.9
	ST1100/L S-Y (Pan European)	89→03	CR8EH-9	5666			CR8EHIX-9	3797	0.9
1140	CB1100	13→	LMAR8A-9S	6817					0.9
	CB1100EX	14→	LMAR8A-9S	6817					0.9

2 Wheel



CC	MODEL	DATE	STANDARD COPPER CORE	STOCK NUMBER	PLATINUM OR GOLD PALLADIUM	STOCK NUMBER	IRIDIUM	STOCK NUMBER	GAP MM
HONDA (CONTINUED)									
1200	GL1200-EDE/IE/AE/AF/AH (Gold Wing)	84→88	DPR7EA-9	5129			DPR7EIX-9	7803	0.9
1237	VFR1200F/FD	10→					IMR9E-9HES	7556	0.9
	VFR1200X Crosstourer (Incl. Highlander-T)	04/12→					IMR8E-9HES	95397	0.9
1260	CTX1300	14→	CR8EH-9	5666			CR8EHIX-9	3797	0.9
	ST1300 Pan European (Incl. ABS)	02→14	CR7EH-9	3486			CR7EIX	7385	0.9
1300	CB1300 (Incl. ABS)	03→13	DPR8EA-9	4929			DPR8EIX-9	2202	0.9
	CB1300S (Incl. ABS)	05→13	DPR8EA-9	4929			DPR8EIX-9	2202	0.9
	VTX1300, VT1300CX	03→09	DCPR6E	3481					0.9
1500	GL1500 J-L, GL1500 SE M-Y (Gold Wing)	88→01	DPR6EA-9	5531					0.9
	GL1500CT (Gold Wing)	97→00	DPR7EA-9	5129			DPR7EIX-9	7803	0.9
	GL1500C-V-W-(F6C) (Gold Wing)	96→03	DPR7EA-9	5129			DPR7EIX-9	7803	0.9
1800	GL1800 (Gold Wing) (Incl. ABS)	01→17	BKR6E-11	2756			BKR6EIX-11	3764	1.1
	GL1800 F6B (Gold Wing Bagger)	14→17	BKR6E-11	2756			BKR6EIX-11	3764	1.1
	GL1800 F6C (Gold Wing)	14→17	BKR6E-11	2756			BKR6EIX-11	3764	1.1
	GL1800 (Gold Wing) (Incl. ABS)	18→	CR6HSB-9	97276					0.9
	VTX1800/C	01→08					IFR6L11	3678	1.1

HUONIAO									
50	HN50-QT8	07→	C7HSA	4629			CR7HIX	7544	0.7
125	HN125-8	06→	D8EA	2120			DR8EIX	6681	0.7

HUSABERG									
125	TE125	12→					BR9ECMIX	2707	0.6
250	FE250 (19mm Thread Reach)	2013	CR9EKB	2305			CR9EIX	3521	0.8
	FE250 (26.5mm Thread Reach)	14→					LMAR9AI-10	93188	1.0
	TE250	11→	BR7ES	5122			BR7EIX	6664	0.7
300	TE300	11→	BR7ES	5122			BR7EIX	6664	0.7
350	FE350	13→					LMAR9AI-8	97225	0.8
390	FE390	10→					LKAR8AI-9	6706	0.9
400	FE, FS 400E/C	00→	DCPR8E*	4179			DCR8EIX	3606	0.6
450	FE450	09→					LKAR8AI-9	6706	0.9
470	FC, FX 470/6, E	00→	DCPR8E*	4179			DCR8EIX	3606	0.6
510	FE501	13→					LKAR8AI-9	6706	0.9
550	FC550/4/6	00→	DCPR8E*	4179			DCR8EIX	3606	0.6
565	FE570	09→					LKAR8AI-9	6706	0.9
	FS570	10→					LKAR8AI-9	6706	0.9
650	FE, FS, FX 650 Supermoto	00→	DCPR8E*	4179			DCR8EIX	3606	0.6

HUSQVARNA									
50	CR50	11→	BR8ECM	3035			BR8ECMIX	3520	0.7
	Husky Boy Basic	00→04	B8HS	5510			BR8HIX	7001	0.5
	Husky Boy Junior (12.7mm Thread Reach)	99→02	B6HS	4510			BR6HIX	3419	0.5
	Husky Boy Junior (19mm Thread Reach)	03→					BR10EIX	6801	0.6
	Husky Boy Racing	01→	B6HS	4510			BR6HIX	3419	0.5
	Husky Boy Senior (12.7mm Thread Reach)	99→02	B6HS	4510			BR6HIX	3419	0.5
	Husky Boy Senior (19mm Thread Reach)	03→					BR10EIX	6801	0.6
	SM50	02→10	BR9ES	5722			BR9EIX	3981	0.7
	SM50	11→	BR8ECM	3035			BR8ECMIX	3520	0.7
	WRS 50 (Scooter)		B9ES	2611			BR9EIX	3981	0.7
	WSM 50	03→	BR9ES	5722			BR9EIX	3981	0.7
	WXE 50	03→	BR9ES	5722			BR9EIX	3981	0.7
65	CR65	06/11→	BR8ECM	3035			BR8ECMIX	3520	0.6
125	CR125	→91	B9EG	3530			BR9EIX	3981	0.5
	CR125	92→01					BR10EIX	6801	0.5
	CR125	02→05	BR9EG	3230			BR9EIX	3981	0.5
	CR125	10→	BR9EG	3230			BR9EIX	3981	0.6
	SM125/S	98→	BR9EG	3230			BR9EIX	3981	0.5
	SMS4 125	11→	CR8E	1275			CR8EIX	4218	0.7



* Please note DCPR8E 4339 has a removable terminal nut, whereas DCPR8E 4179 has a fixed terminal nut





CC	MODEL	DATE	STANDARD COPPER CORE	STOCK NUMBER	PLATINUM OR GOLD PALLADIUM	STOCK NUMBER	IRIDIUM	STOCK NUMBER	GAP MM
HUSQVARNA (CONTINUED)									
125	TE125 Ø10mm Plug	11→13	CR8E	1275			CR8EIX	4218	0.7
	TE125 Ø14mm Plug	14→					BR9ECMIX	2707	0.6
	TX125	19→					BR9ECMIX	2707	0.6
	WR125	→91	B9EG	3530			BR9EIX	3981	0.5
	WR125	92→					BR10EIX	6801	0.5
	WR125	02→	BR9EG	3230			BR9EIX	3981	0.5
	WRE125	94→97	B10EG	3630			BR10EIX	6801	0.5
	WRE125 (Restricted)	98→04	BR9EG	3230			BR9EIX	3981	0.5
	WRE125 (Restricted)	09→12	BR9EG	3230			BR9EIX	3981	0.6
	WRK125	→89					BR10EIX	6801	0.5
	WSM125	04→	CR7HSA	4549			CR7HIX	7544	0.7
WXE125	04→	CR7HSA	4549			CR7HIX	7544	0.7	
150	TX 150 TPI	20→					GR8DI-12	90908	1.2
240	WR240		B8EG	3430			BR8EIX	5044	0.5
250	CR250	92→00					BR10EIX	6801	0.5
	CR250	01→04	B8EG	3430			BR8EIX	5044	0.5
	CR250	04→	BR8EG	3130			BR8EIX	5044	0.6
	FE250	14→					LMAR9AI-10	93188	1.0
	TC250	02→05	CR8EB	7784			CR8EIX	4218	0.7
	TC250 (4-Stroke) Ø10mm Plug	10→	CR9EB	6955			CR9EIX	3521	0.7
	TC250 (2-Stroke) Ø14mm Plug	14→	BR8ECM	3035			BR8ECMIX	3520	0.6
	TE250	02→	CR8EB	7784			CR8EIX	4218	0.7
	TE250 i.e (4-Stroke) Ø10mm Plug	10→12	CR9EB	6955			CR9EIX	3521	0.7
	TE250 (4-Stroke) Ø10mm Plug	2013					CR9EIA-9	6289	0.9
	TE250 (2-Stroke) Ø14mm Plug	14→17	BR7ES	5122			BR7EIX	6664	0.6
	TE250 (2-Stroke) Ø14mm Plug	18→					ZGR7GI-13G	96760	1.3
	TXC250	10→	CR9EB	6955			CR9EIX	3521	0.7
	WR250	92→01					BR9EIX	3981	0.5
	WR250	02→	BR8EG	3130			BR8EIX	5044	0.6
WRK250	→89					BR10EIX	6801	0.5	
260	WRK260	→89					BR10EIX	6801	0.5
300	TE300 (2-Stroke) Ø14mm Plug	14→17	BR7ES	5122			BR7EIX	6664	0.6
	TE300 (2-Stroke) Ø14mm Plug	18→					ZGR7GI-13G	96760	1.3
	WR300	09→	BR8EG	3130			BR8EIX	5044	0.6
302	TE310 (4-Stroke) Ø10mm Plug	09→10	CR8EB	7784			CR8EIX	4218	0.7
	TE310 (4-Stroke) Ø10mm Plug	11→12	CR9EB	6955			CR9EIX	3521	0.7
	TE310 (4-Stroke) Ø10mm Plug	2013					CR9EIA-9	6289	0.9
350	FE350	14→16					LMAR9AI-8	97225	0.8
	FE350	17→					LMAR9AI-10	93188	1.0
	TE350	90→95	C8E	7471			CR8EIX	4218	0.5
	WR350	92→02					BR9EIX	3981	0.5
360	CR360	92→94					BR8EIX	5044	0.5
	WR360	02→	B8EG	3430			BR8EIX	5044	0.5
390	CR390		B8EG	3430			BR8EIX	5044	0.5
400	SM400	02→05	CR8EB	7784			CR8EIX	4218	0.7
	TE400	01→	CR8EB	7784			CR8EIX	4218	0.7
	WR400		B8EG	3430			BR8EIX	5044	0.5
410	TE410	96→00	C8E	7471			CR8EIX	4218	0.5
	TE410e	99→00	CR7E	4578			CR7EIX	7385	0.6
430	CR430		B8EG	3430			BR8EIX	5044	0.5
	WR430		B8EG	3430			BR8EIX	5044	0.5
435	CR435		B8EG	3430			BR8EIX	5044	0.5
450	FE450	14→					LKAR8AI-9	6706	0.9
	SM450R	03→07	CR8EB	7784			CR8EIX	4218	0.7
	SM450RR	08→	CR9EKB	2305			CR9EIX	3521	0.8
	TC449	11→	CR9EKB	2305			CR9EIX	3521	0.8
	TC450	04→	CR8EB	7784			CR8EIX	4218	0.7
	TE449	11→	CR9EKB	2305			CR9EIX	3521	0.8
	TE450	03→	CR8EB	7784			CR8EIX	4218	0.7
478	SMR511	11→	CR9EKB	2305			CR9EIX	3521	0.8
	TE511	11→	CR9EKB	2305			CR9EIX	3521	0.8
500	CR500		B8EG	3430			BR8EIX	5044	0.5
	WR500		B8EG	3430			BR8EIX	5044	0.5



CC	MODEL	DATE	STANDARD COPPER CORE	STOCK NUMBER	PLATINUM OR GOLD PALLADIUM	STOCK NUMBER	IRIDIUM	STOCK NUMBER	GAP MM
HUSQVARNA (CONTINUED)									
500	TC500 (Air Cooled)	→5/86	D8EA	2120	DR8EVX	6354	DR8EIX	6681	0.5
510	FE501	14→					LKAR8AI-9	6706	0.9
	SM510 R i.e	10→	CR8EB	7784			CR8EIX	4218	0.7
	TC510 (Liquid Cooled)	06/86→90	C7E	5096			CR7EIX	7385	0.5
	TE510 (Air Cooled)	→5/86	D8EA	2120	DR8EVX	6354	DR8EIX	6681	0.5
	TE510 (Liquid Cooled)	06/86→90	C7E	5096			CR7EIX	7385	0.6
	TE510	04→	CR8EB	7784			CR8EIX	4218	0.7
530	SM530RR	09→	CR9EKB	2305			CR9EIX	3521	0.8
570	SM570	01→04	CR7EB	4663			CR7EIX	7385	0.6
	SM570R	02→04	C7E	5096			CR7EIX	7385	0.6
	SM570R 2004 (Competition Plug)	04→	C8E	7471			CR8EIX	4218	0.5
	TC570	01→02	CR7EB	4663			CR7EIX	7385	0.6
	TE570	01→03	CR7EB	4663			CR7EIX	7385	0.6
600	SMS630 i.e	11→	CR8EB	7784			CR8EIX	4218	0.7
	TE630 i.e	11→	CR8EB	7784			CR8EIX	4218	0.7
610	SM610 S (Std. Plug)	98→05	CR7E	4578			CR7EIX	7385	0.6
	SM610 S (Competition Plug)	03→	C8E	7471			CR8EIX	4218	0.5
	SM610	06→	CPR8E	7411			CR8EIX	4218	0.8
	TC610	91→00	C7E	5096			CR7EIX	7385	0.5
	TE610	91→00	C8E	7471			CR8EIX	4218	0.5
	TE610e	98→05	CR7E	4578			CR7EIX	7385	0.6
630	SMR630	04→	R0045Q-10	4216					1.1
650	TR650 Strada (Twin Spark)	10/12→	MAR9A-6J	91321					0.8
	TR650 Terra (Twin Spark)	10/12→	MAR9A-6J	91321					0.8
692	701 Enduro (Twin spark)		Ø10mm Plug Ø12mm Plug	18→			LMAR7DI-10	96956	1.0
							LKAR9BI-10	95371	1.0
900	Nuda 900, 900R	12→	LMAR8C-9	93833					0.9

HYMOTO									
50	HY50		C7HSA	4629			CR7HIX	7544	0.7
	MP DB701 2-Stroke		BPM7A	7321					0.7
70	HY70		C7HSA	4629			CR7HIX	7544	0.7
90	HY90		C7HSA	4629			CR7HIX	7544	0.7
110	HY110		C7HSA	4629			CR7HIX	7544	0.7
125	HY125		C7HSA	4629			CR7HIX	7544	0.7
	HY125S		C7HSA	4629			CR7HIX	7544	0.7

HYOSUNG									
50	SD50, Sense50	99→05	BP6HS	4511			BPR6HIX	4085	0.7
	SF50	99→05	BR8HSA	5539			BPR8HIX	6742	0.7
100	EZ100	99→	BP7HS	5111			BPR7HIX	5944	0.7
110	FX110		C6HSA	3228			CR6HIX	7274	0.7
	Midas DLX 110	99→	C6HSA	3228			CR6HIX	7274	0.7
125	Cruise 1 125	96→	D8EA	2120	DR8EVX	6354	DR8EIX	6681	0.7
	Cruise 2 125	99→	CR8EH-9	5666			CR8EHIX-9	3797	0.9
	GA125 Cruise III	00→	CR8EH-9	5666			CR8EHIX-9	3797	0.9
	GF125	99→	CR8EH-9	5666			CR8EHIX-9	3797	0.9
	Grand Prix 125, GP-Plus	99→	DR8EA	7162	DR8EVX	6354	DR8EIX	6681	0.7
	GT125	03→	CR8E	1275			CR8EIX	4218	0.6
	GT125R	06→	CR8E	1275			CR8EIX	4218	0.6
	GV125 Aquila	00→	CR8E	1275			CR8EIX	4218	0.6
	GV125C	08→	CR8E	1275			CR8EIX	4218	0.8
	HD125 Hyper	04→06	DR8EA	7162	DR8EVX	6354	DR8EIX	6681	0.8
	MS3-125	07→	CR8E	1275			CR8EIX	4218	0.8
	RT125 (SOHC engine)	04→07	CR8EH-9	5666			CR8EHIX-9	3797	0.9
	RT125D (DOHC engine)	07→	CR8E	1275			CR8EIX	4218	0.8
	RX125 (SOHC engine)	00→07	CR8EH-9	5666			CR8EHIX-9	3797	0.9
	RX125D-E (DOHC engine)	07→	CR8E	1275			CR8EIX	4218	0.8
RX125D SM (DOHC engine)	07→	CR8E	1275			CR8EIX	4218	0.8	
XRX125 (SOHC engine)	→07	CR8EH-9	5666			CR8EHIX-9	3797	0.8	



CC	MODEL	DATE	STANDARD COPPER CORE	STOCK NUMBER	PLATINUM OR GOLD PALLADIUM	STOCK NUMBER	IRIDIUM	STOCK NUMBER	GAP MM
HYOSUNG (CONTINUED)									
250	GT250, Comet	03→	CR8E	1275			CR8EIX	4218	0.8
	GT250 EFI, Comet	08→	CR8E	1275			CR8EIX	4218	0.8
	GT250R	06→08	CR8E	1275			CR8EIX	4218	0.8
	GT250R EFI	08→	CR8E	1275			CR8EIX	4218	0.8
	GV250, Aquila	00→	CR8E	1275			CR8EIX	4218	0.8
	GV250 EFI, Aquila	08→	CR8E	1275			CR8EIX	4218	0.8
	MS3-250	07→	CR8E	1275			CR8EIX	4218	0.8
650	GT650, Comet	03→	CR8E	1275			CR8EIX	4218	0.8
	GT650 EFI, Comet	08→	CR8E	1275			CR8EIX	4218	0.8
	GT650N	12→	CR8E	1275			CR8EIX	4218	0.8
	GT650R	06→08	CR8E	1275			CR8EIX	4218	0.8
	GT650R EFI	08→	CR8E	1275			CR8EIX	4218	0.8
	GT650S	06→08	CR8E	1275			CR8EIX	4218	0.8
	GV650, Aquila	06→08	CR8E	1275			CR8EIX	4218	0.8
	GV650 EFI, Aquila	08→	CR8E	1275			CR8EIX	4218	0.8
680	GV700C EFI	10→	CR8E	1275			CR8EIX	4218	0.8

INDIAN									
1130	Scout, Scout Sixty	15→	MR7F	95897					0.8
1850	Dakota 4 - Classic, Highway, 4 si (Carb)		BPR6HS	7022			BPR6HIX	4085	0.6
	Dakota 4 - Classic, Highway, 4 si (Injection)		BPR7HS	6422			BPR7HIX	5944	0.6

ITALJET									
50	Dragster D50 LC (Liquid Cooled)	98→04	BR8HS	4322			BR8HIX	7001	0.6
	Formula 50, 50 A, Formula 50 Williams (Air Cooled)	96→04	BPR6HS	7022			BPR6HIX	4085	0.6
	Formula 50 LC	98→04	BR7HS	4122			BR7HIX	7067	0.6
	Jetset 50 2T	01→04	BR9ES	5722			BR9EIX	3981	0.7
	Torpedo 50/T50	97→04	BPR6HS	7022			BPR6HIX	4085	0.6
	Velocifero 50/V50	96→	BPR6HS	7022			BPR6HIX	4085	0.6
100	Millennium 100	00→04	BR7HS	4122			BR7HIX	7067	0.6
125	Dragster D125LC (2-Stroke Liquid Cooled)	99→04	BR9ES	5722			BR9EIX	3981	0.7
	Formula 125 LC (Liquid Cooled)	97→04	BR7HS	4122			BR7HIX	7067	0.6
	Jetset 125 4T	01→04	CR7E	4578			CR7EIX	7385	0.6
	Millennium (4-Stroke Liquid Cooled)	00→04	CR8E	1275			CR8EIX	4218	0.7
	Torpedo T125 4T		CR8E	1275			CR8EIX	4218	0.6
150	Jetset 150 4T	01→04	CR7E	4578			CR7EIX	7385	0.6
	Millennium 150	00→04	CR7E	4578			CR7EIX	7385	0.6
176	Dragster D180LC (2-Stroke Liquid Cooled)	99→04	BR9ES	5722			BR9EIX	3981	0.7
250	Jupiter 250	01→04	DR8EA	7162	DR8EVX	6354	DR8EIX	6681	0.7

JAWA-CZ									
50	Jawa Economy, Jive, Jazz		B6HS	4510			BR6HIX	3419	0.5
	MJ50, Korado Basic/K'start, Lux		B6HS	4510			BR6HIX	3419	0.5
125	CZ125	→84	B8HS	5510			BR8HIX	7001	0.5
	CZ125 Oilmaster	84→	B8HS	5510			BR8HIX	7001	0.5
175	CZ175	→84	B8HS	5510			BR8HIX	7001	0.5
	CZ175	84→	B8HS	5510			BR8HIX	7001	0.5
180	CZ180	84→	B8HS	5510			BR8HIX	7001	0.5
250	CZ250 Single/DeLuxe	→84	B8HS	5510			BR8HIX	7001	0.5
	CZ250	84→	B8HS	5510			BR8HIX	7001	0.5
350	CZ350	→84	B8HS	5510			BR8HIX	7001	0.5
	CZ350 Classic/Style/Sport/Chopper	84→	B8HS	5510			BR8HIX	7001	0.7
500	Jawa 500R	86→90	D8EA	2120	DR8EVX	6354	DR8EIX	6681	0.5

JIALING									
50	CJ50F/K		BPR6HS	7022			BPR6HIX	4085	0.7
	JD 50, JL 50	97→00	BPR6HSA	4632			BPR6HIX	4085	0.6
	JH 50	95→	C7HSA	4629			CR7HIX	7544	0.7
	LX50		BPR6HSA	4632			BPR6HIX	4085	0.7



CC	MODEL	DATE	STANDARD COPPER CORE	STOCK NUMBER	PLATINUM OR GOLD PALLADIUM	STOCK NUMBER	IRIDIUM	STOCK NUMBER	GAP MM
JIALING (CONTINUED)									
50	QM 50		BPR4HS	7823					0.7
	TA 55		BPR6HSA	4632			BPR6HIX	4085	0.7
70	CJ70		CR7HSA	4549			CR7HIX	7544	0.7
	JD 70, JH 70	94→00	C7HSA	4629			CR7HIX	7544	0.7
90	JH 90	94→96	C6HSA	3228			CR6HIX	7274	0.7
	K 90		BP7HS	5111			BPR7HIX	5944	0.7
100	K100		BP7HS	5111			BPR7HIX	5944	0.7
	QM100		BP7HS	5111			BPR7HIX	5944	0.7
125	JH125	94→02	DR8ES-L	2923	DR8EVX	6354	DR8EIX	6681	0.7
	Sanyang Duke 125		DPR7EA-9	5129			DPR7EIX-9	7803	0.9
	Sanyang Wolf 125		DR8ES-L	2923	DR8EVX	6354	DR8EIX	6681	0.7

JIANSHE									
125	JS125Y Tiger	03→	DR8ES	5423			DR9EIX	4772	0.7

JINLUN									
50	JL50QT	04→	CR7HSA	4549			CR7HIX	7544	0.7
125	Hornet 125	08→	CR7HSA	4549			CR7HIX	7544	0.7
	JL125-11/13	06→	CR7HSA	4549			CR7HIX	7544	0.7
	JL125-C/Y	05→	CR7HSA	4549			CR7HIX	7544	0.7
	JL125T	05→	CR7HSA	4549			CR7HIX	7544	0.7
150	JL150	05→	D8EA	2120	DR8EVX	6354	DR8EIX	6681	0.7
250	JL250	06→	CR7HSA	4549			CR7HIX	7544	0.7

JONWAY									
50	Madness 50		C7HSA	4629			CR7HIX	7544	0.7
125	Adventure	09→	C7HSA	4629			CR7HIX	7544	0.7

KAWASAKI									
50	AE50 A1/A2, AR50 A1/C1-C10	81→97	B6ES	7310					0.7
60	KX60 A, B1-B13	83→97	B9EG	3530			BR9EIX	3981	0.7
	KX60 B14-B17	98→01	BR9EG	3230			BR9EIX	3981	0.5
65	KX65 A1-A6	00→05	BR10EG	3830			BR10EIX	6801	0.7
80	AE80 A, AR80 A	81→82	BP8ES	2912			BPR8EIX	6684	0.7
	AE80 B, AR80 C1-C8	83→93	BPR8ES	3923			BPR8EIX	6684	0.7
	KX80 A, B	79→80	B8EG	3430			BR8EIX	5044	0.5
	KX80 C-R1	81→91	BR9EG	3230			BR9EIX	3981	0.5
	KX80 R2-R7	92→97	R6252K-105	2741					0.7
	KX80 W1, W2	98→99	R6252K-105	2741					0.7
	KX80 W3	00→	R6252K-105	2741					0.7
85	KX85 A1-A5/B1-B5	01→05	R6252K-105	2741					0.7
	KX85 A6F/B6F	06→13	R6252K-105	2741					0.7
	KX85 II	14→	R6252K-105	2741					0.7
90	KM90A	73→80	B7HS	5110			BR7HIX	7067	0.5
100	G7TA	73→76	B8HS	5510			BR8HIX	7001	0.6
	KC100 C1-C4	79→86	B8ES	2411			BR8EIX	5044	0.7
	KE100 A7-A10, B1-B15	78→99	BR8ES	5422			BR8EIX	5044	0.7
	KH100 A1-A4 (KH100EL)	77→81	B8ES	2411			BR8EIX	5044	0.7
	KH100 G2-G8 (KH100EX)	81→93	B8ES	2411			BR8EIX	5044	0.7
	KM100 A1-A4, A6-A7	76→81	B7HS	5110			BR7HIX	7067	0.6
	KX100 A1-A2, B1	89→91	BR9EG	3230			BR9EIX	3981	0.5
	KX100 B2-B7	92→97	R6252K-105	2741					0.7
	KX100 C1-C3	98→00	R6252K-105	2741					0.7
	KX100 D1-D5, D6F-D9F	01→09	R6252K-105	2741					0.7
110	KLX110 A1/A2	02→	CR6HSA	2983			CR6HIX	7274	0.6
	KSR110	03→	CR6HSA	2983			CR6HIX	7274	0.6
125	AR125 A1, A1A, A1B, A2-A7, B1-B8	82→94	BR8ES	5422			BR8EIX	5044	0.7
	BN125 A1-A8 (Eliminator)	98→05	CR7E	4578			CR7EIX	7385	0.7
	BN125 A6F-A7F, A9F (Eliminator)	06→	CR7E	4578			CR7EIX	7385	0.7



CC	MODEL	DATE	STANDARD COPPER CORE	STOCK NUMBER	PLATINUM OR GOLD PALLADIUM	STOCK NUMBER	IRIDIUM	STOCK NUMBER	GAP MM
KAWASAKI (CONTINUED)									
125	BR125 (Z125)	19→	LMAR8G	95627					0.8
	BX125 (Ninja 125)	19→	LMAR8G	95627					0.8
	D-Tracker	10→	CR7HSA	4549			CR7HIX	7544	0.7
	KDX125 A1/A2,B1/B2	90→94	BR8ES	5422			BR8EIX	5044	0.7
	KE125 A3-A6	76→79	B8HS	5510			BR8HIX	7001	0.6
	KE125 A7-A8	80→81	B8ES	2411			BR8EIX	5044	0.7
	KE125 A9-A12	82→87	B9ES	2611			BR8EIX	3981	0.7
	KH125 A/L/K/K4/K7-K9	82→99	BR8ES	5422			BR8EIX	5044	0.7
	KLX125	10→	CR7HSA	4549			CR7HIX	7544	0.7
	KMX125 A1-A5/B1-B12	86→02	BR8ES	5422			BR8EIX	5044	0.7
	KX125 A1-A5	74→79	B9EG	3530			BR9EIX	3981	0.6
	KX125 A6-A7, B1	80→82					BR9EIX	3981	0.6
	KX125 B2, D-G, H1	83→90	BR10EG	3830			BR10EIX	6801	0.6
	KX125 H2	1991	R6252E-105	2396					0.6
	KX125 J1, J2	92→93	R6252K-105	2741					0.7
	KX125 K1-K5, L1-L4	94→02					BR9EIX	3981	0.6
	KX125 M1	2003					BR9EIX	3981	0.6
	KX125 M2-M3	04→05			R6918B-9	2954			0.8
	KX125 M6, M7F	06→					BR9ECMIX	2707	0.8
	SC125 (J125)	16→	CR7E	4578			CR7EIX	7385	0.7
175	KDX175 A1-A2	80→81	B9ES	2611			BR9EIX	3981	0.7
	KDX175 A3, B1-B2	82→83					BR9EIX	3981	0.6
	KE175 B1-B3	76→79	B9HS	5810			BR9HIX	5687	0.6
	KE175 D1	1979	B9ES	2611			BR9EIX	3981	0.6
	KE175 D2-D5	80→84	B7ES	1111			BR7EIX	6664	0.7
200	KDX200 E1-E6	89→94	BR9ES	5722			BR9EIX	3981	0.7
	KDX200 H1-H10	95→04	BR8ES	5422			BR8EIX	5044	0.7
	KMX200 A2-A4	88→90	BR8ES	5422			BR8EIX	5044	0.7
	Z200 A1-A4	77→81	B7ES	1111			BR7EIX	6664	0.7
	Z200 A5-A6	82→88	BR7ES	5122			BR7EIX	6664	0.7
220	KDX220 A4-A7	97→00	BR8ES	5422			BR8EIX	5044	0.7
	KDX220 A8-A12	01→05	BR8ES	5422			BR8EIX	5044	0.7
250	A1 (Samurai)	67→71	B8HS	5510			BR8HIX	7001	0.6
	BR250 (Z250SL)	15→					MR8CI-8	96973	0.8
	BX250 (Ninja 250SL)	15→					MR8CI-8	96973	0.8
	EL250 D4-D5	93→96	CR8HSA	2086			CR8HIX	7669	0.7
	EL250 F2 (EL252)	97→99	CR8HSA	2086			CR8HIX	7669	0.7
	ER250 B1-B3 (Z250T)	83→90	DPR9EA-9	5329			DPR9EIX-9	5545	0.9
	EX250 F2-F8 (GPX250), H1-H2 (ZZ-R250)	88→92	CR8HSA	2086			CR8HIX	7669	0.6
	EX250 F9 (GPX250R)	1995	CR8HSA	2086			CR8HIX	7669	0.6
	EX250 K8F (Ninja 250R)	08→12	CR8E	1275			CR8EIX	4218	0.7
	F11	72→75	B9HS	5810			BR9HIX	5687	0.6
	KDX250 B2-B4, C1-C3	82→85	BR8ES	5422			BR8EIX	5044	0.7
	KDX250 D1-D5, E1-E2	91→95	BR9ES	5722			BR9EIX	3981	0.7
	KH250 B1-B5	76→82	B9HS	5810			BR9HIX	5687	0.6
	KL250 A1-A4	77→83	B7ES	1111			BR7EIX	6664	0.7
	KL250 C1-C2	83→85	BR8ES	5422			BR8EIX	5044	0.7
	KL250 D2-D11, D16 (KLR250)	85→01	DPR9EA-9	5329			DPR9EIX-9	5545	0.9
	KLX250 B1-B2	81→82	BR7ES	5122			BR7EIX	6664	0.7
	KLX250 D1-D2	93→94	CR8E	1275			CR8EIX	4218	0.7
	KLX250 G1	94→97	CR8E	1275			CR8EIX	4218	0.7
	KLX250 T9F, TAF	09→	CR8E	1275			CR8EIX	4218	0.7
	KR250 B1, B2, B3 (KR-1)	89→90	BR9ES	5722			BR9EIX	3981	0.7
	KR250 C2, C3 (KR-1S)	90→92	BR10ES	4832			BR10EIX	6801	0.7
	KX250 A1-A7, B1	75→82	BR9EG	3230			BR9EIX	3981	0.7
	KX250 C1-C2, D1	83→85	BR8EG	3130			BR8EIX	5044	0.6
	KX250 D2, E1, F1, G1, H1-H2	86→91	BR9EG	3230			BR9EIX	3981	0.7
	KX250 K1-K5, L1-L4	94→02					BR8EIX	5044	0.6
	KX250 M1-M2	03→04					BR8EIX	5044	0.6
	KX250 R1, R6F-R7F	05→07					BR8ECMIX	3520	0.6
	KX250 N1-N2 (KX250F 4-Stroke)	04→05	CR8EB	7784			CR8EIX	4218	0.7
	KX250 T6F-XAF (KX250F 4-Stroke)	06→10	CR8E	1275			CR8EIX	4218	0.7
	KX250 YBF Fi (KX250F 4-Stroke)	11→16	CPR8EB-9	6607					0.9



CC	MODEL	DATE	STANDARD COPPER CORE	STOCK NUMBER	PLATINUM OR GOLD PALLADIUM	STOCK NUMBER	IRIDIUM	STOCK NUMBER	GAP MM
KAWASAKI (CONTINUED)									
250	KX252 (KX250F)	17→19	CPR8EB-9	6607					0.9
	KX252 (KX250)	20→					CR9EIB-9	92579	0.9
	S1 A, B, C (Mach 1)	72→75	B9HS	5810			BR9HIX	5687	0.6
	Z250 A1-A3, B1-B2	79→82	DR8ES	5423			DR9EIX	4772	0.6
	Z250 C1-C2, G1-G2 (Z50LTD)	80→83	B7ES	1111			BR7EIX	6664	0.7
300	KLE300 (Versys-X 300)	17→	CR8E	1275			CR8EIX	4218	0.7
	KLX300 A2-A8, B1-B3	97→03	CR8E	1275			CR8EIX	4218	0.7
	ER300 (Z300)	15→	CR8E	1275			CR8EIX	4218	0.7
	EX300 (Ninja 300)	13→	CR8E	1275			CR8EIX	4218	0.7
	SC300 (J300)	14→	CR7E	4578			CR7EIX	7385	0.7
305	EX305 A1 (GPz305)	83→84	DPR9EA-9	5329			DPR9EIX-9	5545	0.9
	EX305 B2-B10 (GPz305)	84→96	DPR9EA-9	5329			DPR9EIX-9	5545	0.9
350	A7 (Avenger)	67→71	B9HS	5810			BR9HIX	5687	0.6
	S2, S2A (Mach II)	72→73	B9HS	5810			BR9HIX	5687	0.6
400	KH400 A3-A5	76→78	B8HS	5510			BR8HIX	7001	0.7
	KX400 A	75→76	B9EG	3530			BR9EIX	3981	0.6
	S3, S3A	74→75	B9HS	5810			BR9HIX	5687	0.7
	EX400 (Ninja 400)	18→	LMAR9G	97476					0.8
	Z400 D3-D4	76→77	B8ES	2411			BR8EIX	5044	0.7
	Z400 B1-B2, G1	78→79	B7ES	1111			BR7EIX	6664	0.7
	Z400 J1-J2	80→81	D8EA	2120	DR8EVX	6354	DR8EIX	6681	0.7
	Z400 J3	82→83	DR8EA	7162	DR8EVX	6354	DR8EIX	6681	0.7
	ZR400 A (A400F)	83→84	DR8ES	5423			DR9EIX	4772	0.7
	ZR400 B1	84→85	DPR9EA-9	5329			DPR9EIX-9	5545	0.9
	ZX400 C2-C3	85→87	DPR9EA-9	5329			DPR9EIX-9	5545	0.9
	ZX400 L1-L9 (ZXR400)	91→99	CR9EK	4548			CR9EIX	3521	0.7
	420	KX420A	80→81	B9EG	3530			BR9EIX	3981
440	Z440 A2-A3 (LTD), C1-C2	80→82	BR7ES	5122			BR7EIX	6664	0.6
	Z440 H1-H2, D4-D6 (LTD Belt Drive)	82→84	BR7ES	5122			BR7EIX	6664	0.6
450	EN450 A1-A5 (LTD Belt Drive)	85→90	DR8ES	5423			DR9EIX	4772	0.7
	KLX450 A8F	07→	CPR8EB-9	6607					0.9
	KX450 D6F	06→08	CPR8EB-9	6607					0.9
	KX450F	09→18	CPR8EB-9	6607					0.9
	KX450	19→	CPR8EB-9	6607					0.9
500	EN500 A1-A3	90→93	DR8ES	5423			DR9EIX	4772	0.7
	EN500 B2	94→	DR9EA	3437			DR9EIX	4772	0.7
	EN500 C1	96→99	DR9EA	3437			DR9EIX	4772	0.7
	ER500 A1-A4, C3, C4P (ER-5)	97→	DR9EA	3437			DR9EIX	4772	0.7
	ER500 C5P (ER-5)	06→07	DR9EA	3437			DR9EIX	4772	0.7
	EX500 A1-A6 (GPz500S)	87→93	DR8ES	5423			DR9EIX	4772	0.7
	EX500 D1-D3, D5-D7 (GPz500S)	94→00	DR9EA	3437			DR9EIX	4772	0.7
	EX500 E10	02→04	DR9EA	3437			DR9EIX	4772	0.7
	H1 (Mach III), H1A-H1F, KH500A8	69→76	B9HS-10	3626			BR9HIX	5687	1.0
	KLE500 A1-A13	91→03	DR9EA	3437			DR9EIX	4772	0.7
	KLE500 B6F, B7F	05→	DR9EA	3437			DR9EIX	4772	0.7
	KX500 A1-A2	83→84	BR9EG	3230			BR9EIX	3981	0.6
	KX500 B, C, D, E1-E16	85→04	BR8EG	3130			BR8EIX	5044	0.5
	Z500 B1-B4	79→82	D8EA	2120	DR8EVX	6354	DR8EIX	6681	0.7
	550	Z550 A1-A3	80→83	DR8ES	5423			DR9EIX	4772
Z550 C1-C2 (LTD)		81→83	D8EA	2120	DR8EVX	6354	DR8EIX	6681	0.7
Z550 D1 (GPz550)		81→82	D8EA	2120	DR8EVX	6354	DR8EIX	6681	0.7
Z550 G1-G9 (GT550)		83→01	DR8ES	5423			DR9EIX	4772	0.7
Z550 H1-H2 (GPz550), ZR550 A1 (Z550F)		82→85	DR8ES	5423			DR9EIX	4772	0.7
ZR550 B2-B6 (Zephyr 550)		91→98	DR9EA	3437			DR9EIX	4772	0.6
ZX550 A2-A4 (GPz550)		85→91	DPR9EA-9	5329			DPR9EIX-9	5545	0.9
600	KL600 A1	84→85	D8EA	2120	DR8EVX	6354	DR8EIX	6681	0.7
	KL600 B1-B2, B4	85→90	DPR8EA-9	4929			DPR8EIX-9	2202	0.9
	ZL600 B1 (Eliminator 600)	95→97	DR9EA	3437			DR9EIX	4772	0.7
	ZX600 A1-A5 (GPz600R)	85→90	DR9EA	3437			DR9EIX	4772	0.7
	ZX600 C1-C7 (GPz600R)	88→96	DR9EA	3437			DR9EIX	4772	0.7
	ZX600 D1-D3, E1-E12 (ZZ-R600)	90→04	CR9E	6263			CR9EIX	3521	0.7
	ZX600 E6F (ZZR600)	06→	CR9E	6263			CR9EIX	3521	0.7
	ZX600 F1-F3 (Ninja ZX6R)	95→97	CR9E	6263			CR9EIX	3521	0.7



CC	MODEL	DATE	STANDARD COPPER CORE	STOCK NUMBER	PLATINUM OR GOLD PALLADIUM	STOCK NUMBER	IRIDIUM	STOCK NUMBER	GAP MM
KAWASAKI (CONTINUED)									
600	ZX600 G1-G2 (ZX-6R)	98→99	CR9E	6263			CR9EIX	3521	0.7
	ZX600 J1-J2 (ZX-6R)	00→01	CR9E	6263			CR9EIX	3521	0.7
	ZX600 K1H-N6F (Ninja ZX-6RR)	03→06	CR9E	6263			CR9EIX	3521	0.7
	ZX600 P7F-P8F, R9F-RCF (Ninja ZX-6R)	07→	CR9E	6263			CR9EIX	3521	0.7
636	ZX636 A1P, B1H-B2H (Ninja ZX-6R)	02→04	CR9E	6263			CR9EIX	3521	0.7
	ZX636 C1H-C6F (Ninja ZX-6R)	05→06	CR9E	6263			CR9EIX	3521	0.7
	ZX636 (Ninja ZX-6R 636)	13→	CR9E	6263			CR9EIX	3521	0.7
650	EJ650 A1-A2, C1, C5, C6P (W650)	99→05	CR8E	1275			CR8EIX	4218	0.7
	EN650 (Vulcan S)	15→					CR9EIA-9	6289	0.9
	ER650 A7F-C9F (ER-6n)	06→16					CR9EIA-9	6289	0.9
	ER650 (Z650)	17→					CR9EIA-9	6289	0.9
	EX650 A7F-A8F, B7F-B8F (ER-6f)	06→16					CR9EIA-9	6289	0.9
	EX650 KHf (Ninja 650)	17→					CR9EIA-9	6289	0.9
	KL650 A1-A3	87→90	DPR8EA-9	4929			DPR8EIX-9	2202	0.9
	KL650 B1-B3 (Tengai)	89→92	DPR8EA-9	4929			DPR8EIX-9	2202	0.9
	KL650 C1-C5 (KLR 650)	94→02	DPR8EA-9	4929			DPR8EIX-9	2202	0.9
	KLE650 A7F-FGF (Versys)	07→					CR9EIA-9	6289	0.9
	KLX650 C1-C2	93→96	DPR8EA-9	4929			DPR8EIX-9	2202	0.9
	W650 (EJ650 A1-A2, C1, C5, C6P)	99→05	CR8E	1275			CR8EIX	4218	0.7
	Z650 B1-B3, C2-C3 (Custom)	77→79	B7ES	1111			BR7EIX	6664	0.7
	Z650 D2-D3 (SR)	79→82	B7ES	1111			BR7EIX	6664	0.7
	Z650 F1-F4	82→84	B7ES	1111			BR7EIX	6664	0.7
750	H2 (Mach IV), H2A, H2B, H2C	72→75	B9HS-10	3626			BR9HIX	5687	1.0
	VN750 A2-A10 (Vulcan)	86→94	DPR7EA-9	5129			DPR7EIX-9	7803	0.9
	Z750 B1-B2	76→77	B8ES	2411			BR8EIX	5044	0.7
	Z750 E1, H1-H2 (LTD), L1-L4	80→85	BR8ES	5422			BR8EIX	5044	0.7
	Z750 P1-P5 (GT750)	82→92	BR8ES	5422			BR8EIX	5044	0.7
	Z750 P7-P9 (GT750)	91→96	DR8ES	5423			DR9EIX	4772	0.6
	Z750 R1 (GP)	82→83	BR8ES	5422			BR8EIX	5044	0.7
	Z750 Y1 (LTD Twin)	82→83	BPR6ES	7822			BPR6EIX	6637	0.7
	ZR750 C1-C4 (Zephyr 750)	91→94	DR8ES	5423			DR9EIX	4772	0.6
	ZR750 C5 (Zephyr 750)	1995	DR9EA	3437			DR9EIX	4772	0.7
	ZR750 D1 (Zephyr 750)	96→99	DR9EA	3437			DR9EIX	4772	0.7
	ZR750 F1-F5 (ZR-7), H1-H3 (ZR-7S)	05/99→03	DR9EA	3437			DR9EIX	4772	0.7
	ZR750 J1H (Z750)	04→	CR9EK	4548			CR9EIX	3521	0.7
	ZR750 J6F (Z750)	05→	CR9EK	4548			CR9EIX	3521	0.7
	ZR750 K6F (Z750s)	06→	CR9EK	4548			CR9EIX	3521	0.7
	ZR750 L7F, L8F, L9F, LAF, M7F, M8F (Z750)	03/07→10	CR9EK	4548			CR9EIX	3521	0.7
	ZR750 N (Z750R)	11→	CR9EK	4548			CR9EIX	3521	0.7
	ZX750 A1-A3, A5 (GPz750)	83→89	BR9ES	5722			BR9EIX	3981	0.7
	ZX750 E1-E2 (Turbo)	83→87					BR9EIX	3981	0.6
	ZX750 F1-F5 (GPX750R)	87→91	DR8ES	5423			DR9EIX	4772	0.7
	ZX750 G2-G3 (GPz750R)	84→87	D8EA	2120	DR8EVX	6354	DR8EIX	6681	0.7
	ZX750 H1-H2 (ZXR750)	89→91	CR9E	6263			CR9EIX	3521	0.7
	ZX750 J1-J2 (ZXR750)	91→93	CR9E	6263			CR9EIX	3521	0.7
	ZX750 M1-M2 (ZXR750R)	92→94	CR9E	6263			CR9EIX	3521	0.7
	ZX750 L3 (ZXR750)	94→96	CR9E	6263			CR9EIX	3521	0.7
	ZX750 N1 (Ninja ZX-7RR)	96→99	CR9E	6263			CR9EIX	3521	0.7
	ZX750 P1-P7 (Ninja ZX-7R)	96→03	CR9E	6263			CR9EIX	3521	0.7
	773	EJ800A (W800 Incl. Café, Street)	11→	CR8E	1275			CR8EIX	4218
800	VN800 A1-3	95→98	CR7E	4578			CR7EIX	7385	0.7
	VN800 B2-B8 (Classic), C1-C2, E1-E2 (Drifter)	96→	CR7E	4578			CR7EIX	7385	0.8
	Z800 (Incl. Sugomi)	14→	CR9EK	4548			CR9EIX	3521	0.7
	Z800E	14→	CR9EK	4548			CR9EIX	3521	0.7
900	VN900 A6F, B7F (Classic)	06→	CPR7EA-9	3901			CR7EIX	7385	0.9
	VN900 C7F (Custom)	07→	CPR7EA-9	3901			CR7EIX	7385	0.9
	Z1, Z1A, Z1B, Z900 A4	73→76	B8ES	2411			BR8EIX	5044	0.7
	ZX900 A1-A8 (GPZ900R)	84→96	DR8ES	5423			DR9EIX	4772	0.7
	ZX900 B1-B4 (ZX9R Ninja)	94→98	CR9EK	4548			CR9EIX	3521	0.7
	ZX900 C1-C2, E1-E2 (ZX9R Ninja)	98→	CR9EK	4548			CR9EIX	3521	0.7
	ZX900 F1/H/P, F2/H/P (ZX9R)	02→04	CR9EK	4548			CR9EIX	3521	0.7
950	Z900 (Incl. Café, Performance, RS)	17→					CR9EIA-9	6289	0.9



CC	MODEL	DATE	STANDARD COPPER CORE	STOCK NUMBER	PLATINUM OR GOLD PALLADIUM	STOCK NUMBER	IRIDIUM	STOCK NUMBER	GAP MM	
KAWASAKI (CONTINUED)										
1000	KL1000	05→	CR8EK	3478			CR8EIX	4218	0.7	
	Z1000 A1-A3, A4 (Mark II), D1 (Z1-R), E1-E2 (ST), H1 (Fi)	77→81	B8ES	2411			BR8EIX	5044	0.7	
	Z1000 J1-J3, R1-R2, K1 (LTD)	81→84	B8ES	2411			BR8EIX	5044	0.7	
	ZG1000 A1-A7 (1000GTR)	86→94	DR8ES	5423			DR9EIX	4772	0.7	
	ZG1000 A9-A14 (1000GTR)	94→99	DR9EA	3437			DR9EIX	4772	0.7	
	ZL1000 A1 (ZL1000)	87→90	DR8ES	5423			DR9EIX	4772	0.7	
	ZR1000 A1H-A3H (Z1000)	03→05	CR9EK	4548			CR9EIX	3521	0.7	
	ZR1000 A6F (Z1000)	06→07	CR9EK	4548			CR9EIX	3521	0.7	
	ZR1000 B7F-B8F, C7F-C8F, DAF (Z1000)	07→09					CR9EIA-9	6289	0.9	
	ZR1000KLFA (Z H2)	20→					SILMAR9E9	95123	0.9	
	ZX1000 A1-A3 (GPZ1000RX)	85→89	DR8ES	5423			DR9EIX	4772	0.7	
	ZX1000 B1-B3 (ZX-10)	88→91	CR9E	6263			CR9EIX	3521	0.7	
	ZX1000 C1H (ZX10R)	04→					CR9EIA-9	6289	0.9	
	ZX1000 D6F-D7F, E8F-JFF (Ninja ZX-10R)	06→15					CR9EIA-9	6289	0.9	
	ZX1000 RGF (Ninja ZX-10R)	16→					SILMAR9B9	95399	0.9	
	ZX1000NF, PF (Ninja H2, H2R)	15→					SILMAR9B9	95399	0.9	
	ZX1002 CJF (Ninja ZX-10R SE)	18→					SILMAR9B9	95399	0.9	
	ZX1002AJF, BJF (Ninja H2 SX, H2 SX SE)	18→					SILMAR9E9	95123	0.9	
	1043	KLZ1000 ACF (Versys 1000)	12→					CR9EIA-9	6289	0.9
		ZR1000 DAF-FGF (Z1000 Incl. Sugomi)	10→					CR9EIA-9	6289	0.9
ZX1000G, H (Z1000SX, Tourer)		11→19					CR9EIA-9	6289	0.9	
ZX1002KLFA (Ninja 1000SX)		20→					CR9EIA-9	6289	0.9	
1100	Z1100 A1-A3 (Shaft drive)	81→85	BR8ES	5422			BR8EIX	5044	0.7	
	Z1100 B1-B2 (GPz1100)	81→83	BR8ES	5422			BR8EIX	5044	0.7	
	Z1100 R1	84→85	BR8ES	5422			BR8EIX	5044	0.7	
	ZR1100 A1-A4 (Zephyr) Twin Spark	92→95	CR9E	6263			CR9EIX	3521	0.7	
	ZR1100 B1 (Zephyr) Twin Spark	96→97	CR9E	6263			CR9EIX	3521	0.7	
	ZR1100 C1-C4 (ZRX 1100)	97→01	CR9EK	4548			CR9EIX	3521	0.7	
	ZX1100 A1-A3 (GPz1100)	83→88	BR8ES	5422			BR8EIX	5044	0.7	
	ZX1100 C1-C3, D1-D9 (ZZ-R1100)	90→01	CR9E	6263			CR9EIX	3521	0.7	
	ZX1100 E1-E5 (GPZ1100)	95→99	CR9EK	4548			CR9EIX	3521	0.7	
ZX1100 F1 (GPZ1100 ABS)	96→98	CR9EK	4548			CR9EIX	3521	0.7		
1200	ZR1200 A1-A4H, B1-B3P (ZRX 1200)	01→05	CR9EK	4548			CR9EIX	3521	0.7	
	ZR1200 A6F (ZRX1200R)	05→	CR9EK	4548			CR9EIX	3521	0.7	
	ZX1200 A1-A2 (ZX-12R)	99→01			CR9EKPA	7785	CR9EIX	3521	0.8	
	ZX1200 B1H-B3H (Ninja ZX-12R)	02→07			CR9EKPA	7785	CR9EIX	3521	0.8	
	ZX1200-C1H/C2H (ZZ-R1200)	02→04	CR9E	6263			CR9EIX	3521	0.7	
1300	Z1300 A1	78→79	BR8ES	5422			BR8EIX	5044	0.7	
	Z1300 A2-A5	80→83	BPR6ES	7822			BPR6EIX	6637	0.7	
	ZG1300 A1-A3 Fuel Injection	84→90	BPR6ES	7822			BPR6EIX	6637	0.7	
1352	ZG1400 A8F-CCF (1400GTR)	07→					CR9EIA-9	6289	0.9	
	ZX1400 A6F-D8F (ZZ-R1400)	06→11					CR9EIA-9	6289	0.9	
1441	ZX1400 ECF (ZZ-R1400)	12→					CR9EIA-9	6289	0.9	
1500	VN1500 B2-B6, C1-C2	88→95	DPR7EA-9	5129			DPR7EIX-9	7803	0.9	
	VN1500 D1-D2 (VN1500 Classic)	96→98	DPR5EA-9	2887					0.9	
	VN1500 E1-E2 (Classic)	98→99	DPR5EA-9	2887					0.8	
	VN1500 G2 (Nomad)	1999	DPR5EA-9	2887					0.8	
	VN1500 J1-J2 Drifter	99→00	DPR6EA-9	5531					0.9	
	VN1500 L1-L4 Fi (Classic Tourer Fi)	99→03	DPR6EA-9	5531					0.9	
	VN1500 N1-N3H	99→04	DPR6EA-9	5531					0.9	
	VN1500 P1H-P2H (Mean Streak)	01→04	DPR6EA-9	5531					0.9	
	VN1500 R1-R2H (Drifter)	01→04	DPR6EA-9	5531					0.9	
1552	VN1600 A1H-A7F Classic	03→07	DPR6EA-9	5531					0.9	
	VN1600 B1H-B7F Mean Streak	04→07	DPR6EA-9	5531					0.9	
	VN1600 D1H-D8F Classic Tourer	05→08	DPR6EA-9	5531					0.9	
1700	VN1700 Classic, Classic Tourer, Voyager	09→					ILZKAR7B11	1654	1.1	
2050	VN2000 A1H-A6F	04→					IZFR6F11	4095	1.1	

KEEWAY

50	Hurricane (2-Stroke) Ø14mm Plug	08→	BPR7HS	6422			BPR7HIX	5944	0.6
	Hurricane (4-Stroke) Ø10mm Plug	08→	C7HSA	4629			CR7HIX	7544	0.7
	Matrix Sport 50	06→	BPR7HS	6422			BPR7HIX	5944	0.6



CC	MODEL	DATE	STANDARD COPPER CORE	STOCK NUMBER	PLATINUM OR GOLD PALLADIUM	STOCK NUMBER	IRIDIUM	STOCK NUMBER	GAP MM
KEEWAY (CONTINUED)									
125	ARN 125	08→	DPR7EA-9	5129			DPR7EIX-9	7803	0.9
	Hacker 125	08→	DPR7EA-9	5129			DPR7EIX-9	7803	0.9
	Speed 125	08→	DPR7EA-9	5129			DPR7EIX-9	7803	0.9
	Superlight 125	08→	DPR7EA-9	5129			DPR7EIX-9	7803	0.9
250	Cruiser	06→	D7EA	7912					0.7

KENOS									
125	125-12B	12/07→	CR8E	1275			CR8EIX	4218	0.7

KREIDLER									
50	Florett (RM, RMS, RMC), GS50	57→	B7HS	5110			BR7HIX	7067	0.5
	MC-5-50		B7HS	5110			BR7HIX	7067	0.5

KSR MOTO									
50	Epico 50	12→	BR8HSA	5539			BPR8HIX	6742	0.7
	Onyx 50	13→	BR8HSA	5539			BPR8HIX	6742	0.7
	Sirion 50	12→	BR8HSA	5539			BPR8HIX	6742	0.7
125	Code 125	12→	DR8EA	7162	DR8EVX	6354	DR8EIX	6681	0.6
	GSR 125	15→	DR8EA	7162	DR8EVX	6354	DR8EIX	6681	0.6
	Soho 125	12→	CR8E	1275			CR8EIX	4218	0.7
	TR 125	12→	CR8E	1275			CR8EIX	4218	0.7
	TW 125	14→	DR8EA	7162	DR8EVX	6354	DR8EIX	6681	0.6
	Vertigo 125	12→	CR7HSA	4549			CR7HIX	7544	0.7
	Worx 125	12→	DR8EA	7162	DR8EVX	6354	DR8EIX	6681	0.6
	Zion 125	12→	CR8E	1275			CR8EIX	4218	0.7

KTM									
50	50 Pro-Junior, Senior (12.7mm Thread Reach)	2000	B8HS	5510			BR8HIX	7001	0.6
	50 Adventure Mini, Junior & Senior (12.7mm Thread Reach)	→02	BR8HS	4322			BR8HIX	7001	0.6
	50 Adventure Mini, Junior & Senior (19mm Thread Reach)	03→08	BR8ECM	3035			BR8ECMIX	3520	0.6
	50 SX Junior/Senior LC (19mm Thread Reach)	2002	BR10EG	3830			BR10EIX	6801	0.6
	50 SX Pro-Junior LC (Beta engine)	2003	BR8ECM	3035			BR8ECMIX	3520	0.6
	50 SX	09→	LR8B	6208			CR8HIX	7669	0.6
60	60 SX	98→				R7436-10	4900	0.6	
65	65 SX	→03	BR10EG	3830			BR10EIX	6801	0.6
	65 SX Beta engine (19mm Thread Reach)	03→07	BR8ECM	3035			BR8ECMIX	3520	0.6
	65 SX KTM engine (12.7mm Thread Reach)	08/08→	LR8B	6208			CR8HIX	7669	0.6
80	Moto-X models with 1/2", 12.7mm Thread Reach	→85					BR8HIX	7001	0.6
	80 MX	1986	B10EG	3630			BR10EIX	6801	0.6
85	85 SX	03→06					BR10ECMIX	3006	0.7
	85 SX	07→					BR9ECMIX	2707	0.6
125	Moto-X models with 1/2", 12.7mm Thread Reach (Not GP)	→85					BR8HIX	7001	0.6
	125 SX	96→97					BR10EIX	6801	0.6
	125 EXC, EGS, SX	98→00			R6918B-8	4492			0.8
	125 EXC, SX	01→07					BR9EIX	3981	0.6
	125 EXC, EXC, SX, Six Days	08→					BR9ECMIX	2707	0.6
	125 GS	1986	B10EG	3630			BR10EIX	6801	0.6
	125 LC/LCPA	→85	B9EG	3530			BR9EIX	3981	0.6
	125 MX	1986	B10EG	3630			BR10EIX	6801	0.6
	125 MX	87/88	B9EG	3530			BR9EIX	3981	0.6
	125 MX	89/90					BR10EIX	6801	0.6
	125 SM		BR8HS	4322			BR8HIX	7001	0.6
	LC125, LC 2 125 (Duke 125)	96→98	BR9ES	5722			BR9EIX	3981	0.6
	SX 125 (2001)	01→					BR9ECMIX	2707	0.6
144	144 SX	08→					BR9ECMIX	2707	0.6
	150 EXC TPI	20→					GR8DI-12	90908	1.2
	150 SX	09→					BR9ECMIX	2707	0.6
175	Moto-X models with 1/2", 12.7mm Thread Reach	→85					BR8HIX	7001	0.6



CC	MODEL	DATE	STANDARD COPPER CORE	STOCK NUMBER	PLATINUM OR GOLD PALLADIUM	STOCK NUMBER	IRIDIUM	STOCK NUMBER	GAP MM
KTM (CONTINUED)									
200	200 Duke	11→	LKAR8A-9	4786			LKAR8AI-9	6706	0.9
	200 EGS, EXC, MXC	98→03	BR8EG	3130			BR8EIX	5044	0.6
	200 EXC, SX	03→05					BR9EIX	3981	0.6
	200 EXC	06→16	BR8EG	3130			BR8EIX	5044	0.6
	200 XC, XC-W	07→10	BR8EG	3130			BR8EIX	5044	0.6
	RC200	15→	LKAR8A-9	4786			LKAR8AI-9	6706	0.9
250	Moto-X models with 1/2", 12.7mm Thread Reach	→85					BR8HIX	7001	0.6
	250 EXC (2-Stroke) Ø14mm Plug	97→02	BR8ECM	3035			BR8ECMIX	3520	0.6
	250 EXC (2-Stroke) Ø14mm Plug	03→17	BR7ES	5122			BR7EIX	6664	0.7
	250 EXC Racing (4-Stroke) Ø10mm Plug	01→02	CR8EK	3478			CR8EIX	4218	0.7
	250 EXC Racing (4-Stroke) Ø12mm Plug	03→06	DCPR8E*	4179			DCR8EIX	3606	0.6
	250 EXC-F Incl. Fi (4-Stroke) Ø10mm Plug (19mm Thread Reach)	07→13	CR9EKB	2305			CR9EIX	3521	0.8
	250 EXC-F Incl. Fi (4-Stroke) Ø10mm Plug (26.5mm Thread Reach)	14→					LMAR9AI-10	93188	1.0
	250 EXC TPI	17→					ZGR7GI-13G	96760	1.3
	250 GS	1986	B10EG	3630			BR10EIX	6801	0.6
	250 LCPA	→85	B10EG	3630			BR10EIX	6801	0.6
	250 MC/GS	→85	B9EG	3530			BR9EIX	3981	0.6
	250 MX	1986	B10EG	3630			BR10EIX	6801	0.6
	250 MX	87/88	B9EG	3530			BR9EIX	3981	0.6
	250 MX	89/90					BR9EIX	3981	0.6
	250 SX	97→	BR8ECM	3035			BR8ECMIX	3520	0.6
	250 SX (2-Stroke) Ø14mm Plug	03→05	BR8ECM	3035			BR8ECMIX	3520	0.6
	250 SX	06→	BR8ECM	3035			BR8ECMIX	3520	0.6
	250 SX-F (4-Stroke) Ø10mm Plug (19mm Thread Reach)	06→12	CR9EKB	2305			CR9EIX	3521	0.8
	250 SX-F (4-Stroke) Ø10mm Plug (26.5mm Thread Reach)	13→					LMAR9AI-8	97225	0.8
	Freeride 250	13→17	BR7ES	5122			BR7EIX	6664	0.7
	Freeride 250-F	18→					LMAR9AI-10	93188	1.0
300	300 EXC	97→02	BR8ECM	3035			BR8ECMIX	3520	0.6
	300 EXC	03→06	BR7ES	5122			BR7EIX	6664	0.7
	300 EXC	07→16	BR7ES	5122			BR7EIX	6664	0.7
	300 EXC TPI	17→					ZGR7GI-13G	96760	1.3
	300 GS	1986	B10EG	3630			BR10EIX	6801	0.6
	300 MXC	97→02	BR8ECM	3035			BR8ECMIX	3520	0.6
	300 MXC	03→	BR7ES	5122			BR7EIX	6664	0.7
	300 XC	06→	BR7ES	5122			BR7EIX	6664	0.7
	350	350 EXC-F, Six Days (4-Stroke)	11→					LMAR9AI-8	97225
350 MX		87→95	B9EG	3530			BR9EIX	3981	0.6
350 SX-F		10→					LMAR9AI-8	97225	0.8
Freeride 350		12→17					LMAR9AI-10	93188	1.0
373	Duke 390	12→	LKAR8A-9	4786			LKAR8AI-9	6706	0.9
	RC390	15→	LKAR8A-9	4786			LKAR8AI-9	6706	0.9
380	380 EXC, 380 SX		BR8ECM	3035			BR8ECMIX	3520	0.6
390	390 GS	→85	B9EG	3530			BR9EIX	3981	0.6
400	Moto-X models with 1/2", 12.7mm Thread Reach	→85	B9HS	5810			BR9HIX	5687	0.7
	400 EGS-E	97→	DR8EA	7162	DR8EVX	6354	DR8EIX	6681	0.6
	400 EXC, MXC, SX Ø10mm Plug	99→02	CR8EK	3478			CR8EIX	4218	0.7
	400 EXC Ø12mm Plug (19mm Thread Reach)	02→08	DCPR8E*	4179			DCR8EIX	3606	0.6
	400 EXC Ø12mm Plug (26.5mm Thread Reach)	09→11					LKAR8AI-9	6706	0.9
	400 LSE		DR8EA	7162	DR8EVX	6354	DR8EIX	6681	0.6
	LC4 400		DR8EA	7162	DR8EVX	6354	DR8EIX	6681	0.7
420	420 AC	→85	B9EG	3530			BR9EIX	3981	0.6
450	450 EXC-F, Six Days	17→19					LMAR9AI-10	93188	1.0
	450 EXC-F, Six Days	20→					LZMAR8BI-10	95680	1.0
	450 EXC Racing, SX Racing (4-Stroke)	03→07	DCPR8E*	4179			DCR8EIX	3606	0.6
	450 EXC-R (26.5mm Thread Reach)	2008	LKAR8A-9	4786			LKAR8AI-9	6706	0.9
	450 EXC-R, Six Days (26.5mm Thread Reach)	09→16					LKAR8AI-9	6706	0.9
	450 RALLY Replica	2014	CR9EKB	2305			CR9EIX	3521	0.8
	450 RALLY Replica	15→17					LKAR8AI-9	6706	0.9
	450 RALLY Replica	19→					LMAR9AI-10	93188	1.0
	450 SMR Ø12mm Plug	04→07	DCPR8E*	4179			DCR8EIX	3606	0.6
	450 SMR Ø10mm Plug	08→12	CR9EKB	2305			CR9EIX	3521	0.8
	450 SMR Ø12mm Plug (26.5mm Thread Reach)	13→14					LKAR8AI-9	6706	0.9



* Please note DCPR8E 4339 has a removable terminal nut, whereas DCPR8E 4179 has a fixed terminal nut





CC	MODEL	DATE	STANDARD COPPER CORE	STOCK NUMBER	PLATINUM OR GOLD PALLADIUM	STOCK NUMBER	IRIDIUM	STOCK NUMBER	GAP MM	
KTM (CONTINUED)										
450	450 SX-F	07→12	CR9EKB	2305			CR9EIX	3521	0.8	
	450 SX-F	13→15					LKAR8AI-9	6706	0.9	
	450 SX-F	16→					LMAR9AI-8	97225	0.8	
480	505 SX-F	07→08	CR9EKB	2305			CR9EIX	3521	0.8	
495	495 AC	→85	B9EG	3530			BR9EIX	3981	0.6	
500	500 MX, 500 MXC	1986	B9EG	3530			BR9EIX	3981	0.6	
	500 MX	87/88	B9EG	3530			BR9EIX	3981	0.6	
	500 MX	89/90					BR9EIX	3981	0.6	
510	500 EXC, Six Days	12→16					LKAR8AI-9	6706	0.9	
	500 EXC-F	17→19					LMAR9AI-10	93188	1.0	
	500 EXC-F, Six Days	20→					LZMAR8BI-10	95680	1.0	
	530 EXC-R	07→08	LKAR8A-9	4786			LKAR8AI-9	6706	0.9	
	530 EXC-R	09→11					LKAR8AI-9	6706	0.9	
520	520 EXC, MXC, SX	99→02	CR8EK	3478			CR8EIX	4218	0.7	
525	525 EXC Racing, MXC, SX	03→07	DCPR8E*	4179			DCR8EIX	3606	0.6	
560	560-4S	→85	D8EA	2120	DR8EVX	6354	DR8EIX	6681	0.6	
600	600-C4S	→85	D8EA	2120	DR8EVX	6354	DR8EIX	6681	0.6	
	600 4S	86→88	D8EA	2120	DR8EVX	6354	DR8EIX	6681	0.6	
	600 EGS-E		DR8EA	7162	DR8EVX	6354	DR8EIX	6681	0.6	
	LC4 640		DR8EA	7162	DR8EVX	6354	DR8EIX	6681	0.7	
620	620 Adventure, 620LSE, 620 Duke	96→	DR8EA	7162	DR8EVX	6354	DR8EIX	6681	0.6	
625	625 Enduro, Super Moto	02→	DPR8EA-9	4929			DPR8EIX-9	2202	0.9	
	625 SMC	03→06	DCPR8E*	4179			DCR8EIX	3606	0.6	
	625 SXC	03→	DCPR8E*	4179			DCR8EIX	3606	0.6	
	640 LC4, Duke, Duke II	03→	DCPR8E*	4179			DCR8EIX	3606	0.6	
	640 Super Moto	02→	DCPR8E*	4179			DCR8EIX	3606	0.6	
	R640 Adventure	03→	DCPR8E*	4179			DCR8EIX	3606	0.6	
	654	660 SMC	03→06	DCPR8E*	4179			DCR8EIX	3606	0.6
690 Duke		07→11					LKAR8AI-9	6706	0.9	
690 Enduro R		09→11					LKAR8AI-9	6706	0.9	
690 LC4 Supermoto / Prestige		07→					LKAR8AI-9	6706	0.9	
690 SMC		08→11					LKAR8AI-9	6706	0.9	
690 SM R		08→11					LKAR8AI-9	6706	0.9	
690	690 Duke R	10→11					LKAR8AI-9	6706	0.9	
	690 Duke, R (Twin spark)		Ø10mm Plug Ø12mm Plug	12→	LMAR7A-9	4908		LKAR8BI9	1553	0.9
	690 Enduro R	12→13					LKAR8AI-9	6706	0.9	
	690 Enduro R (Twin spark)		Ø10mm Plug Ø12mm Plug	14→	LMAR7A-9	4908		LKAR8BI9	1553	0.9
	690 SMC R	12→13					LKAR8AI-9	6706	0.9	
	690 SMC R (Twin spark)		Ø10mm Plug Ø12mm Plug	14→	LMAR7A-9	4908		LKAR8BI9	1553	0.9
	800	790 Adventure, R, Rally	19→					LMAR9AI-10	93188	1.0
790 Duke		18→					LMAR9AI-10	93188	1.0	
890	890 Duke R	20→					LMAR9AI-10	93188	1.0	
950	950 Adventure / Rally	03→05	CR8EK	3478			CR8EIX	4218	0.7	
	950 Supermoto / Super Enduro R	05→08	CR8EK	3478			CR8EIX	4218	0.7	
1000	990 Adventure / Supermoto	06→08	DCPR8E*	4339			DCPR8EIX	6546	0.9	
	990 Adventure / R	09→12					LKAR8BI9	1553	0.9	
	990 SM-R	09→11					KR8DI	4742	0.8	
	990 SM-R	12→13					LKAR8BI9	1553	0.9	
	990 SM-T	09→10					KR8DI	4742	0.8	
	990 SM-T ABS	11→13					LKAR8BI9	1553	0.9	
	990 Super Duke	04→06	DCPR8E*	4339			DCPR8EIX	6546	0.9	
	990 Super Duke (19mm Thread Reach)	07→11					KR8DI	4742	0.8	
	990 Super Duke R (19mm Thread Reach)	2007					KR8DI	4742	0.8	
	990 Super Duke R (26.5mm Thread Reach)	08→11					LKAR8AI-9	6706	0.9	
	990 Super Duke R (19mm Thread Reach)	12→13					KR8DI	4742	0.8	
1050	1050 Adventure (Twin spark)		Ø10mm Plug Ø12mm Plug	15→			LMAR7DI-10	96956	1.0	
							LKAR9BI-10	95371	1.0	
1148	1190 RC8	08→10					LKAR9BI9	6205	0.9	



* Please note DCPR8E 4339 has a removable terminal nut, whereas DCPR8E 4179 has a fixed terminal nut





CC	MODEL		DATE	STANDARD COPPER CORE	STOCK NUMBER	PLATINUM OR GOLD PALLADIUM	STOCK NUMBER	IRIDIUM	STOCK NUMBER	GAP MM
KTM (CONTINUED)										
1195	1190 Adventure, R (Twin spark)	Ø10mm Plug Ø12mm Plug	13→	LMAR7A-9	4908			LKAR9BI9	6205	0.9
	RC8R (Incl. Track model)		09→11					LKAR9BI9	6205	0.9
	RC8R (Incl. Track model) Twin spark	Ø10mm Plug Ø12mm Plug	11→	LMAR7A-9	4908			LKAR9BI9	6205	0.9
1301	1290 Super Adventure (Twin spark)	Ø10mm Plug Ø12mm Plug	15→					LMAR7DI-10 LKAR9BI-10	96956 95371	1.0 1.0
	1290 Super Duke GT, R, S (Twin spark)	Ø10mm Plug Ø12mm Plug	14→	LMAR7A-9	4908			LKAR9BI9	6205	0.9

KYMCO										
50	Agility 50		05→	CR7HSA	4549			CR7HIX	7544	0.7
	Cobra 50			BR8HSA	5539			BPR8HIX	6742	0.6
	Fever 50			BR8HSA	5539			BPR8HIX	6742	0.6
	Filly 50		98→	CR7HSA	4549			CR7HIX	7544	0.7
	Filly LX 50		99→	CR7HSA	4549			CR7HIX	7544	0.7
	Like 50 (2-Stroke)		10→	BR8HSA	5539			BPR8HIX	6742	0.6
	People 50		04→06	BR8HSA	5539			BPR8HIX	6742	0.6
	Scout 50		97→	BR8HSA	5539			BPR8HIX	6742	0.6
	Spacer 50			BR8HSA	5539			BPR8HIX	6742	0.6
	Super 8 50 (2-Stroke) Ø14mm Plug		07→	BR8HSA	5539			BPR8HIX	6742	0.6
	Super 8 50 (4-Stroke) Ø10mm Plug		11→	CR7HSA	4549			CR7HIX	7544	0.7
	Super 9 50 (Liquid Cooled)		99→	BR8HSA	5539			BPR8HIX	6742	0.6
	Super 9 50 (Air Cooled)		01→	BR8HSA	5539			BPR8HIX	6742	0.6
	Super 9 50 (Air Cooled) (Euro 2)		01→	BR8HSA	5539			BPR8HIX	6742	0.6
	Vitality 50 (2-Stroke)		04→	BR8HSA	5539			BPR8HIX	6742	0.6
	Vitality 50 (4-Stroke)			CR7HSA	4549			CR7HIX	7544	0.7
	Yup 50		00→	BR8HSA	5539			BPR8HIX	6742	0.6
	ZX 50			BR8HSA	5539			BPR8HIX	6742	0.6
100	Cobra 100		99→03	BR6HSA	4296			BPR6HIX	4085	0.7
125	Agility 125		05→	CR7HSA	4549			CR7HIX	7544	0.7
	CK125		05→	DR8EA	7162	DR8EVX	6354	DR8EIX	6681	0.7
	Cruiser 125		03→	CR8E	1275			CR8EIX	4218	0.7
	Downtown 125i		13→	CR7E	4578			CR7EIX	7385	0.7
	Ego 125			DPR7EA-9	5129			DPR7EIX-9	7803	0.9
	Heroism 125			C7HSA	4629			CR7HIX	7544	0.7
	Hipster 125 (2 Valve)		01→	DR8EA	7162	DR8EVX	6354	DR8EIX	6681	0.7
	Hipster 125 (4 Valve)			CR8E	1275			CR8EIX	4218	0.7
	Hipster 125 (4 Valve) (Euro 2)			CR8E	1275			CR8EIX	4218	0.7
	Miler 125 (Grand Dink)		03→	DPR7EA-9	5129			DPR7EIX-9	7803	0.9
	Movie XL125		02→	CR7HSA	4549			CR7HIX	7544	0.7
	People One 125i		13→	CR7E	4578			CR7EIX	7385	0.7
	People S 125 (Euro 3)		05→	CR7HSA	4549			CR7HIX	7544	0.7
	Pulsar 125			DR8EA	7162	DR8EVX	6354	DR8EIX	6681	0.7
	Sector 125			DR8EA	7162	DR8EVX	6354	DR8EIX	6681	0.7
	Spacer 125 (Liquid Cooled)			DPR7EA-9	5129			DPR7EIX-9	7803	0.9
	Stryker 125			DR8EA	7162	DR8EVX	6354	DR8EIX	6681	0.7
	Super 8 125 Ø12mm Plug		07→	DPR7EA-9	5129			DPR7EIX-9	7803	0.9
	Super 8 125 (4-Stroke) Ø10mm Plug			CR7HSA	4549			CR7HIX	7544	0.7
Vivio 125			CR7HSA	4549			CR7HIX	7544	0.7	
Yager GT125		08→	DPR7EA-9	5129			DPR7EIX-9	7803	0.9	
Zing 125		97→	DR8EA	7162	DR8EVX	6354	DR8EIX	6681	0.7	
163	Like 200i (4-Stroke)		11→	CR7HSA	4549			CR7HIX	7544	0.7
200	Yager 200i			DPR6EA-9	5531					0.9
250	Dink 250			DPR7EA-9	5129			DPR7EIX-9	7803	0.9
	Ego 250			DPR7EA-9	5129			DPR7EIX-9	7803	0.9
	Grand Dink 250		01→	DPR7EA-9	5129			DPR7EIX-9	7803	0.9
	People 250		05→	DPR7EA-9	5129			DPR7EIX-9	7803	0.9
	Venox 250		03→	CR8E	1275			CR8EIX	4218	0.7
	Xciting 250 (Carb)		→08	DPR7EA-9	5129			DPR7EIX-9	7803	0.9
	Xciting 250i		06→08	DPR6EA-9	5531					0.9
	Xciting 250i, 250Ri		08→	DPR6EA-9	5531					0.9



CC	MODEL	DATE	STANDARD COPPER CORE	STOCK NUMBER	PLATINUM OR GOLD PALLADIUM	STOCK NUMBER	IRIDIUM	STOCK NUMBER	GAP MM
KYMCO (CONTINUED)									
300	Downtown 300i	11→	CR7E	4578			CR7EIX	7385	0.7
400	Xciting 400i	13→	CR7E	4578			CR7EIX	7385	0.7
500	Xciting 500 (Carb)	05→06	CR8E	1275			CR8EIX	4218	0.7
	Xciting 500i	07→	CR7E	4578			CR7EIX	7385	0.7

LAMBRETTA									
125	LI 125, SL125, SI 125	58→	B7ES	1111			BR7EIX	6664	0.5
150	GP 150	76→98	B7ES	1111			BR7EIX	6664	0.5
200	GP 200, SXJet 200, SX200, Links 200	78→	B7ES	1111			BR7EIX	6664	0.5

LAVERDA									
500	500 Alpino S, Montjuic	78→84	D9EA	2420			DR9EIX	4772	0.7
650	650 i.e, Sport, Formula, Ghost, Diamante	94→98	DCPR9E	2641			DCPR9EIX	2316	0.6
	650, GT, GTL, American Eagle	94→98	B9ES	2611			BR9EIX	3981	0.7
668	668, Ghost, Ghost Strike	96→98	DCPR9E	2641			DCPR9EIX	2316	0.6
750	750, GT, GTL, American Eagle		B8ES	2411			BR8EIX	5044	0.7
	750 S, Ghost 750 Strike, Diamante 750, 750 S Formula	97→02	DCPR9E	2641			DCPR9EIX	2316	0.6
	SF, SFL, SF2, SF3, SFC Twins	68→78	B8ES	2411			BR8EIX	5044	0.7
1000	1000EC, 3C(E), 1000 2CL, Jota, Jarama	76→82	B8ES	2411			BR8EIX	5044	0.7
	RGA, RGS	82→87	B8ES	2411			BR8EIX	5044	0.7
	SFC	85→89	B9ES	2611			BR9EIX	3981	0.7
1200	1200, T, Mirage, TS, Jota American	78→83	B8ES	2411			BR8EIX	5044	0.7

LEM									
50	LX 1,2,3,4 Super & Sport 50 (12.7mm Thread Reach)		B7HS	5110			BR7HIX	7067	0.6
	LX4 (19mm Thread Reach)		BR9ES	5722			BR9EIX	3981	0.7

LEXMOTO									
50	Flash ZN50QT-15A		C7HSA	4629			CR7HIX	7544	0.7
	Hunter	17→	CR7HSA	4549			CR7HIX	7544	0.7
	LSM 50	12→	BR8ES	5422			BR8EIX	5044	0.6
	Milano FT50QT-27	07/15→	C7HSA	4629			CR7HIX	7544	0.7
	Tornado SB50QT-16(B08)		C7HSA	4629			CR7HIX	7544	0.7
	Tommy ZN50QT-A		C7HSA	4629			CR7HIX	7544	0.7
	Tommy II ZN50QT-E		C7HSA	4629			CR7HIX	7544	0.7
125	Adrenaline XFLM125GY-2B	05/15→	CR8E	1275			CR8EIX	4218	0.7
	Arizona ZS125-30		D8EA	2120			DR8EIX	6681	0.7
	Arrow HT125-4F		D8EA	2120			DR8EIX	6681	0.7
	Diablo LJ125T-8M	05/15→	CR7HSA	4549			CR7HIX	7544	0.6
	Firenze ZN125T-F		C7HSA	4629			CR7HIX	7544	0.7
	FMS125 ZN125T-7H	15→	CR7HSA	4549			CR7HIX	7544	0.6
	FMX125 WY125T-108	15→	CR7HSA	4549			CR7HIX	7544	0.6
	Gladiator SB125T-23B		C7HSA	4629			CR7HIX	7544	0.7
	Ranger ZS125-50		D8EA	2120			DR8EIX	6681	0.7
	Street DFE125-8A		CR7E	4578			CR7EIX	7385	0.7
	Tommy ZN125T-E		C7HSA	4629			CR7HIX	7544	0.7
	Tornado SB125T-21(B08)		C7HSA	4629			CR7HIX	7544	0.7
	Valencia	12→	C7HSA	4629			CR7HIX	7544	0.7
	Valiant XF125R	07/15→	CR8E	1275			CR8EIX	4218	0.7
	Venom SK125-22	03/15→	CPR6EA-9	6899					0.9
	Vixen HT125-8		D8EA	2120			DR8EIX	6681	0.7
	XTR KS125-23		D8EA	2120			DR8EIX	6681	0.7
	XTR S KS125-24		D8EA	2120			DR8EIX	6681	0.7
	Zoom II SB125T-21(B10)		C7HSA	4629			CR7HIX	7544	0.7



CC	MODEL	DATE	STANDARD COPPER CORE	STOCK NUMBER	PLATINUM OR GOLD PALLADIUM	STOCK NUMBER	IRIDIUM	STOCK NUMBER	GAP MM
LIFAN									
50	Aero 50 (LF50QT-26A) 2-Stroke		BPR7HS	6422			BPR7HIX	5944	0.6
	Aero 50 (LF50QT-26) 4-Stroke		CR7HSA	4549			CR7HIX	7544	0.6
	Echo (LF50QT-8D)		C7HSA	4629			CR7HIX	7544	0.6
	Jet 50		C7HSA	4629			CR7HIX	7544	0.7
110	Wacky 110		C7HSA	4629			CR7HIX	7544	0.7
125	Aero 125		C7HSA	4629			CR7HIX	7544	0.7
	Beat 125 (LF125-9A)		C7HSA	4629			CR7HIX	7544	0.6
	Blaze (LF125-30)		D8EA	2120			DR8EIX	6681	0.7
	Earth Dragon		D8EA	2120			DR8EIX	6681	0.7
	Mirage 125 (LF125-J)		D8EA	2120	DR8EVX	6354	DR8EIX	6681	0.6
	Samurai (LF125-30)		D8EA	2120			DR8EIX	6681	0.7
	Sprint (LF125-30)		D8EA	2120			DR8EIX	6681	0.7

LML									
125	Star CVT Automatica 4-Stroke	06/13→	CR8EH-9	5666			CR8EHIX-9	3797	0.7
	Star Deluxe 2-Stroke		BP8HS	2630			BPR8HIX	6742	0.7
	Star Deluxe 4-Stroke	11/09→	CR8EH-9	5666			CR8EHIX-9	3797	0.7
	Via Toscana 2-Stroke	09→	BP8HS	2630			BPR8HIX	6742	0.7
150	Star Deluxe 2-Stroke		BPR6ES	7822			BPR6EIX	6637	0.7
	Star Deluxe 4-Stroke	11/09→	CR8EH-9	5666			CR8EHIX-9	3797	0.7
200	Star Deluxe 4-Stroke	11→	CR8EH-9	5666			CR8EHIX-9	3797	0.7

MAGNI									
1000	Australia		D9EA	2420			DR9EIX	4772	0.7
	Sfida 1000		BP6ES	7811			BPR6EIX	6637	0.5
	Sfida Ottovalvole						DR9EIX	4772	0.6

MAICO									
Various	Moto-X models with 1/2", 12.7mm Thread Reach						BR9HIX	5687	0.5
	Moto-X models with 3/4", 19mm Thread Reach		B9EG	3530			BR9EIX	3981	0.5

MALAGUTI									
50	Ciak 50	00→02	BR8HS	4322			BR8HIX	7001	0.6
	Crosser	99→01	BPR6HS	7022			BPR6HIX	4085	0.5
	Drakon 50	04→06	BR9ES	5722			BR9EIX	3981	0.7
	F-10 Jetline	96→06	BR7HS	4122			BR7HIX	7067	0.5
	F-12 Dragon	96→	BR7HS	4122			BR7HIX	7067	0.5
	F-12 Phantom	96→06	BR7HS	4122			BR7HIX	7067	0.5
	F-15 Firefox	97→	BR8HS	4322			BR8HIX	7001	0.5
	F-15 GSE Replica		BR8HS	4322			BR8HIX	7001	0.5
	Foggy Replica		BR8HS	4322			BR8HIX	7001	0.5
	RCX10 (50cc Franco Morini)		B7HS	5110			BR7HIX	7067	0.5
	RCX12 (50cc Franco Morini)		B7HS	5110			BR7HIX	7067	0.5
	Wild Attack F12		BR8HS	4322			BR8HIX	7001	0.5
	XSM 50	04→06	BR9ES	5722			BR9EIX	3981	0.7
	XTM 50	04→06	BR9ES	5722			BR9EIX	3981	0.7
	Yesterday 50	98→00	BR8HS	4322			BR8HIX	7001	0.5
	70	F-69 Phantom	97→99	BR7HS	4122			BR7HIX	7067
100	Ciak 100	00→04	BR8HS	4322			BR8HIX	7001	0.6
	F-12 Phantom 100TD	99→03	BR7HS	4122			BR7HIX	7067	0.6
125	Ciak 125	01→04	BR7HS	4122			BR7HIX	7067	0.6
	Madison 125	99→04	CR8E	1275			CR8EIX	4218	0.7
	X3M Motard 125	10→	CR7HSA	4549			CR7HIX	7544	0.6
150	F-18 Warrior	01→	DPR7EA-9	5129			DPR7EIX-9	7803	0.9
250	Madison 250cc	99→04	DPR9EA-9	5329			DPR9EIX-9	5545	0.9
400	Madison K400	02→04	CR9E	6263			CR9EIX	3521	0.7
500	Spidermax 500 GT	04→06	CR7EKB	4455			CR7EIX	7385	0.8



CC	MODEL	DATE	STANDARD COPPER CORE	STOCK NUMBER	PLATINUM OR GOLD PALLADIUM	STOCK NUMBER	IRIDIUM	STOCK NUMBER	GAP MM
MBK									
50	Booster 50 NG	99→02	BR8HS	4322			BR8HIX	7001	0.5
	Flipper 50		BR8HS	4322			BR8HIX	7001	0.5
	Mach-G (Air Cooled)		BR8HS	4322			BR8HIX	7001	0.6
	Mach-G (Liquid Cooled)		BR8HS	4322			BR8HIX	7001	0.6
	Nitro 50	99→	BR8HS	4322			BR8HIX	7001	0.5
	Nitro-Jaguar F1		BR8HS	4322			BR8HIX	7001	0.5
	Ovetto 50	99→	BR7HS	4122			BR7HIX	7067	0.6
	Stunt 50	00→	BR9HS	4522			BR9HIX	5687	0.6
	X-Limit 50 Supermotard, Enduro	05→	BR9ES	5722			BR9EIX	3981	0.7
	X-Power 50	03→	BR9ES	5722			BR9EIX	3981	0.7
100	Nitro 100	01→	BR8HS	4322			BR8HIX	7001	0.5
	Ovetto 100	01→	BR8HS	4322			BR8HIX	7001	0.6
125	Doodo 125	01→	CR8E	1275			CR8EIX	4218	0.7
	Flame X 125		CR7E	4578			CR7EIX	7385	0.8
	Skycruiser 125	06→	CPR9EA-9	2308			CR9EIX	3521	0.9
	Skyliner 125	01→	CR8E	1275			CR8EIX	4218	0.7
	Thunder 125	01→	CR8E	1275			CR8EIX	4218	0.7
260	Kilibre 300	03→	DR8EA	7162	DR8EVX	6354	DR8EIX	6681	0.7

MONTESA									
123	Cota 123		B6ES	7310					0.5
125	MH123 (Honda engine)		BR7ES	5122			BR7EIX	6664	0.7
175	Cota 172		B6ES	7310					0.5
	Cota 200		B6ES	7310					0.5
200	MH200 (Honda engine)		BPR7ES	2023			BPR7EIX	4055	0.5
250	310		BPR7ES	2023			BPR7EIX	4055	0.5
	4Ride	16→	CR6EH-9	2688			CR6EIA-9	7967	0.9
	Cota 242		BP6ES	7811			BPR6EIX	6637	0.5
	Cota 247		B6HS	4510			BR6HIX	3419	0.6
	Cota 248		BP5ES	6511			BPR5EIX	6597	0.5
	Cota 315 (Honda engine)	97→99	BR6ES	4922					0.6
	Cota 4T (Honda engine)	05→07	CR6EH-9	2688			CR6EIA-9	7967	0.9
260	304, 307, 309		BPR5ES	7422			BPR5EIX	6597	0.5
	311		BPR5ES	7422			BPR5EIX	6597	0.5
	314		BR6ES	4922					0.6
	Cota 4RT	08→14	CR6EH-9	2688			CR6EIA-9	7967	0.9
289	Cota 300RR	15→	CR6EH-9	2688			CR6EIA-9	7967	0.9
310	348		BPR5ES	7422			BPR5EIX	6597	0.5
330	330		BPR5ES	7422			BPR5EIX	6597	0.5
350	335		BPR5ES	7422			BPR5EIX	6597	0.5
	Cota 349		BP5ES	6511			BPR5EIX	6597	0.5

MOTO GUZZI									
231	254	77→81	C7HSA	4629			CR7HIX	7544	0.5
350	V35 (Mark II)	84→87	B8ES	2411			BR8EIX	5044	0.5
500	V50 (Mark II & III)	79→86	B8ES	2411			BR8EIX	5044	0.5
650	V65	84→93	B8ES	2411			BR8EIX	5044	0.5
750	Breva 750 i.e.	04→09	BR8ES	5422			BR8EIX	5044	0.6
	Nevada 750 NT/Nevada club (with Digiplex)	90→03	BR8ES	5422			BR8EIX	5044	0.6
	V7 Classic	07/08→12	BR8ES	5422			BR8EIX	5044	0.6
	V7 Café Classic	09→13	BR8ES	5422			BR8EIX	5044	0.6
	V7 Café Racer Ø14mm Plug	11/10→11	BR8ES	5422			BR8EIX	5044	0.6
	V7 Café Racer Ø10mm Plug	12→13	CPR8EB-9	6607					0.9
	V7 Special, Stone Ø10mm Plug	12→13	CPR8EB-9	6607					0.9
	V7 II Racer, Special, Stone, Stormello	14→	CPR8EB-9	6607					0.9
	V7 III Anniversario, Racer, Special, Stone	17→	CPR8EB-9	6607					0.9
	V75	86→88	B8ES	2411			BR8EIX	5044	0.5
850	Le Mans II & III	78→82	BP6ES	7811			BPR6EIX	6637	0.7
	Series V850	82→85	BP6ES	7811			BPR6EIX	6637	0.7
	V9 Bobber	16→	CPR8EB-9	6607					0.9
	V9 Roamer	16→	CPR8EB-9	6607					0.9



CC	MODEL		DATE	STANDARD COPPER CORE	STOCK NUMBER	PLATINUM OR GOLD PALLADIUM	STOCK NUMBER	IRIDIUM	STOCK NUMBER	GAP MM
MOTO GUZZI (CONTINUED)										
940	Bellagio 940 (Twin Spark)	Ø10mm Plug	07→13	BPR6ES	7822	PMR8B	6378	BPR6EIX	6637	0.7
		Ø14mm Plug								0.7
950	Series 1000 (1000SP Mark II & III)		84→93	BP6ES	7811			BPR6EIX	6637	0.7
1000	California III I.E.		87→93	BP7ES	2412			BPR7EIX	4055	0.5
	California III with Digiplex		91→93	BP7ES	2412			BPR7EIX	4055	0.5
	Centauro V10, Centauro Sport/GT		97→00	DR9EA	3437			DR9EIX	4772	0.6
	Daytona 1000		92→98	D9EA	2420			DR9EIX	4772	0.7
	Daytona 1000 RS		96→00	DR9EA	3437			DR9EIX	4772	0.6
	Le Mans IV 1000		82→03/85	BP7ES	2412			BPR7EIX	4055	0.5
	Le Mans V (Le Mans 1000)		85→94	BP7ES	2412			BPR7EIX	4055	0.5
	Quota 1000		92→97	BP7ES	2412			BPR7EIX	4055	0.5
1100	Brevia V 1100 (Twin Spark)	Ø10mm Plug	05→07	BPR6ES	7822	PMR8B	6378	BPR6EIX	6637	0.7
		Ø14mm Plug								0.7
	California 1100 Carb		94→96	BPR6ES	7822			BPR6EIX	6637	0.6
	California 1100 Inj (Inc. EV, Jackal, Special, Stone & Touring)		94→12	BPR6ES	7822			BPR6EIX	6637	0.7
	California Vintage (Twin Spark)	Ø10mm Plug	06→10	BPR6ES	7822	PMR8B	6378	BPR6EIX	6637	0.7
		Ø14mm Plug								0.7
	Griso 1100 (Twin Spark)		05→07	BPR6ES	7822	PMR8B	6378	BPR6EIX	6637	0.7
	Quota 1100 ES		98→01	BPR6ES	7822			BPR6EIX	6637	0.5
	Sport 1100 (Carb)		94→08/96	BP6ES	7811			BPR6EIX	6637	0.7
	Sport 1100 (Injection)		96→99	BPR6ES	7822			BPR6EIX	6637	0.6
	V11 (Twin Spark)	Ø10mm Plug	2005	BPR6ES	7822	PMR8B	6378	BPR6EIX	6637	0.7
		Ø14mm Plug								0.7
	V11 1100cc		01→05	BPR6ES	7822			BPR6EIX	6637	0.6
V11 Le Mans		03→05	BPR6ES	7822			BPR6EIX	6637	0.6	
1150	Brevia V 1200 (Twin Spark)	Ø10mm Plug	08→11	BPR6ES	7822	PMR8B	6378	BPR6EIX	6637	0.7
		Ø14mm Plug								0.7
	Griso 8V		08→13			PMR8B	6378			0.7
	Griso 8V SE		09→13			PMR8B	6378			0.7
	Griso		14→16	CR8EKB	4374			CR8EIX	4218	0.7
	Norge 1200 (Twin Spark)	Ø10mm Plug	06→08	BPR6ES	7822	PMR8B	6378	BPR6EIX	6637	0.7
		Ø14mm Plug								0.7
	Norge 1200 GT 8V		09→15	CR8EKB	4374			CR8EIX	4218	0.7
	Sport 1200 (Twin Spark)	Ø10mm Plug	07→08	BPR6ES	7822	PMR8B	6378	BPR6EIX	6637	0.7
		Ø14mm Plug								0.7
	Sport 1200 4V		09→13			PMR8B	6378			0.7
	Stelvio 1200 4V		08→10			PMR8B	6378			0.7
	Stelvio 1200 8V		11→16	CR8EKB	4374			CR8EIX	4218	0.7
Stelvio 1200 TT (NTX)		09→10			PMR8B	6378			0.7	
Stelvio 1200 8V NTX		11→16	CR8EKB	4374			CR8EIX	4218	0.7	
1225	MGS-01 Corsa		05→07					DCR9EIX	6650	0.6
1380	Audace (Twin Spark)		15→	LMAR8F-9	90894					0.9
	California (Twin Spark)		13→	LMAR8F-9	90894					0.9
	Eldorado (Twin Spark)		15→	LMAR8F-9	90894					0.9
	MGX-21 (Twin Spark)		17→	LMAR8F-9	90894					0.9

MOTO MORINI										
250	250, Sport		80→85	BP7ES	2412			BPR7EIX	4055	0.7
350	350 3½ Sport/Strada		74→84	BP7ES	2412			BPR7EIX	4055	0.7
	Kanguro 350		82→87	BP7ES	2412			BPR7EIX	4055	0.7
500	Excaliber 500/501		86→93	BP8ES	2912			BPR8EIX	6684	0.5
	Maestro		81→	BP7ES	2412			BPR7EIX	4055	0.7
	Sahara 500		81→89	BP7ES	2412			BPR7EIX	4055	0.7
1187	9½		06→	CR9E	6263			CR9EIX	3521	0.7
	Corsaro		06→	CR9E	6263			CR9EIX	3521	0.7



CC	MODEL	DATE	STANDARD COPPER CORE	STOCK NUMBER	PLATINUM OR GOLD PALLADIUM	STOCK NUMBER	IRIDIUM	STOCK NUMBER	GAP MM
MOTO ROMA									
50	Bee 50		BPR7HS	6422			BPR7HIX	5944	0.6
	GoGo 50	02→	BPR7HS	6422			BPR7HIX	5944	0.6
	Grand Prix 50		BPR7HS	6422			BPR7HIX	5944	0.6
	MRX1		B8HS	5510			BR8HIX	7001	0.6
	MRX2		B8HS	5510			BR8HIX	7001	0.6
	MRX2 Sprint	02→	B7HS	5110			BR7HIX	7067	0.6
	MRX3	02→	B6HS	4510			BR6HIX	3419	0.6
	MRX3 Sprint	02→	B7HS	5110			BR7HIX	7067	0.6
	MRX4	03→	BR10ES	4832			BR10EIX	6801	0.7
	Roadrunner 50		BP7HS	5111			BPR7HIX	5944	0.6
	RT 50 (2-Stroke)	02→	BPR7HS	6422			BPR7HIX	5944	0.6
	Scrambler 50		BPR7HS	6422			BPR7HIX	5944	0.6
	Stinger, Stinger II		BPR7HS	6422			BPR7HIX	5944	0.6
	Wasp		BPR7HS	6422			BPR7HIX	5944	0.6
Wasp II		BPR7HS	6422			BPR7HIX	5944	0.6	
90	RT 90 (4-Stroke)	02→	BPR7HS	6422			BPR7HIX	5944	0.6
100	Grand Prix 100		BPR7HS	6422			BPR7HIX	5944	0.6
	Roadrunner 100		BPR7HS	6422			BPR7HIX	5944	0.6
110	GoGo 110	02→	CR7HS	7223			CR7HIX	7544	0.6
125	Grand Prix 125		CR7HS	7223			CR7HIX	7544	0.6
	MRX125	02→03	D8EA	2120	DR8EVX	6354	DR8EIX	6681	0.6
	MRX125B	04→05	CR7HSA	4549			CR7HIX	7544	0.6
	Road Runner 125	02→	C7HSA	4629			CR7HIX	7544	0.6
	SK125	10→	DR8EA	7162	DR8EVX	6354	DR8EIX	6681	0.6
	SMX125		CR7HSA	4549			CR7HIX	7544	0.6
	Virage 125		D8EA	2120	DR8EVX	6354	DR8EIX	6681	0.6

MOTOBECANE									
50	Mobylette	49→83	B5HS	4210					0.4

MOTORHISPANIA									
50	Furia 50, Furia Cross (1/2", 12.7mm Thread Reach)		BPR7HS	6422			BPR7HIX	5944	0.6
	Furia 50, Furia Cross (3/4", 19mm Thread Reach)	99→	BR9ES	5722			BR9EIX	3981	0.6
	RX50	00→	BR9ES	5722			BR9EIX	3981	0.6
	RYZ 50 Cross, Supermoto	02→	BR9ES	5722			BR9EIX	3981	0.6
125	Duna SM125	07→	CR6HSA	2983			CR6HIX	7274	0.7
	Duna SX125	07→	CR6HSA	2983			CR6HIX	7274	0.7
	MH7	10→	CR6HSA	2983			CR6HIX	7274	0.7
	RYZ 125 (Yamaha engine)	05→	CR7HSA	4549			CR7HIX	7544	0.6

MS									
50	Sprite		BP6ES	7811			BPR6EIX	6637	0.7
	Steward		BP6ES	7811			BPR6EIX	6637	0.7

MV AGUSTA									
675	Brutale 675 Trepistone	02/12→	CR9EKB	2305			CR9EIX	3521	0.8
	F3 (Incl. Serie Oro)	11/11→	CR9EKB	2305			CR9EIX	3521	0.8
750	Brutale S	02→06	CR9EKB	2305			CR9EIX	3521	0.8
	F4, F4S 1+1, F4 SPR	99→04	CR9EKB	2305			CR9EIX	3521	0.8
	F4 Senna	02→04	CR9EKB	2305			CR9EIX	3521	0.8
	F4 all models, track/race use only.	99→04	R0045Q-10	4216					1.1
800	Brutale 800	13→					CR9EIB-9	92579	0.9
	Dragster 800	14→					CR9EIB-9	92579	0.9
	F3	13→					CR9EIB-9	92579	0.9
	Rivale 800	13→					CR9EIB-9	92579	0.9
	Turismo Veloce 800	14→					CR9EIB-9	92579	0.9
910	Brutale 910, 910 R, 910 S	05→08	CR9EKB	2305			CR9EIX	3521	0.8
921	Brutale 920	04/11→	CR9EB	6955			CR9EIX	3521	0.7
982	Brutale 989 R	08→09	CR9EB	6955			CR9EIX	3521	0.7



CC	MODEL	DATE	STANDARD COPPER CORE	STOCK NUMBER	PLATINUM OR GOLD PALLADIUM	STOCK NUMBER	IRIDIUM	STOCK NUMBER	GAP MM
MV AGUSTA (CONTINUED)									
1000	Brutale 990 R	09→12	CR9EB	6955			CR9EIX	3521	0.7
	F4 1000 S	04→09	CR9EKB	2305			CR9EIX	3521	0.8
	F4 1000 R (Incl. Senna)	06→09	CR9EB	6955			CR9EIX	3521	0.7
	F4 AGO	04→05	CR9EB	6955			CR9EIX	3521	0.7
	F4 R 312	07→08	CR9EB	6955			CR9EIX	3521	0.7
	F4	10→	CR9EB	6955			CR9EIX	3521	0.7
	F4 R	12→	CR9EB	6955			CR9EIX	3521	0.7
	F4 RR	11→	CR9EB	6955			CR9EIX	3521	0.7
	F4 all models, track/race use only.	04→	R0045Q-10	4216					1.1
1078	Brutale 1078 RR	08→	CR9EB	6955			CR9EIX	3521	0.7
	Brutale 1090 R	12→	CR9EB	6955			CR9EIX	3521	0.7
	Brutale 1090 RR	10→	CR9EB	6955			CR9EIX	3521	0.7
	F4 RR 312	08→09	CR9EB	6955			CR9EIX	3521	0.7

MZ									
50	Moskito 50		BR7HS	4122			BR7HIX	7067	0.7
	Moskito SX 50		BR7HS	4122			BR7HIX	7067	0.9
125	ETZ 125	86→99	B8HS	5510			BR8HIX	7001	0.6
	Moskito 125		C7HSA	4629			CR7HIX	7544	0.6
	RT/SX/SM 125		CR8E	1275			CR8EIX	4218	0.7
	Saxon Sportstar 125		B8HS	5510			BR8HIX	7001	0.7
	TS125	76→86	B8HS	5510			BR8HIX	7001	0.6
150	ETZ 150	86→95	B8HS	5510			BR8HIX	7001	0.6
	TS150	75→86	B8HS	5510			BR8HIX	7001	0.6
250	ETZ 250/251	81→97	B8HS	5510			BR8HIX	7001	0.6
	TS250-1	76→83	B8HS	5510			BR8HIX	7001	0.6
300	ETZ 300/301 Series	87→97	B8HS	5510			BR8HIX	7001	0.6
500	MZ500, 500R	92→96	D8EA	2120	DR8EVX	6354	DR8EIX	6681	0.7
	Saxon (494cc Rotax engine) Country, Silver Star, Tour	93→98	D8EA	2120	DR8EVX	6354	DR8EIX	6681	0.7
650	Baghira, Black Panther, Mastiff, Supermoto	98→	DPR8EA-9	4929			DPR8EIX-9	2202	0.9
659	Skorpion 659 Replica, Sport, Tour, Traveller	94→	DPR8EA-9	4929			DPR8EIX-9	2202	0.9
	Skorpion Cup 659cc		DPR9EA-9	5329			DPR9EIX-9	5545	0.9
1000	1000S, SF, ST	04→	BCPR6ET	2197			BKR6EIX	6418	0.8

NEVAL									
650	Dnepr Classic, Roadster, Phoenix, Soviet, Soviet Knight	78→	B7HS	5110			BR7HIX	7067	0.5
	Ural 650cc	85→	B6HS	4510			BR6HIX	3419	0.6

NIPPONIA									
50	Neon	12→	BPR7HS	6422			BPR7HIX	5944	0.6
125	Brio	12→	CR7HSA	4549			CR7HIX	7544	0.6
	Dion	12→	CR7HSA	4549			CR7HIX	7544	0.6
	Miro	12→	CR7HSA	4549			CR7HIX	7544	0.6

NORTON									
750	Atlas	62→68	BP8ES	2912			BPR8EIX	6684	0.5
	Commando	67→73	BP7ES	2412			BPR7EIX	4055	0.6
850	Commando	73→78	BP7ES	2412			BPR7EIX	4055	0.6
961	Commando SE	10→	CR9EB	6955			CR9EIX	3521	0.8
	Commando Café Racer	11→	CR9EB	6955			CR9EIX	3521	0.8
	Commando Sport	10→	CR9EB	6955			CR9EIX	3521	0.8
Rotary	F1, Commander	88→93	C8E	7471			CR8EIX	4218	0.6

OSSA									
272	TR280i	11→	BPR5ES	7422			BPR5EIX	6597	0.5



CC	MODEL	DATE	STANDARD COPPER CORE	STOCK NUMBER	PLATINUM OR GOLD PALLADIUM	STOCK NUMBER	IRIDIUM	STOCK NUMBER	GAP MM
PEUGEOT									
50	Buxy / Buxy RS 50 (Air Cooled)	95→97	B7HS	5110			BR7HIX	7067	0.6
	Django 50	15→	BR7HS	4122			BR7HIX	7067	0.6
	Elyseo 50 (Air Cooled)	98→	BR7HS	4122			BR7HIX	7067	0.6
	Elystar 50P	02→05	CPR8E	7411			CR8EIX	4218	0.8
	Jet Force 50	03→	CPR8E	7411			CR8EIX	4218	0.8
	Jet Force C-Tech	06→	CR7EB	4663			CR7EIX	7385	0.6
	Jet Force TSDI	05→	CR7EKA	1462			CR7EIX	7385	0.7
	Looxor 50	01→04	BR7HS	4122			BR7HIX	7067	0.6
	Looxor 50 TSDI Inj. (2-Stroke)	02→	CPR8E	7411			CR8EIX	4218	0.8
	Ludix 50 Blaster, Elegance, Snake Ø14mm Plug	04→07	BR7HS	4122			BR7HIX	7067	0.6
	Ludix Blaster Ø10mm Plug	08→	CR7EB	4663			CR7EIX	7385	0.6
	Ludix Blaster RS12 Ø10mm Plug	06→	CR7EB	4663			CR7EIX	7385	0.6
	Metal-X	02→	BR7HS	4122			BR7HIX	7067	0.6
	Speedake 50 (Air Cooled)	95→97	BR7HS	4122			BR7HIX	7067	0.6
	Speedfight 50 (All models Air Cooled)	96→00	BR7HS	4122			BR7HIX	7067	0.6
	Speedfight 50 LCD/P (Liquid Cooled)	96→00	BR7HS	4122			BR7HIX	7067	0.6
	Speedfight 2 50 (Air Cooled)	00→	BR7HS	4122			BR7HIX	7067	0.6
	Speedfight 2 50 (Liquid Cooled)	01→	BR7HS	4122			BR7HIX	7067	0.6
	Speedfight 2 Motorsport 50 LC	07→	BR7HS	4122			BR7HIX	7067	0.6
	Speedfight 3 Air (Air Cooled)	09→	BR7HS	4122			BR7HIX	7067	0.6
	Speedfight 3 Darkside, Iceblade, Liquid, Team (Liquid Cooled)	09→14	CR7EB	4663			CR7EIX	7385	0.6
	Squab (Air Cooled)	96→97	BR7HS	4122			BR7HIX	7067	0.6
	TKR 50	02→	BR7HS	4122			BR7HIX	7067	0.6
	TKR 50 307 WRC	05→	BR7HS	4122			BR7HIX	7067	0.6
	Trekker 50 Road, Off Road	97→04	BR7HS	4122			BR7HIX	7067	0.6
	Tweet 50	12→	CR6HSA	2983			CR6HIX	7274	0.7
	Vivacity 50, Vivacity 50P	99→10	BR7HS	4122			BR7HIX	7067	0.6
	Vivacity 50 Sportline	00→10	BR7HS	4122			BR7HIX	7067	0.6
	Vivacity 3 Sixties	11→	CR6HSA	2983			CR6HIX	7274	0.7
	V-Clic	07→	CR7HSA	4549			CR7HIX	7544	0.6
	XPS 50 Enduro, Trail, Supermotard 50	03→	BR9ES	5722			BR9EIX	3981	0.7
	XR6 50	03→	BR9ES	5722			BR9EIX	3981	0.7
Zenith 50 L, M, LS, N	95→00	BR7HS	4122			BR7HIX	7067	0.6	
100	Elyseo 100	98→	BR8ES	5422			BR8EIX	5044	0.6
	Looxor 100	01→04	BR8ES	5422			BR8EIX	5044	0.6
	Metal X 100	02→	BR8ES	5422			BR8EIX	5044	0.6
	Speedfight 100 (Air Cooled)	97→	BR8ES	5422			BR8EIX	5044	0.6
	Speedfight WRC 206 (Air Cooled)	01→	BR8ES	5422			BR8EIX	5044	0.6
	Speedfight 2	00→08	BR8ES	5422			BR8EIX	5044	0.6
	Trekker 100 (Air Cooled)	97→00	BR8ES	5422			BR8EIX	5044	0.6
	Vivacity 100, Vivacity 100 Sportline	99→08	BR8ES	5422			BR8EIX	5044	0.6
125	Citystar	11→	CR8EB	7784			CR8EIX	4218	0.8
	Django 125	15→	CR7HSA	4549			CR7HIX	7544	0.7
	Elyseo 125 (Liquid Cooled)	99→	CR7E	4578			CR7EIX	7385	0.6
	Elystar 125	02→05	CR7EB	4663			CR7EIX	7385	0.6
	Elystar 125 Injection	05→11	CR7EB	4663			CR7EIX	7385	0.6
	Geopolis Executive 125	07→	CR9EB	6955			CR9EIX	3521	0.6
	Jet Force F.I.	03→	CR7EB	4663			CR7EIX	7385	0.6
	Jet Force EFI Compressor	05→	CR8EK	3478			CR8EIX	4218	0.7
	Looxor 125	02→	CR7EB	4663			CR7EIX	7385	0.6
	Satelis 125	05→10	CR9EB	6955			CR9EIX	3521	0.6
	Satelis 125 Compressor	07→10	CR9EB	6955			CR9EIX	3521	0.6
	Satelis 125 Executive	06→10	CR9EB	6955			CR9EIX	3521	0.6
	Satelis 2 125	15→	CR8EB	7784			CR8EIX	4218	0.8
	Satelis LFE 125i	13→	CR8EB	7784			CR8EIX	4218	0.8
	Speedfight 3	14→	CR7HSA	4549			CR7HIX	7544	0.7
	Sum Up 125	08→	CR7HSA	4549			CR7HIX	7544	0.7
	SV125	91→94	BP6HS	4511			BPR6HIX	4085	0.6
	Tweet 125	10→	CR7HSA	4549			CR7HIX	7544	0.7
	XPS CT125	06→08	CR7HSA	4549			CR7HIX	7544	0.7
	Vivacity 125	10→	CR7HSA	4549			CR7HIX	7544	0.7



CC	MODEL	DATE	STANDARD COPPER CORE	STOCK NUMBER	PLATINUM OR GOLD PALLADIUM	STOCK NUMBER	IRIDIUM	STOCK NUMBER	GAP MM
PEUGEOT (CONTINUED)									
150	Django 150	15→	CR7HSA	4549			CR7HIX	7544	0.7
	Elyseo 150 (Liquid Cooled)	00→02	CR7E	4578			CR7EIX	7385	0.6
	Elystar 150	02→	CR7EB	4663			CR7EIX	7385	0.6
	Looxor 150	02→	CR7EB	4663			CR7EIX	7385	0.6
200	Citystar 200i	16→	CR8EB	7784			CR8EIX	4218	0.8
250	Geopolis Executive 250	07→	CR9EB	6955			CR9EIX	3521	0.6
	Satelis 250	07→	CR9EB	6955			CR9EIX	3521	0.6
300	Satelis 2 300	15→	CR7EKB	4455			CR7EIX	7385	0.8
400	Metropolis 400i LFE	13→	CPR9EB-9	6508			CR9EIX	3521	0.9
	Satelis 2 400	15→	CPR8EB-9	6607					0.9
	Satelis 2 400RS	15→	CPR8EB-9	6607					0.9
500	Satelis 500	08→	CR7EKB	4455			CR7EIX	7385	0.8

PGO									
50	Big Max, Galaxy 50, G-Max, Mega, Tornado	98→	BPR7HS	6422			BPR7HIX	5944	0.6
	Comet 50, PMX Sport 50, Rodoshow 50, T-Rex 50	98→	BPR7HS	6422			BPR7HIX	5944	0.6
	Libra 50	08→	BPR7HS	6422			BPR7HIX	5944	0.6
	Ligero 50	08→	BPR7HS	6422			BPR7HIX	5944	0.6
	PMX Naked 50	07→	BPR7HS	6422			BPR7HIX	5944	0.6
125	G-Max 125	05→	CR7HSA	4549			CR7HIX	7544	0.6
	Libra 125	08→	C7HSA	4629			CR7HIX	7544	0.6
	Ligero 125	08→	C7HSA	4629			CR7HIX	7544	0.6
	T-Rex 125	98→	CR7HSA	4549			CR7HIX	7544	0.6
250	G-Max 250	05→07	DPR7EA-9	5129			DPR7EIX-9	7803	0.7

PIAGGIO / VESPA									
50	50 Special	83→	B6HS	4510			BR6HIX	3419	0.5
	Fly 50 (2-Stroke)	04→	BR9ES	5722			BR9EIX	3981	0.6
	Fly 50 (4-Stroke) 2V Ø10mm Plug	06→13	CR8EB	7784			CR8EIX	4218	0.8
	Fly 50 (4-Stroke) 4V Ø8mm Plug	14→	ER9EH-6N	1673					0.6
	Free 50 (All versions)	93→97	BR9ES	5722			BR9EIX	3981	0.5
	Liberty 50 (2-Stroke)	97→05	BR9ES	5722			BR9EIX	3981	0.5
	Liberty 50 (4-Stroke)	02→05	CR9EB	6955			CR9EIX	3521	0.7
	Liberty 50 (4-Stroke)	06→16	CR8EB	7784			CR8EIX	4218	0.8
	Liberty 50 (i-Get 4-Stroke Euro 4)	17→					MR8BI-8	91360	0.8
	NRG 50, NRG Power DD/DT Ø14mm Plug	97→	BR9ES	5722			BR9EIX	3981	0.6
	NRG mc3 Pure Jet Ø10mm Plug	02→05	CPR8E	7411			CR8EIX	4218	0.8
	NRG mc3 Pure Jet Ø10mm Plug	06→			ZMR7AP	6914			0.8
	PK50S	83→87	B6HS	4510			BR6HIX	3419	0.5
	Primavera 50 (2-Stroke)	13→15	BR9ES	5722			BR9EIX	3981	0.5
	Primavera 50 (4-Stroke)	13→16	ER9EH-6N	1673					0.6
	Primavera 50 (i-Get 4-Stroke Euro 4)	17→					MR8BI-8	91360	0.8
	Sfera 50	91→97	BR9ES	5722			BR9EIX	3981	0.5
	Typhoon 50	93→05	B9ES	2611			BR9EIX	3981	0.5
	Typhoon 50	06→15	BR9ES	5722			BR9EIX	3981	0.5
	Velofax, Quartz, Zip, Zip SP (2-Stroke)	93→	BR9ES	5722			BR9EIX	3981	0.5
	Vespa ET2 (2-Stroke)	97→05	BR9ES	5722			BR9EIX	3981	0.5
	Vespa ET4 50 (4-Stroke)	01→05	CR9EB	6955			CR9EIX	3521	0.6
	Vespa LX50 (2-Stroke)	98→05	BR9ES	5722			BR9EIX	3981	0.6
	Vespa LX50 (2-Stroke)	05→13	BR9ES	5722			BR9EIX	3981	0.6
	Vespa LX50 (4-Stroke) Ø10mm Plug	06→09	CR8EB	7784			CR8EIX	4218	0.8
	Vespa LX50 4V (4-Stroke) Ø8mm Plug	10→	ER9EH-6N	1673					0.6
	Vespa LXV 50 (2-Stroke)	06→	BR9ES	5722			BR9EIX	3981	0.6
	Vespa S 50 (2-Stroke) Ø14mm Plug	07→	BR9ES	5722			BR9EIX	3981	0.6
	Vespa S 50 (4-Stroke) Ø8mm Plug	08→	ER9EH-6N	1673					0.6
	Vespa Zafferano 50	08→09	BR9ES	5722			BR9EIX	3981	0.6
	Zip 50 (2-Stroke)	93→15	BR9ES	5722			BR9EIX	3981	0.7
	Zip 50 (4-Stroke)	02→16	CR8EB	7784			CR8EIX	4218	0.7
Zip 50 (i-Get 4-Stroke Euro 4)	17→					MR8BI-8	91360	0.8	
80	Sfera 80	93→98	BR9ES	5722			BR9EIX	3981	0.5
	Typhoon 80	94→00	B9ES	2611			BR9EIX	3981	0.5



CC	MODEL	DATE	STANDARD COPPER CORE	STOCK NUMBER	PLATINUM OR GOLD PALLADIUM	STOCK NUMBER	IRIDIUM	STOCK NUMBER	GAP MM
PIAGGIO / VESPA (CONTINUED)									
100	Diesis 100	02→03	BR9ES	5722			BR9EIX	3981	0.6
	Fly 100 (4-Stroke)	08→	CR8EB	7784			CR8EIX	4218	0.7
	PK 100 S	83→93	B6HS	4510			BR6HIX	3419	0.5
	Zip 100 (4-Stroke)	06→08	CR9EB	6955			CR9EIX	3521	0.7
125	Ape		BR7HS	4122			BR7HIX	7067	0.7
	B 125 Beverly (Liquid Cooled 4-Stroke)	02→	CR8EB	7784			CR8EIX	4218	0.8
	Carnaby 125	07→	CR8EB	7784			CR8EIX	4218	0.8
	Cosa, Cosa II (125)	90→95	BR9ES	5722			BR9EIX	3981	0.6
	Fly 125 (4-Stroke)	05→13	CR7EB	4663			CR7EIX	7385	0.6
	Fly 125 (4-Stroke) 3V	14→	CR8EB	7784			CR8EIX	4218	0.7
	Hexagon 125	94→98	BR9ES	5722			BR9EIX	3981	0.5
	Hexagon GTX 125	00→02	CR9EB	6955			CR9EIX	3521	0.7
	Hexagon LX 125	98→00	BR9ES	5722			BR9EIX	3981	0.6
	Liberty 125 (4-Stroke)	98→	CR9E	6263			CR9EIX	3521	0.6
	Liberty 125 Leader		CR8EB	7784			CR8EIX	4218	0.7
	Medley 125	16→					LMAR8EI-7	92499	0.7
	MP3 125	06→	CR8EB	7784			CR8EIX	4218	0.8
	P125X		B6HS	4510			BR6HIX	3419	0.5
	Primavera & PK 125		B6HS	4510			BR6HIX	3419	0.5
	Primavera ET3		B7HS	5110			BR7HIX	7067	0.5
	Primavera 3V (4-Stroke)	13→15	CR8EB	7784			CR8EIX	4218	0.8
	Sfera 125 (4-Stroke)	96→98	CR9E	6263			CR9EIX	3521	0.6
	Skipper	93→98	B9ES	2611			BR9EIX	3981	0.5
	Skipper 125 (2-Stroke)	98→01	BR9ES	5722			BR9EIX	3981	0.5
	Skipper ST 125 (4-Stroke)	00→04	CR7EB	4663			CR7EIX	7385	0.6
	Sprint 3V	14→	CR8EB	7784			CR8EIX	4218	0.8
	Typhoon 125	95→03	B9ES	2611			BR9EIX	3981	0.5
	Typhoon 125	10→	CR7EB	4663			CR7EIX	7385	0.6
	Vespa 946	13→	CR8EB	7784			CR8EIX	4218	0.8
	Vespa ET4 125 (4-Stroke)	96→05	CR8EB	7784			CR8EIX	4218	0.8
	Vespa GT 125 Granturismo	03→07	CR8EB	7784			CR8EIX	4218	0.8
	Vespa GT V 125	06→	CR8EB	7784			CR8EIX	4218	0.8
	Vespa GTS 125	07→15	CR8EB	7784			CR8EIX	4218	0.8
	Vespa GTS 125	16→					LMAR8EI-7	92499	0.7
	Vespa GTS 125 Super i.e.	09→15	CR8EKB	4374			CR8EIX	4218	0.7
	Vespa LX 125 (4-Stroke)	05→11	CR7EB	4663			CR7EIX	7385	0.6
	Vespa LX 125 3V (4-Stroke)	12→	CR8EB	7784			CR8EIX	4218	0.8
	Vespa LX V 125	06→	CR7EB	4663			CR7EIX	7385	0.6
	Vespa PX125E (Electric Start)	82→93	BR7HS	4122			BR7HIX	7067	0.5
	Vespa PX125T5, T5 Classic (2-Stroke)	85→99	B9ES	2611			BR9EIX	3981	0.5
	Vespa PX125 (2-Stroke, Euro 1)	00→08	B6HS	4510			BR6HIX	3419	0.5
	Vespa PX125 (2-Stroke, Euro 3)	11→16	BR6HS	3922			BR6HIX	3419	0.6
	Vespa S 125	07→12	CR7EB	4663			CR7EIX	7385	0.6
	Vespa Zafferano 125	08→09	CR7EB	4663			CR7EIX	7385	0.6
	X7 125	2008	CR8EB	7784			CR8EIX	4218	0.6
	X7 125	09→	CR8EKB	4374			CR8EIX	4218	0.7
X8 125	06→08	CR8EB	7784			CR8EIX	4218	0.6	
X9 125 (Piaggio 4-Stroke)	01→07	CR8EB	7784			CR8EIX	4218	0.6	
X10	14→	CR8EKB	4374			CR8EIX	4218	0.7	
Xevo 125 (Incl. Sport)	07→	CR8EB	7784			CR8EIX	4218	0.7	
Zip 125	01→04	CR7EB	4663			CR7EIX	7385	0.6	
150	Cosa 150		BR9ES	5722			BR9EIX	3981	0.6
	Medley 150	16→					LMAR8EI-7	92499	0.7
	Vespa GTS 150	16→					LMAR8EI-7	92499	0.7
	Vespa PX150	83→08	B6HS	4510			BR6HIX	3419	0.5
Vespa PX150 (2-Stroke, Euro 3)	11→16	BR6HS	3922			BR6HIX	3419	0.6	
180	Hexagon 180LXT	98→00	BR9ES	5722			BR9EIX	3981	0.6
190	Ape		BR7HS	4122			BR7HIX	7067	0.7
200	Beverly 200 (4-Stroke)		CR8EB	7784			CR8EIX	4218	0.8
	Cosa 200, P200E		B6ES	7310					0.5
	Cosa II 200	88→98	B7ES	1111			BR7EIX	6664	0.5
	Vespa 200 Rally	72→79	B7ES	1111			BR7EIX	6664	0.5
Vespa GT 200 Granturismo	03→07	CR7EB	4663			CR7EIX	7385	0.6	



CC	MODEL	DATE	STANDARD COPPER CORE	STOCK NUMBER	PLATINUM OR GOLD PALLADIUM	STOCK NUMBER	IRIDIUM	STOCK NUMBER	GAP MM
PIAGGIO / VESPA (CONTINUED)									
200	Vespa PX200	86→97	B7ES	1111			BR7EIX	6664	0.5
	Vespa PX200 E Disc	98→05	BR6ES	4922					0.6
	X8 200	05→	CR7EKB	4455			CR7EIX	7385	0.8
220	Ape		BR7HS	4122			BR7HIX	7067	0.7
250	Hexagon GT 250, GTX 250 (Honda 4-Stroke)	98→01	DPR6EA-9	5531					0.9
	MP3 250	06→			PMR8A	5851	CR8EIX	4218	0.6
	Super Hexagon GTX250	00→	CR9E	6263			CR9EIX	3521	0.7
	Vespa GTS 250i.e.	05→			PMR8A	5851	CR8EIX	4218	0.6
	Vespa GTV 250i.e.	06→			PMR8A	5851	CR8EIX	4218	0.6
	X7 250	08→			PMR8A	5851	CR8EIX	4218	0.6
	X8 250	06→08	CR8EB	7784			CR8EIX	4218	0.6
	X9 250cc (Honda 4-Stroke)	00→03	DPR7EA-9	5129			DPR7EIX-9	7803	0.9
	X9 250cc Evolution (Quasar 4-Stroke + carb)	04→07	CR8EB	7784			CR8EIX	4218	0.6
	XEvo 250	07→			PMR8A	5851	CR8EIX	4218	0.6
300	MP3 300 (Incl. LT)	10→	CR8EKB	4374			CR8EIX	4218	0.7
	Vespa GTS 300 (Incl. Super, Touring)	08→	CR8EKB	4374			CR8EIX	4218	0.7
	Vespa GTV 300	09→15	CR8EKB	4374			CR8EIX	4218	0.7
350	Beverly 350 Sport Touring	12→	CR8EKB	4374			CR8EIX	4218	0.7
	X10	12→	CR7EKB	4455			CR7EIX	7385	0.8
400	MP3 400	07→10	CR7EKB	4455			CR7EIX	7385	0.8
	X8 400	06→08	CR7EKB	4455			CR7EIX	7385	0.8
	Xevo 400	07→	CR7EKB	4455			CR7EIX	7385	0.8
460	B500	03→	CR7EKB	4455			CR7EIX	7385	0.8
	X9 500 (Fuel Injection 4-Stroke)	02→	CR7EKB	4455			CR7EIX	7385	0.8
	X9 500 Evolution (Fuel Injection 4-Stroke)	04→08	CR7EKB	4455			CR7EIX	7385	0.8
500	MP3 500 LT Sport	11→	CR7EKB	4455			CR7EIX	7385	0.8
	X10	14→	CR7EKB	4455			CR7EIX	7385	0.8

PIONEER

125	Nevada 125	08→	D8EA	2120			DR8EIX	6681	0.7
	Torro 125	08→	D8EA	2120			DR8EIX	6681	0.7

PUCH

50	Magnum		B-4H	4110					0.5
	Maxi: 1.0 HP Models		B-4H	4110					0.5
	Maxi: 1.5 HP Models		B5HS	4210					0.5
	Maxi: 2.0 HP Models		B6HS	4510			BR6HIX	3419	0.5
	Monza 50, Ranger 50, X40		B7HS	5110			BR7HIX	7067	0.5

PULSE

50	Evo SM	11→	BR8ES	5422			BR8EIX	5044	0.6
	HT50QT-36 Force 50 (2-valve)		CR7HS	7223			CR7HIX	7544	0.7
	Advert, Ghost		BPR7HS	6422			BPR7HIX	5944	0.6
	Force 50 (2-Stroke)	08→	BPR7HS	6422			BPR7HIX	5944	0.6
	Lightspeed 2 WY50QT-58	08→	CR7HS	7223			CR7HIX	7544	0.7
	Rhythm, Scout		CR7HS	7223			CR7HIX	7544	0.7
125	Adrenaline 125 XF125GY-2B	08→	CR8E	1275			CR8EIX	4218	0.7
	HT125T-9 Vijo 125		D8EA	2120			DR8EIX	6681	0.7
	Lightspeed 2 WY125T-74	12→	CR7HS	7223			CR7HIX	7544	0.7
	LK125GY-2 Rage 125		CR7HS	7223			CR7HIX	7544	0.7
	Phantom ZN125T-32A		CR7HS	7223			CR7HIX	7544	0.7
	Zoom		CR7HSA	4549			CR7HIX	7544	0.6
250	Adrenaline 250 XF250GY	08→	DR8EA	7162			DR8EIX	6681	0.7

REGAL RAPTOR

50	DD50QE-2	03→	CR7HS	7223			CR7HIX	7544	0.7
100	DD100E	03→	CR7HS	7223			CR7HIX	7544	0.7



CC	MODEL	DATE	STANDARD COPPER CORE	STOCK NUMBER	PLATINUM OR GOLD PALLADIUM	STOCK NUMBER	IRIDIUM	STOCK NUMBER	GAP MM
REGENT									
125	Roadster, Deluxe, Sports Tourer, Super RT125		B7HS	5110			BR7HIX	7067	0.6
150	Roadster, Trail, Deluxe	95→97	B7HS	5110			BR7HIX	7067	0.6
175	Roadster, Trail, Deluxe, Sports Tourer, Super RT175	95→97	B7HS	5110			BR7HIX	7067	0.6

RIDERS									
50	Riders Super Cub	11→	CR7HSA	4549			CR7HIX	7544	0.6
110	Riders Super Cub	11→	CR7HSA	4549			CR7HIX	7544	0.6

RIEJU									
50	MRT 50 (Incl. Pro, SM)		BR9ES	5722			BR9EIX	3981	0.6
	MRX 50 (Minarelli engine)	03→	BR9ES	5722			BR9EIX	3981	0.8
	MRX 50 Pro	03→	BR9ES	5722			BR9EIX	3981	0.8
	MX50 (Morini S5 engine)	03→	B6HS	4510			BR6HIX	3419	0.5
	RR50 / Spike / Supermotard / RR50 Castrol	97→	BR9ES	5722			BR9EIX	3981	0.8
	RRX Spike 50 Supermoto	07→	BR8ES	5422			BR8EIX	5044	0.5
	RS1 Evolution	98→04	BR9ES	5722			BR9EIX	3981	0.8
	RS2 50 Matrix (Incl. Pro)	03→	BR9ES	5722			BR9EIX	3981	0.7
	RS2 50 NKD		BR9ES	5722			BR9EIX	3981	0.7
	RS3	11→	BR9ES	5722			BR9EIX	3981	0.7
	RS3 NKD	13→	BR9ES	5722			BR9EIX	3981	0.7
	SMX (Minarelli engine)	03→	BR9ES	5722			BR9EIX	3981	0.8
	SMX Pro 50	04→	BR9ES	5722			BR9EIX	3981	0.7
	Spike 50		BR9ES	5722			BR9EIX	3981	0.7
Tango 50, Tango0! 50	07→	BR9ES	5722			BR9EIX	3981	0.7	
125	Marathon (Endura / Pro / SM)		CR8E	1275			CR8EIX	4218	0.7
	MRX (Yamaha 4-Stroke)	03→	CR7HSA	4549			CR7HIX	7544	0.6
	RS2 125 Matrix	06→	CR7HSA	4549			CR7HIX	7544	0.6
	RS2 125 NKD	06→07	CR7HSA	4549			CR7HIX	7544	0.6
	RS2 125 Pro	07→11	CR7HSA	4549			CR7HIX	7544	0.6
	RS3	11→	CR8E	1275			CR8EIX	4218	0.7
	RS3 NKD	13→	CR8E	1275			CR8EIX	4218	0.7
	SMX (Yamaha 4-Stroke)	03→	CR7HSA	4549			CR7HIX	7544	0.6
	Tango 125	07→	CR7HSA	4549			CR7HIX	7544	0.6
200	Marathon, Marathon Pro	10→	CR8E	1275			CR8EIX	4218	0.7
250	Marathon	10→	CR8E	1275			CR8EIX	4218	0.7
	Tango 250		D8EA	2120			DR8EIX	6681	0.7
450	Marathon	10→	CR8E	1275			CR8EIX	4218	0.7

ROVIGO									
50	Spoletto 50, Tempesta 50	99→	BPR7HS	6422			BPR7HIX	5944	0.6

ROYAL ENFIELD (1980→)									
350	Bullet Classic models	80→	B7HS	5110			BR7HIX	7067	0.5
500	Bullet Classic models	80→08	BR8ES	5422			BR8EIX	5044	0.5
	Bullet Electra X Lean Burn engine models	04→08	BR9ES	5722			BR9EIX	3981	0.8

RTX									
125	Cross C125, Trials T125		B7HS	5110			BR7HIX	7067	0.6
212	Cross C212, Trials T212		B8HS	5510			BR8HIX	7001	0.6

SACHS									
50	Dirty Devil	04→	BP5HS	4111					0.6
	MadAss 50	04→	CR7HSA	4549			CR7HIX	7544	0.6
	Speedjet R	05/09→	BPR7HS	6422			BPR7HIX	5944	0.7
	Speedjet RS	06/11→	BPR7HS	6422			BPR7HIX	5944	0.7
110	Dirty Devil	04→	C7HSA	4629			CR7HIX	7544	0.6



CC	MODEL	DATE	STANDARD COPPER CORE	STOCK NUMBER	PLATINUM OR GOLD PALLADIUM	STOCK NUMBER	IRIDIUM	STOCK NUMBER	GAP MM
SACHS (CONTINUED)									
125	MadAss 125	06→	C7HSA	4629			CR7HIX	7544	0.6
	Roadster 125	00→05	CR6HSA	2983			CR6HIX	7274	0.8
	XTC 125, ZX Enduro 125, ZZ 125 (Ø14mm Plug)	00→01	BR9ES	5722			BR9EIX	3981	0.8
	XTC 125 (Ø10mm Plug) 4-Stroke	02→07	CR8E	1275			CR8EIX	4218	0.7
650	Roadster 650	00→06	CR10E	6264			CR10EIX	6482	0.8
805	B 805	02→	DPR8EA-9	4929			DPR8EIX-9	2202	0.9
	Roadster 800	00→05	DPR8EA-9	4929			DPR8EIX-9	2202	0.9

SCORPA									
70	4-Tricks	06→07	CR7HSA	4549			CR7HIX	7544	0.7
125	125 Twenty	15→	BP5ES	6511			BPR5EIX	6597	0.8
	SR125R	11→	BP5ES	6511			BPR5EIX	6597	0.5
	SY 125 FR	03→09	CR7HSA	4549			CR7HIX	7544	0.7
	TY-S 125F	04→06	CR7HSA	4549			CR7HIX	7544	0.7
	TY 125F	12→	CR6HSA	2983			CR6HIX	7274	0.7
175	SY 175 F	03→09	CR7HSA	4549			CR7HIX	7544	0.7
	TY-S 175 F	03→09	CR7HSA	4549			CR7HIX	7544	0.7
250	SY 250						BPR6EIX	6637	0.7
	SY 250 FR	07→	CR8E	1275			CR8EIX	4218	0.7
	SY 250 Long Ride	06→09			BKR5EVX	2546	BKR5EIX	6341	0.6
	SY 250 Racing	01→09			BKR5EVX	2546	BKR5EIX	6341	0.6
	T-Ride 250F	08→	CR8E	1275			CR8EIX	4218	0.7
	TY 250 / E						BKR6EIX	6418	0.7
272	SR280R	11→	BP5ES	6511			BPR5EIX	6597	0.5
300	294, 295		BP5ES	6511			BPR5EIX	6597	0.5

SHERCO									
50	0.5 Kid	03→	B9ES	2611			BR9EIX	3981	0.6
	Base		BR9ES	5722			BR9EIX	3981	0.7
	Champion Replica 50		BR9ES	5722			BR9EIX	3981	0.7
	Enduro 50	03→	BR9ES	5722			BR9EIX	3981	0.7
	HRD50	03→	BR9ES	5722			BR9EIX	3981	0.7
	Ipone Replica		BR9ES	5722			BR9EIX	3981	0.7
	Supermotard 50	03→	BR9ES	5722			BR9EIX	3981	0.7
80	80 ST	14→	BP5ES	6511			BPR5EIX	6597	0.8
	ST 0.8	04→	BP5ES	6511			BPR5EIX	6597	0.5
125	Academy 125	2009	BP5ES	6511			BPR5EIX	6597	0.6
	City Corp 125	04→	CR7HSA	4549			CR7HIX	7544	0.6
	ST 1.25	99→	BP5ES	6511			BPR5EIX	6597	0.6
	125 SE-R	18→					BR9ECMIX	2707	0.7
	125 ST	14→	BP5ES	6511			BPR5EIX	6597	0.6
200	2.0	99→	BP5ES	6511			BPR5EIX	6597	0.6
250	2.5i-F	08→11	CR8EK	3478			CR8EIX	4218	0.7
	Access 2.5 (2-Stroke)	2010	BP5ES	6511			BPR5EIX	6597	0.6
	SE 250i	12→	CR8EK	3478			CR8EIX	4218	0.7
	ST 2.5	99→10	BP5ES	6511			BPR5EIX	6597	0.6
	ST 2.5	11→13	BP5ES	6511			BPR5EIX	6597	0.6
	250 SE-R	15→	BR8ES	5422			BR8EIX	5044	0.7
	250 ST	14→	BP5ES	6511			BPR5EIX	6597	0.6
272	290 X-Ride	12→	BPR5ES	7422			BPR5EIX	6597	0.6
290	3.0i-F	10→11	CR8EK	3478			CR8EIX	4218	0.7
	Access 2.9 (2-Stroke)	2010	BP5ES	6511			BPR5EIX	6597	0.6
	300 SE-R	15→	BR8ES	5422			BR8EIX	5044	0.7
	SE 300i	12→	CR8EK	3478			CR8EIX	4218	0.7
	ST 2.9	99→10	BP5ES	6511			BPR5EIX	6597	0.6
	ST 2.9	11→	BP5ES	6511			BPR5EIX	6597	0.6
320	3.2 4T	05→			PFR6B	3500		0.6	
450	4.5i-F 4T	04→	CR8EK	3478			CR8EIX	4218	0.7
	4.5i Enduro	05→	CR8EK	3478			CR8EIX	4218	0.7
510	5.1i	05→	CR8EK	3478			CR8EIX	4218	0.7



CC	MODEL	DATE	STANDARD COPPER CORE	STOCK NUMBER	PLATINUM OR GOLD PALLADIUM	STOCK NUMBER	IRIDIUM	STOCK NUMBER	GAP MM
SIMSON									
50	S51 Series SR50		B7HS	5110			BR7HIX	7067	0.5
70	S70 C&E	83→	B7HS	5110			BR7HIX	7067	0.5

SINNIS									
50	Eagle, Hawk (2-Stroke)	06/06→	BPR7HS	6422			BPR7HIX	5944	0.6
	Falcon, Jet (4-Stroke)	06/06→	CR7HSA	4549			CR7HIX	7544	0.6
	Flair	05/12→	CR7HSA	4549			CR7HIX	7544	0.6
	Ghost, Nitro, Pioneer, Strike (2-Stroke)	06/06→09	BPR7HS	6422			BPR7HIX	5944	0.6
	Phoenix	05/12→	BPR7HS	6422			BPR7HIX	5944	0.6
110	Breeze	06/06→09	CR7HSA	4549			CR7HIX	7544	0.6
125	Apache, Blade, Max, Stealth, Vista	12/07→	CR8E	1275			CR8EIX	4218	0.7
	Eagle, Matrix, Matrix II, Nitro, Pioneer, Sublime (4-Stroke)	01/07→	CR7HSA	4549			CR7HIX	7544	0.6
	Eco City	01/10→	CR7HSA	4549			CR7HIX	7544	0.6
	Spirit	05/12→	CR7HSA	4549			CR7HIX	7544	0.6
	Trackstar	05/10→	CR8E	1275			CR8EIX	4218	0.7
200	Apache, Blade	12/07→09	DR8ES-L	2923	DR8EVX	6354	DR8EIX	6681	0.7

SKYTEAM									
125	Wacky ST125/Y		C7HSA	4629			CR7HIX	7544	0.7

SMC									
50	NAF 50 Navigator		BPR7HS	6422			BPR7HIX	5944	0.6
	NGF 50 Sports Force		BPR7HS	6422			BPR7HIX	5944	0.6
	NKF 50 on/off road		BPR7HS	6422			BPR7HIX	5944	0.6
	NLFR 50 Caprillio		BPR7HS	6422			BPR7HIX	5944	0.6
	PAF 50 Partner		BPR7HS	6422			BPR7HIX	5944	0.6
	SBF 50 Super		BPR7HS	6422			BPR7HIX	5944	0.6
90	NGN 90 Sports Force		BPR7HS	6422			BPR7HIX	5944	0.6
	SBN 90 Super		BPR7HS	6422			BPR7HIX	5944	0.6
100	NKO 100 on/off road		BPR7HS	6422			BPR7HIX	5944	0.6
	SBO 100 Super		BPR7HS	6422			BPR7HIX	5944	0.6
125	CHP 125 Chopper		DR8EA	7162	DR8EVX	6354	DR8EIX	6681	0.7

SUPERBYKE									
50	M-PED 50	06→	CR7HSA	4549			CR7HIX	7544	0.6
	Powerband 50 (2-Stroke) Ø14mm Plug	06→	BPR7HS	6422			BPR7HIX	5944	0.6
	Powermax 50 (2-Stroke) Ø14mm Plug	08→	BPR7HS	6422			BPR7HIX	5944	0.6
125	Powerband 125	06→	CR7HSA	4549			CR7HIX	7544	0.6
	RBP125	06→	D8EA	2120			DR8EIX	6681	0.7
	RMR125		CR8E	1275			CR8EIX	4218	0.7
	RSP125	10→	DR8EA	7162			DR8EIX	6681	0.7
	SMax125	08→	CR7HSA	4549			CR7HIX	7544	0.6

SUZUKI									
50	AE50 L, M, N, P, R, T	90→99	BPR6HS	7022			BPR6HIX	4085	0.6
	AH50	93→96	BPR6HS	7022			BPR6HIX	4085	0.6
	AP50 T, V, W	96→02	BPR6HS	7022			BPR6HIX	4085	0.7
	AY50 Katana (Incl. R) Air cooled (Ø14mm Plug)	97→04	BPR6HS	7022			BPR6HIX	4085	0.8
	AY50W, WR Katana (Incl. R) Liquid cooled (Ø14mm Plug)	98→04	BPR6HS	7022			BPR6HIX	4085	0.8
	AY50A Katana (Incl. R) Liquid cooled (Ø10mm Plug)	05→06	CPR8E	7411			CR8EIX	4218	0.8
	CL50D, CS50D Roadie, FS50 Snip	82→88	BPR4HS	7823					0.7
	CP50	85→92	BPR6HS	7022			BPR6HIX	4085	0.6
	DR50	86→94	BR7HS	4122			BR7HIX	7067	0.6
	FR50	81→86	BPR4HS	7823					0.7
	FZ50 Suzy	80→86	BPR4HS	7823					0.7
	JR50	85→06	BPR4HS	7823					0.7
	RM50	78→99	B7HS	5110			BR7HIX	7067	0.6
	RMX 50	96→01	BPR8ES	3923			BPR8EIX	6684	0.7



CC	MODEL	DATE	STANDARD COPPER CORE	STOCK NUMBER	PLATINUM OR GOLD PALLADIUM	STOCK NUMBER	IRIDIUM	STOCK NUMBER	GAP MM
SUZUKI (CONTINUED)									
50	SMX 50	96→02	BPR8ES	3923			BPR8EIX	6684	0.7
	TR50S	97→00	BPR6HS	7022			BPR6HIX	4085	0.6
	TS50	71→78	BP6HS	4511			BPR6HIX	4085	0.6
	TS50ER (1/2", 12.7mm Thread Reach)	79→83	BP6HS	4511			BPR6HIX	4085	0.7
	TS50ER (3/4", 19mm Thread Reach)	79→83	BPR6ES	7822			BPR6EIX	6637	0.7
	TS50X	84→00	BPR6ES	7822			BPR6EIX	6637	0.7
	UF 50 Estilete	99→01	BPR7HS	6422			BPR7HIX	5944	0.6
	UX50W-X-Y Zillion	99→01	BPR6HS	7022			BPR6HIX	4085	0.6
ZR50	83→99	BP6ES	7811			BPR6EIX	6637	0.7	
65	RM65 K3-K5	03→05	B10EG	3630			BR10EIX	6801	0.6
70	DR-Z70	08→	CR7HSA	4549			CR7HIX	7544	0.6
80	CP80	85→94	BPR6HS	7022			BPR6HIX	4085	0.7
	CS80CD	83→87	BPR6HS	7022			BPR6HIX	4085	0.7
	FR80D	84→87	BPR6HS	7022			BPR6HIX	4085	0.7
	RM80T	78→85	B10EG	3630			BR10EIX	6801	0.6
	RM80X G, H, J, K, L	86→90	B9EG	3530			BR9EIX	3981	0.7
	RM80X M, N, P, R, S, T, V	91→99	B10EG	3630			BR10EIX	6801	0.7
	RM80 K1	00→01	BR10ES	4832			BR10EIX	6801	0.8
85	RM85 /L K3-K9, L0-L6	02→	BR10ES	4832			BR10EIX	6801	0.8
100	AH100	94→97	BPR7HS	6422			BPR7HIX	5944	0.6
	GP100 All models	78→92	B8HS	5510			BR8HIX	7001	0.7
	RM100	76→81	B9EG	3530			BR9EIX	3981	0.7
	RM100 K4	03→04	R6252K-105	2741					0.7
	TS100ER, TS100ERZ	78→89	B8ES	2411			BR8EIX	5044	0.7
110	UG 110 Hokuto	99→02	BPR7HS	6422			BPR7HIX	5944	0.6
	UK110 Address	15→	CPR7EA-9	3901			CR7EIX	7385	0.9
125	AN125 S	95→96	CR8E	1275			CR8EIX	4218	0.6
	AN125 T,V,W	96→11/98	CR7E	4578			CR7EIX	7385	0.6
	AN125 X	11/98→	CR8E	1275			CR8EIX	4218	0.7
	CS125D	83→87	D8EA	2120	DR8EVX	6354	DR8EIX	6681	0.7
	DR125 SEX-SEY	99→01	DR8EA	7162	DR8EVX	6354	DR8EIX	6681	0.7
	DR125S D/F/H/J	82→94	DR8ES-L	2923	DR8EVX	6354	DR8EIX	6681	0.7
	DR125SM	08→12	CR8E	1275			CR8EIX	4218	0.7
	DR-Z125L	10→	DR8EA	7162	DR8EVX	6354	DR8EIX	6681	0.7
	FL125 S Address	07→14	CR8E	1275			CR8EIX	4218	0.7
	GN125 W-X	93→01	DR8EA	7162	DR8EVX	6354	DR8EIX	6681	0.7
	GP125 All models	78→89	B8HS	5510			BR8HIX	7001	0.7
	GS125ES, D All models	82→00	DR8ES-L	2923	DR8EVX	6354	DR8EIX	6681	0.7
	GSX-R125	17→	MR8E-9	90527					0.9
	GSX-S125	17→	MR8E-9	90527					0.9
	GT125	74→80	B8HS	5510			BR8HIX	7001	0.6
	GZ125 W, X, Y, K1-K3 Marauder	98→03	DR8EA	7162	DR8EVX	6354	DR8EIX	6681	0.6
	GZ125 K4-L1	04→11	CR8E	1275			CR8EIX	4218	0.7
	RG125 UC, G, H, J, J2	85→94	BR8ES	5422			BR8EIX	5044	0.6
	RG125FU-N, P, R	91→95	BR9ECM	3252			BR9ECMIX	2707	0.7
	RG125U Wolf	91→95	BR9ECM	3252			BR9ECMIX	2707	0.6
	RM125 E, F, G, H, J	84→88	BR9EG	3230			BR9EIX	3981	0.5
	RM125 K, L, M	89→91	B9EG	3530			BR9EIX	3981	0.5
	RM125 N, R, S	92→95			R4118S-9	3245			0.6
	RM125 T, V, W, K1-K8	96→08			R6918B-8	4492			0.6
	RV125 Van Van K4-K5	03→05	CR8E	1275			CR8EIX	4218	0.7
	TS125 (A/B)	76→77	B8HS	5510			BR8HIX	7001	0.7
	TS125 (C,ER/X/Z/D/XUE/XE)	78→88	B8ES	2411			BR8EIX	5044	0.7
	TS125R K, L, M, N, P, R	89→96	BR9ES	5722			BR9EIX	3981	0.7
	UC125 X Epicuro	99→02	CR8E	1275			CR8EIX	4218	0.7
	UH125 K2-K9, L0-L5 Burgman	02→	CR8E	1275			CR8EIX	4218	0.7
	UX125 Sixteen 125	07→11	CR8E	1275			CR8EIX	4218	0.7
	VL125 Y, K1-K5 Intruder	99→08	CR8E	1275			CR8EIX	4218	0.7
	200	AN200 K7 Burgman	07→	CR8EK	3478			CR8EIX	4218
DR200S		86→	DR8ES-L	2923	DR8EVX	6354	DR8EIX	6681	0.6
GT200X5		79→82	B8ES	2411			BR8EIX	5044	0.7
SB200		79→83	B8ES	2411			BR8EIX	5044	0.7



CC	MODEL	DATE	STANDARD COPPER CORE	STOCK NUMBER	PLATINUM OR GOLD PALLADIUM	STOCK NUMBER	IRIDIUM	STOCK NUMBER	GAP MM
SUZUKI (CONTINUED)									
250	AN250 W, X, Y, K1-K3 Burgman	→03	CR8EK	3478			CR8EIX	4218	0.7
	AN250 K4-K6 Burgman	04→06	CR7EK	7546			CR7EIX	7385	0.7
	DL250 V-Strom	17→	CPR7EA-9	3901			CR7EIX	7385	0.9
	GN250 F, J, K, L, M, N, P, R, T	87→97	DR8EA	7162	DR8EVX	6354	DR8EIX	6681	0.6
	GS250T, T/X	80→84	DR8ES	5423			DR9EIX	4772	0.7
	GSX250E T, X, Z	80→85	DR8ES	5423			DR9EIX	4772	0.7
	GSX250R	17→	CPR7EA-9	3901			CR7EIX	7385	0.9
	GT250K, L, M	73→75	B8ES	2411			BR8EIX	5044	0.7
	GT250A/B/C (½", 12.7mm Thread Reach)	76→78	B8HS	5510			BR8HIX	7001	0.7
	GT250A/B/C (¾", 19mm Thread Reach)	76→78	B9ES	2611			BR9EIX	3981	0.7
	GT250X7 EN/EX	78→83	B9ES	2611			BR9EIX	3981	0.7
	GW250 L2-L5 Inazuma, Z	12→	CR7E	4578			CR7EIX	7385	0.7
	PE250 B/C	77→78	B8EG	3430			BR8EIX	5044	0.5
	PE250 N/T/X/Z	79→82	BR10EG	3830			BR10EIX	6801	0.6
	RG250 Gamma	83→89	BR9ES	5722			BR9EIX	3981	0.7
	RGV250K, L	89→90	BR9ES	5722			BR9EIX	3981	0.7
	RGV250M, N, P, R	90→97	BR9ECM	3252			BR9ECMIX	2707	0.6
	RM250 Z/D	82→83	B8EG	3430			BR8EIX	5044	0.5
	RM250 E, F, G, H, J, K, L, M	84→91	B8EG	3430			BR8EIX	5044	0.5
	RM250 N, P, R, S	92→95			R4118S-8	3236			0.6
	RM250 T, V, W	96→99			R6918B-7	6259			0.6
	RM250 K1-K5	01→05	BR8EG	3130			BR8EIX	5044	0.6
	RMX250 K, L, M, N	89→92					BR8EIX	5044	0.5
	RMX250 P, R, S	93→95					BR9EIX	3981	0.5
	RMX250 T, V, W, X	96→99					BR9EIX	3981	0.5
	RM-Z250 K4-K5 (4-Stroke)	04→06	CR8EB	7784			CR8EIX	4218	0.7
	RM-Z250 K7-K9, L0-L3 (4-Stroke)	07→13					CR8EIA-10	4708	1.0
	RM-Z250 L4→	14→					CR8EIB-10	4948	1.0
	TS250 X	85→89	BR8ES	5422			BR8EIX	5044	0.6
	TS250ER N/T/X	79→83	BP7ES	2412			BPR7EIX	4055	0.7
	TU250 X, V, W	97→00	DR8EA	7162	DR8EVX	6354	DR8EIX	6681	0.6
	350	DR350S L, M, N, P, R	91→94	DPR9EA-9	5329			DPR9EIX-9	5545
DR350SE R, S, V, W, X		94→99	CR9EK	4548			CR9EIX	3521	0.7
380	GT380	72→78	B8ES	2411			BR8EIX	5044	0.7
400	AN400 X, Y, K1-K6 Burgman	99→07	CR7E	4578			CR7EIX	7385	0.7
	AN400 K7-K9, L0-L6 Burgman, Z	10/07→16	CR7E	4578			CR7EIX	7385	0.7
	AN400 L7 Burgman	17→					CR7EIA-9	91175	0.9
	DR400	80→82	DR8ES-L	2923	DR8EVX	6354	DR8EIX	6681	0.7
	DR-Z400E Y, K1-K5, DR-Z400S Y, K1-K5	99→07	CR8E	1275			CR8EIX	4218	0.7
	DR-Z400SM K5-K7	05→07	CR8E	1275			CR8EIX	4218	0.7
	GN400T	80→82	DR8ES-L	2923	DR8EVX	6354	DR8EIX	6681	0.7
	GS400 B/C	76→78	B8ES	2411			BR8EIX	5044	0.7
	GSF400M/N	91→92	CR8EK	3478			CR8EIX	4218	0.7
	GSF400P-R	93→95	CR9EK	4548			CR9EIX	3521	0.7
	GSX400E T/X, GSX400F, X/Z/D	80→84	DR8ES-L	2923	DR8EVX	6354	DR8EIX	6681	0.7
	GSX-R400H	86→89	C8HSA	6821			CR8HIX	7669	0.6
	PE400 T, X, Z	80→82	BR9EG	3230			BR9EIX	3981	0.7
	SP400	80→82	DR8ES-L	2923	DR8EVX	6354	DR8EIX	6681	0.7
450	GS450	85→88	B8ES	2411			BR8EIX	5044	0.7
	RMX450Z L0, L1	10→11					CR8EIB-10	4948	1.0
	RMX450Z L4→	14→					CR8EIB-10	4948	1.0
	RM-Z450 K4-K6 (4-Stroke)	04→06					CR8EIB-10	4948	1.0
	RM-Z450/Z K7-K9, L0-L6 (4-Stroke)	07→					DIMR8C10	92743	1.0
500	GS500E K, L, M, N, P, R, S, T, V, W, X, Y, K1-K3	89→05	DPR8EA-9	4929			DPR8EIX-9	2202	0.9
	GS500E / F K4-K9	04→09	DPR8EA-9	4929			DPR8EIX-9	2202	0.9
	GT500	75→77	B7HS	5110			BR7HIX	7067	0.6
	RG500 Gamma	85→89	BR9ES	5722			BR9EIX	3981	0.6
	RM500D	83→85	B8EG	3430			BR8EIX	5044	0.6
	T500	68→75	B8HS	5510			BR8HIX	7001	0.6
550	GS550 All models	77→85	B8ES	2411			BR8EIX	5044	0.7
	GSX550 EE/ESD/ESE/EFE	83→88	DR8ES	5423			DR9EIX	4772	0.7
600	GSF600 S, T, V, W, Y, K1-K4 Bandit Naked (Unfaired)	95→05	CR9EK	4548			CR9EIX	3521	0.7
	GSF600S T, V, W, Y, K1-K4 Bandit (Faired)	95→05	CR9EK	4548			CR9EIX	3521	0.7



CC	MODEL	DATE	STANDARD COPPER CORE	STOCK NUMBER	PLATINUM OR GOLD PALLADIUM	STOCK NUMBER	IRIDIUM	STOCK NUMBER	GAP MM
SUZUKI (CONTINUED)									
600	GSR600/S K6-K9, LO	06→10	CR9E	6263			CR9EIX	3521	0.7
	GSX600F J, K, L, M, N, P, R, S, V	88→97	DR8ES	5423			DR9EIX	4772	0.7
	GSX600F T, V, W, X, Y, K1-K4	97→04	CR9EK	4548			CR9EIX	3521	0.7
	GSX-R600 V, W, X, K1-K7	97→07	CR9E	6263			CR9EIX	3521	0.7
	GSX-R600 K8-K9, LO-L6 (Incl. Tyco)	08→					CR9EIA-9	6289	0.9
	RF600R P/R/S/V	93→97	CR9E	6263			CR9EIX	3521	0.7
VS600 GLS	95→97	DPR8EA-9	4929			DPR8EIX-9	2202	0.9	
650	AN650 K3-K5 Burgman	03→05	CR8E	1275			CR8EIX	4218	0.7
	AN650A K4-K9, L1-L6 Burgman	04→	CR8E	1275			CR8EIX	4218	0.7
	DL650 K4-K6 V-Strom	03→06	CR8E	1275			CR8EIX	4218	0.7
	DL650 K7-K9, LO V-Strom (Twin Spark)	07→10	CR8E	1275			CR8EIX	4218	0.7
	DL650A V-Strom XP (Twin Spark)	2010	CR8E	1275			CR8EIX	4218	0.7
	DL650AL1 V-Strom 650 ABS (Twin Spark)	2011	CR8E	1275			CR8EIX	4218	0.7
	DL650AL2-AL6 V-Strom 650 ABS (Twin Spark)	12→16					CR8EIA-9	4286	0.9
	DL650AL7 V-Strom 650 Incl. XT & GTA (Twin Spark)	17→	MR8E-9	90527					0.9
	DR650RSE Models and RE models	91→95	DPR9EA-9	5329			DPR9EIX-9	5545	0.9
	DR650SET	95→97	CR10E	6264			CR10EIX	6482	0.7
	GS650 All models (Incl. Katana)	81→84	DR8ES-L	2923	DR8EVX	6354	DR8EIX	6681	0.7
	GSF650 K5, K6 Bandit	05→06	CR8EK	3478			CR8EIX	4218	0.7
	GSF650 K7 Bandit (Liquid Cooled)	2007	CR9E	6263			CR9EIX	3521	0.6
	GSF650 K8-K9, LO Bandit (Liquid Cooled)	08→10	CR8E	1275			CR8EIX	4218	0.7
	GSX650F	2007	CR9E	6263			CR9EIX	3521	0.6
	GSX650F	08→16	CR8E	1275			CR8EIX	4218	0.7
	LS650 All models	87→98	DPR8EA-9	4929			DPR8EIX-9	2202	0.9
	SFV650 Gladius (Twin Spark)	09→15					CR8EIA-9	4286	0.9
	SV650, SV650S X/Y/K1-K6	99→06	CR8E	1275			CR8EIX	4218	0.7
	SV650, SV650S K7-K9, LO-L5	07→15	CR8E	1275			CR8EIX	4218	0.7
	SV650 (Twin Spark)	16→	MR8E-9	90527					0.9
XF650 V-W-X-Y Freewind	97→02	CR10E	6264			CR10EIX	6482	0.7	
670	XN85 650 Turbo	83→86	DR8ES	5423			DR9EIX	4772	0.7
750	DR750 SJ/SK	88→90	DPR9EA-9	5329			DPR9EIX-9	5545	0.9
	GS750 DB, EC, EN, GL	76→81	B8ES	2411			BR8EIX	5044	0.7
	GSR750 (Incl. GSR750Z)	11→					CR9EIA-9	6289	0.9
	GSX750 W, X, Y, K1	97→01	CR9EK	4548			CR9EIX	3521	0.7
	GSX750E T/EX/ESD/ESE/ESF/ESG	83→89	DR8ES-L	2923	DR8EVX	6354	DR8EIX	6681	0.7
	GSX750F K/L/M/N/P/R/S/T	89→96	JR9C	6193					0.7
	GSX750F W, X, Y, K1-K5	97→05	CR9EK	4548			CR9EIX	3521	0.7
	GSX750SZ,SD Katana	82→83	D7EA	7912					0.7
	GSX750SE,SF Katana	84→85	DR8ES-L	2923	DR8EVX	6354	DR8EIX	6681	0.7
	GSX-R750 F, G, H	85→88	DR8ES	5423			DR9EIX	4772	0.7
	GSX-R750 J, K	88→89	JR9C	6193					0.7
	GSX-R750 L, M	89→92	CR10EK	2360			CR10EIX	6482	0.7
	GSX-R750 WN, WP, WR, WS	91→96	CR9E	6263			CR9EIX	3521	0.7
	GSX-R750 T, V, W, X, Y, K1-K7	96→07	CR9E	6263			CR9EIX	3521	0.7
	GSX-R750 K8-K9, LO-L6	08→					CR9EIA-9	6289	0.9
	GSX-S750	17→					CR9EIA-9	6289	0.9
	VS750GLP F, G, H, J, K, L, M	85→91	DPR8EA-9	4929			DPR8EIX-9	2202	0.9
800	DR800 SL, SM	90→92	DPR9EA-9	5329			DPR9EIX-9	5545	0.9
	VL800 K1-K5	01→05	DPR7EA-9	5129			DPR7EIX-9	7803	0.9
	VL800 K6 C800 Intruder	06→09	DPR7EA-9	5129			DPR7EIX-9	7803	0.9
	VL800 LO Intruder C800	10→	DR7EA	7839					0.7
	VS800GL M, P, R, S, T, V	91→97	DPR8EA-9	4929			DPR8EIX-9	2202	0.9
	VX800 L/M/R	90→96	DPR8EA-9	4929			DPR8EIX-9	2202	0.9
	VZ800 V, W, X, Y, K1 Marauder	97→01	DPR8EA-9	4929			DPR8EIX-9	2202	0.9
	VZ800 K5→ Intruder M800	05→09	DPR7EA-9	5129			DPR7EIX-9	7803	0.9
	VZ800 LO Intruder M800	10→	DR7EA	7839					0.7
850	GS850 GN/GT/GX/GZ/GD/GE/GG	79→88	B8ES	2411			BR8EIX	5044	0.7
900	RF900R R, S, T, V, W	94→99	CR9E	6263			CR9EIX	3521	0.7
1000	DL1000 K2-K9 V-Strom	02→09	CR8EK	3478			CR8EIX	4218	0.7
	GS1000 EC/EN/ET/GT/GX/SN	80→82	B8ES	2411			BR8EIX	5044	0.7
	GSX1000 SZ/SD Katana	81→85	DR8ES-L	2923	DR8EVX	6354	DR8EIX	6681	0.7
	GSX-R1000 K1-K6	00→06	CR9E	6263			CR9EIX	3521	0.7
	GSX-R1000 K6 Phantom	2006	CR9E	6263			CR9EIX	3521	0.7



CC	MODEL	DATE	STANDARD COPPER CORE	STOCK NUMBER	PLATINUM OR GOLD PALLADIUM	STOCK NUMBER	IRIDIUM	STOCK NUMBER	GAP MM
SUZUKI (CONTINUED)									
1000	GSX-R1000 K7-K9, L0-L6	07→16					CR9EIA-9	6289	0.9
	GSX-R1000, GSX-R1000R L7→	17→					CR9EIA-9	6289	0.9
	GSX-R1000ZSE	2014					CR9EIA-9	6289	0.9
	GSX-S1000	15→					CR9EIA-9	6289	0.9
	SV1000/S K3-K5	03→05	CR8EK	3478			CR8EIX	4218	0.7
	SV1000 Classic	07→08	CR8EK	3478			CR8EIX	4218	0.7
	TL1000R W, Y, K1-K3	98→03	CR9EK	4548			CR9EIX	3521	0.7
	TL1000S V, W, X, Y	97→01	CR8EK	3478			CR8EIX	4218	0.7
1037	DL1000 L4 V-Strom (Twin Spark)	14→19					LMAR8BI-9	91909	0.9
	V-STROM 1050, 1050 XT (Twin Spark)	20→					LMAR8BI-9	91909	0.9
1100	GS1100GZ	82→86	B8ES	2411			BR8EIX	5044	0.7
	GSX1100 ET/X/Z/S/ESD,SZ ,SD (Katana)	79→85	DR8ES-L	2923	DR8EVX	6354	DR8EIX	6681	0.7
	GSX1100 EFE/EF/EFF/EG/EFG	84→88	DR8ES	5423			DR9EIX	4772	0.7
	GSX1100 FJ, FK, FL, FM, FN, FP, FR, FS	87→96	JR9B	3188			DR9EIX	4772	0.6
	GSX1100 GM, GN, GP, GR	91→94	JR9B	3188			DR9EIX	4772	0.6
	GSX-R1100 G, H, J	86→89	JR9B	3188			DR9EIX	4772	0.6
	GSX-R1100 K, L, M, N	89→93	JR9B	3188			DR9EIX	4772	0.6
	GSX-R1100 W-P, R, S, T	93→96	CR9E	6263			CR9EIX	3521	0.7
1200	GSF1200S T, V, W, X, Y, K1-K6 Bandit (Faired)	96→06	JR9B	3188			DR9EIX	4772	0.6
	GSF1200 T, V, W, X, Y, K1-K6 Bandit Naked (Unfaired)	96→06	JR9B	3188			DR9EIX	4772	0.6
1250	GSF1250/SA Bandit K7-K9, L0→	07→	CR7E	4578			CR7EIX	7385	0.8
1255	GSX1250FA Bandit (Incl. GSX1250FA Z)	10→	CR7E	4578			CR7EIX	7385	0.7
1300	GSX1300 B-King	07→12					CR9EIA-9	6289	0.9
	GSX1300R X, Y, K1-K5 Hayabusa	99→07	CR9E	6263			CR9EIX	3521	0.7
1340	GSX1300R Hayabusa	08→					CR9EIA-9	6289	0.9
1400	GSX1400 K2-K6	01→06	CR8EK	3478			CR8EIX	4218	0.7
	GSX1400 FE - K7	06→09	CR8EK	3478			CR8EIX	4218	0.7
	VS1400GLP-H, J, R, S, T, V, W (Intruder)	87→99	DPR8EA-9	4929			DPR8EIX-9	2202	0.9
1500	C1500T Intruder	13→	CPR6EA-9	6899					0.9
	VL1500 LC/X	98→03	DPR7EA-9	5129			DPR7EIX-9	7803	0.9
	VL1500 →K5	→05	DPR7EA-9	5129			DPR7EIX-9	7803	0.9
	VZ1500 L0 Intruder M1500	10→	CR6E	6965					0.7
1600	VZ1600 K4-K5	03→04	DPR6EA-9	5531					0.9
1800	VLR1800 C1800R/RT Intruder	08→12	CR8EK	3478			CR8EIX	4218	0.7
	VZR1800 M1800R Intruder K6-K9, L0→	06→	CR8EK	3478			CR8EIX	4218	0.7

SWM									
125	125TLM	77→84	BP5ES	6511			BPR5EIX	6597	0.4
200	TL200	→84	BP5ES	6511			BPR5EIX	6597	0.4
240	TL240	82→84	BP5ES	6511			BPR5EIX	6597	0.4
320	320TLM	77→84	BP5ES	6511			BPR5EIX	6597	0.4
350	TL350	83→84	BP5ES	6511			BPR5EIX	6597	0.4

SYM									
50	City Hopper	98→03	BR8HSA	5539			BPR8HIX	6742	0.6
	DD50 City Trek / Sport	02→	BR8HSA	5539			BPR8HIX	6742	0.6
	Fiddle	98→	BR8HSA	5539			BPR8HIX	6742	0.6
	Fiddle II 50	08→13	BR8HSA	5539			BPR8HIX	6742	0.7
	Jet 50	98→	BR8HSA	5539			BPR8HIX	6742	0.6
	Jet 50 Sport X S/SE/SR/XS	06→	BR8HSA	5539			BPR8HIX	6742	0.7
	Jungle	98→02	BR8HSA	5539			BPR8HIX	6742	0.6
	Mask	98→	BR8HSA	5539			BPR8HIX	6742	0.6
	Mio 50	06→	CR6HSA	2983			CR6HIX	7274	0.7
	Red Devil	98→	BR8HSA	5539			BPR8HIX	6742	0.6
	Simply 50	08→10	CR7HSA	4549			CR7HIX	7544	0.7
	Super Fancy	98→03	BR8HSA	5539			BPR8HIX	6742	0.6
	100	Jet 100	99→	BR8HSA	5539			BPR8HIX	6742
Jet 100 Sport X S/SR Jet			BR8HSA	5539			BPR8HIX	6742	0.6
Mio 100			CR6HSA	2983			CR6HIX	7274	0.7
125	Attila, Super Duke	98→00	CR7HSA	4549			CR7HIX	7544	0.6
	Euro MX 125	05→	CR8E	1275			CR8EIX	4218	0.7



CC	MODEL	DATE	STANDARD COPPER CORE	STOCK NUMBER	PLATINUM OR GOLD PALLADIUM	STOCK NUMBER	IRIDIUM	STOCK NUMBER	GAP MM
SYM (CONTINUED)									
125	Fiddle II 125	08→13	CR7HSA	4549			CR7HIX	7544	0.6
	GTS Voyager 125	05→07	CR8E	1275			CR8EIX	4218	0.8
	HD Orbit 125	04→	CR8E	1275			CR8EIX	4218	0.7
	Husky	98→	DR8EA	7162	DR8EVX	6354	DR8EIX	6681	0.6
	Joyride 125 (12.7mm Thread Reach)	02→04	CR7HSA	4549			CR7HIX	7544	0.6
	Joyride 125 (19mm Thread Reach)	05→	CR8E	1275			CR8EIX	4218	0.7
	Megalo 125	01→	CR7HSA	4549			CR7HIX	7544	0.6
	Shark 125 / R	99→05	CR8E	1275			CR8EIX	4218	0.8
	Simply 125	08→	CR7HSA	4549			CR7HIX	7544	0.7
	Symphony SR125	09→	CR7HSA	4549			CR7HIX	7544	0.7
	Voyager 125		CR8E	1275			CR8EIX	4218	0.7
	VS 125	06→	CR8E	1275			CR8EIX	4218	0.7
	Wolf 125		DR7EA	7839					0.7
	XS 125		DR7EA	7839					0.7
150	Symphony SR150	09→	CR7HSA	4549			CR7HIX	7544	0.7
180	HD Orbit 180	04→	CR8E	1275			CR8EIX	4218	0.7
	Joyride 180	02→	CR8E	1275			CR8EIX	4218	0.7
200	HD Orbit 200		CR8E	1275			CR8EIX	4218	0.7
	Joyride 200	09→	CR8E	1275			CR8EIX	4218	0.7
250	GTS Voyager 250	05→	CR8E	1275			CR8EIX	4218	0.7
300	Citycom 300	08→	CR8E	1275			CR8EIX	4218	0.7
	GTS 300		CR8E	1275			CR8EIX	4218	0.7
500	500 GT/XP	04→	CR7EKB	4455			CR7EIX	7385	0.8

TAMORETTI									
50	Retro 50 ZN50QT-E	05→	CR7HSA	4549			CR7HIX	7544	0.7
125	Retro 125 TN125-E	09→	CR7HSA	4549			CR7HIX	7544	0.7
	Stealth 125	08→	CR7HSA	4549			CR7HIX	7544	0.7

TGB									
50	202 Classic	02→	BPR7HS	6422			BPR7HIX	5944	0.5
	302 Sport	02→	BPR7HS	6422			BPR7HIX	5944	0.5
	303R Hawk	04→10	BPR7HS	6422			BPR7HIX	5944	0.5
	AKROStec	03→05	BPR7HS	6422			BPR7HIX	5944	0.5
	Delivery 50	03→	BPR7HS	6422			BPR7HIX	5944	0.5
	R50X	05→	BPR7HS	6422			BPR7HIX	5944	0.5
125	204 Classic	02→07	CR7HSA	4549			CR7HIX	7544	0.7
	303R Hawk	07→10	CR7HSA	4549			CR7HIX	7544	0.7
	304 Sport	02→	CR7HSA	4549			CR7HIX	7544	0.7
	404 Executive	02→07	CR7HSA	4549			CR7HIX	7544	0.7
	Bellavita 125i	13→	CR7E	4578			CR7EIX	7385	0.7
	Delivery 125	05→	CR7HSA	4549			CR7HIX	7544	0.7
	R125X	08→	CR7HSA	4549			CR7HIX	7544	0.7
	X-Motion 125	09→	CR8E	1275			CR8EIX	4218	0.7
300	Bellavita 300i	13→	CR8E	1275			CR8EIX	4218	0.7

THE BLACK DOUGLAS MOTORCYCLE CO.									
125	Claret Classic	13→	DR8EA	7162	DR8EVX	6354	DR8EIX	6681	0.8
	Countryman Deluxe	13→	DR8EA	7162	DR8EVX	6354	DR8EIX	6681	0.8
	Jade Wonder	13→	DR8EA	7162	DR8EVX	6354	DR8EIX	6681	0.8
	Original Drayton	13→	DR8EA	7162	DR8EVX	6354	DR8EIX	6681	0.8
	Silent Grey	13→	DR8EA	7162	DR8EVX	6354	DR8EIX	6681	0.8
	Sport Imperial	13→	DR8EA	7162	DR8EVX	6354	DR8EIX	6681	0.8
230	Claret Classic	13→	DR8EA	7162	DR8EVX	6354	DR8EIX	6681	0.8
	Countryman Deluxe	13→	DR8EA	7162	DR8EVX	6354	DR8EIX	6681	0.8
	Jade Wonder	13→	DR8EA	7162	DR8EVX	6354	DR8EIX	6681	0.8
	Original Drayton	13→	DR8EA	7162	DR8EVX	6354	DR8EIX	6681	0.8
	Silent Grey	13→	DR8EA	7162	DR8EVX	6354	DR8EIX	6681	0.8
	Sport Imperial	13→	DR8EA	7162	DR8EVX	6354	DR8EIX	6681	0.8



CC	MODEL	DATE	STANDARD COPPER CORE	STOCK NUMBER	PLATINUM OR GOLD PALLADIUM	STOCK NUMBER	IRIDIUM	STOCK NUMBER	GAP MM
TM RACING									
85	MX 85	12→	BR9EG	3230			BR9EIX	3981	0.6
100	MX 100	12→	BR9EG	3230			BR9EIX	3981	0.6
125	MX 125	12→	BR9EG	3230			BR9EIX	3981	0.6
	SMM/SMR 125	12→	BR9EG	3230			BR9EIX	3981	0.6
144	MX 144	12→	BR9EG	3230			BR9EIX	3981	0.6
250	EN 250 (2-stroke)	12→	BR8EG	3130					0.6
	MX 250 (2-stroke)	12→	BR8EG	3130					0.6
	SMM, SMR 250 (2-stroke)	12→	BR8EG	3130					0.6
300	EN 300 (2-stroke)	12→	BR8EG	3130					0.6
	MX 300 (2-stroke)	14→	BR8EG	3130					0.6
	SMM, SMR 300 (2-stroke)	12→	BR8EG	3130					0.6
450	EN 450Fi	14→					CR9EIX	3521	0.8
	MX 450Fi	14→					CR9EIX	3521	0.8
	SMM, SMR, SMX 450Fi	14→					CR9EIX	3521	0.8
530	EN 530F	14→	CR8E	1275			CR8EIX	4218	0.8
	MX 530F	14→	CR8E	1275			CR8EIX	4218	0.8
	SMM, SMR, SMX 530F	14→	CR8E	1275			CR8EIX	4218	0.8

TOMOS									
50	A3/A5K	84→96	B6HS	4510			BR6HIX	3419	0.5
	AT50, ATX50, NTX50	86→91	B6HS	4510			BR6HIX	3419	0.5

TRIUMPH PRE-1989									
250-500	Twins with 3/4", 19mm Thread Reach		B8ES	2411			BR8EIX	5044	0.6
650	T120, R, V Bonneville	→68	B7ES	1111			BR7EIX	6664	0.6
	T120, R, V Bonneville	68→74	B8ES	2411			BR8EIX	5044	0.6
	TR6 (12.7mm Thread Reach)	56→60	B7HS	5110			BR7HIX	7067	0.6
	TR6 Thunderbird/Daytona	67→73	B6ES	7310					0.6
	TR6C Trophy (19mm Thread Reach)	67→73	B8ES	2411			BR8EIX	5044	0.6
	TR65 Thunderbird	81→83	B6ES	7310					0.6
	TR65T Tiger Trail	1982	B6ES	7310					0.6
750	T140E, T140D Bonneville, TSX4	78→	B6ES	7310					0.6
	T140V Bonneville	73→88	B8ES	2411			BR8EIX	5044	0.6
	T150/160 Trident (Incl. BSA, A75 and Rocket 3)	→75	B8ES	2411			BR8EIX	5044	0.6
	TR7T Tiger Trail	81→82	B6ES	7310					0.6
	TSX8, TSS		C8E	7471			CR8EIX	4218	0.6

TRIUMPH 1991-ON									
600	Daytona 600	03→04	CR9EK	4548			CR9EIX	3521	0.7
	TT 600	99→03	CR9EK	4548			CR9EIX	3521	0.7
	Speed Four	02→	CR9EK	4548			CR9EIX	3521	0.7
650	Daytona 650	04→05	CR9EK	4548			CR9EIX	3521	0.7
660	Street Triple S (A2 Licence)	17→					CR9EIA-9	6289	0.9
675	Daytona 675 Triple	05→08	CR9EK	4548			CR9EIX	3521	0.7
	Daytona 675 Triple	12/08→12	CR9EK	4548			CR9EIX	3521	0.7
	Daytona 675 (Incl R)	13→					CR9EIA-9	6289	0.9
	Street Triple	07→16	CR9EK	4548			CR9EIX	3521	0.7
	Street Triple R, RX	08→16	CR9EK	4548			CR9EIX	3521	0.7
750	Speed Triple 750	1997	DPR8EA-9	4929			DPR8EIX-9	2202	0.9
	Trident, Daytona	91→98	DPR8EA-9	4929			DPR8EIX-9	2202	0.9
765	Daytona Moto2™ 765	2019					CR9EIA-9	6289	0.9
	Street Triple R, RS, S	17→					CR9EIA-9	6289	0.9
790	America	04→06	DPR8EA-9	4929			DPR8EIX-9	2202	0.9
	Bonneville (Incl. Black)	00→06	DPR8EA-9	4929			DPR8EIX-9	2202	0.9
	Bonneville America	01→06	DPR8EA-9	4929			DPR8EIX-9	2202	0.9
	Bonneville T100	02→04	DPR8EA-9	4929			DPR8EIX-9	2202	0.9
	Speedmaster	02→	DPR8EA-9	4929			DPR8EIX-9	2202	0.9
799	Tiger 800, Tiger 800 XC (Incl. ABS & SE)	11→	CR9EK	4548			CR9EIX	3521	0.7
865	America 900	06→	DPR8EA-9	4929			DPR8EIX-9	2202	0.9
	America LT	14→	DPR8EA-9	4929			DPR8EIX-9	2202	0.9



CC	MODEL	DATE	STANDARD COPPER CORE	STOCK NUMBER	PLATINUM OR GOLD PALLADIUM	STOCK NUMBER	IRIDIUM	STOCK NUMBER	GAP MM
TRIUMPH 1991-ON (CONTINUED)									
865	Bonneville 900 (Incl. Black)	06→15	DPR8EA-9	4929			DPR8EIX-9	2202	0.9
	Bonneville SE	12/08→15	DPR8EA-9	4929			DPR8EIX-9	2202	0.9
	Bonneville T100 (Incl. all special editions)	04→15	DPR8EA-9	4929			DPR8EIX-9	2202	0.9
	Bonneville T100 50th SE	07/2014	DPR8EA-9	4929			DPR8EIX-9	2202	0.9
	Scrambler	05→	DPR8EA-9	4929			DPR8EIX-9	2202	0.9
	Speedmaster	05→	DPR8EA-9	4929			DPR8EIX-9	2202	0.9
	Thrupton 900	03→	DPR8EA-9	4929			DPR8EIX-9	2202	0.9
	Thrupton SE (Incl. Ace)	10→	DPR8EA-9	4929			DPR8EIX-9	2202	0.9
885	Adventurer	96→01	DPR8EA-9	4929			DPR8EIX-9	2202	0.9
	Daytona, Daytona Super III	91→96	DPR8EA-9	4929			DPR8EIX-9	2202	0.9
	Legend TT	98→01	DPR8EA-9	4929			DPR8EIX-9	2202	0.9
	Speed Triple	94→96	DPR8EA-9	4929			DPR8EIX-9	2202	0.9
	Sprint	91→96	DPR8EA-9	4929			DPR8EIX-9	2202	0.9
	T509 Speed Triple	96→10/98	DPR8EA-9	4929			DPR8EIX-9	2202	0.9
	T709 Tiger	98→	DPR8EA-9	4929			DPR8EIX-9	2202	0.9
	Thunderbird	95→04	DPR8EA-9	4929			DPR8EIX-9	2202	0.9
	Thunderbird Sport	98→04	DPR8EA-9	4929			DPR8EIX-9	2202	0.9
	Tiger	91→98	DPR8EA-9	4929			DPR8EIX-9	2202	0.9
	Trident	91→98	DPR8EA-9	4929			DPR8EIX-9	2202	0.9
	Trophy	91→01	DPR8EA-9	4929			DPR8EIX-9	2202	0.9
900	Bonneville T100	16→	LMAR8A-9	4313					0.9
	Street Cup	15→	LMAR8A-9	4313					0.9
	Street Scrambler	19→	LMAR8A-9	4313					0.9
	Street Twin	15→	LMAR8A-9	4313					0.9
955	Daytona 955i (Ø12mm Plug)	98→01	DPR8EA-9	4929			DPR8EIX-9	2202	0.9
	Daytona 955i (Ø10mm Plug)	01→06	CR9EK	4548			CR9EIX	3521	0.7
	Speed Triple (Ø12mm Plug)	10/98→01	DPR8EA-9	4929			DPR8EIX-9	2202	0.9
	Speed Triple (Ø10mm Plug)	01→04	CR9EK	4548			CR9EIX	3521	0.7
	Sprint RS (Ø12mm Plug)	99→00	DPR8EA-9	4929			DPR8EIX-9	2202	0.9
	Sprint RS (Ø10mm Plug)	01→05	CR9EK	4548			CR9EIX	3521	0.7
	Sprint ST (Ø12mm Plug)	98→00	DPR8EA-9	4929			DPR8EIX-9	2202	0.9
	Sprint ST (Ø10mm Plug)	01→04	CR9EK	4548			CR9EIX	3521	0.7
	T595 Daytona	97→98	DPR8EA-9	4929			DPR8EIX-9	2202	0.9
	Tiger EFI	00→07	DPR8EA-9	4929			DPR8EIX-9	2202	0.9
1000	Daytona	91→93	DPR8EA-9	4929			DPR8EIX-9	2202	0.9
1050	Speed 94, 94R	04/15→	CR8EK	3478			CR8EIX	4218	0.7
	Speed Triple (Incl. R)	05→15	CR8EK	3478			CR8EIX	4218	0.7
	Speed Triple R, S	16→17					CR8EIA-9	4286	0.9
	Speed Triple RS, S	18→					CR9EIA-9	6289	0.9
	Sprint GT	10→	CR8EK	3478			CR8EIX	4218	0.7
	Sprint ST (Incl. ABS)	04→	CR8EK	3478			CR8EIX	4218	0.7
	Tiger (Incl. ABS)	06→	CR8EK	3478			CR8EIX	4218	0.7
	Tiger Sport	13→15	CR8EK	3478			CR8EIX	4218	0.7
	Tiger Sport	16→				CR8EIA-9	4286	0.9	
1180	Daytona 1200	91→00	DPR8EA-9	4929			DPR8EIX-9	2202	0.9
	Trophy 1200	91→03	DPR8EA-9	4929			DPR8EIX-9	2202	0.9
1200	Bonneville T120, T120 Black	15→	LMAR8A-9	4313					0.9
	Scrambler 1200 XC, XE	19→	LMAR8A-9	4313					0.9
	Speed Twin	19→	LMAR8A-9	4313					0.9
	Thrupton, Thrupton R	15→	LMAR8A-9	4313					0.9
1215	Tiger Explorer	12→	CR8EK	3478			CR8EIX	4218	0.7
	Trophy (Incl. SE)	11/12→	CR8EK	3478			CR8EIX	4218	0.7
1600	Thunderbird (Twin Spark)	09→	DPR6EA-9	5531					0.9
1700	Thunderbird (Twin Spark) 1700cc option engine	09→	DPR6EA-9	5531					0.9
	Thunderbird Commander (Twin Spark)	03/14→	DPR6EA-9	5531					0.9
	Thunderbird LT (Twin Spark)	03/14→	DPR6EA-9	5531					0.9
	Thunderbird Storm (Twin Spark)	11→	DPR6EA-9	5531					0.9
2300	Rocket III Incl. X (Twin Spark)	04→	DPR7EA-9	5129			DPR7EIX-9	7803	0.9
	Rocket III Classic (Twin Spark)	06→	DPR7EA-9	5129			DPR7EIX-9	7803	0.9
	Rocket III Touring (Twin Spark)	07→	DPR7EA-9	5129			DPR7EIX-9	7803	0.9



CC	MODEL	DATE	STANDARD COPPER CORE	STOCK NUMBER	PLATINUM OR GOLD PALLADIUM	STOCK NUMBER	IRIDIUM	STOCK NUMBER	GAP MM
URALMOTO									
650	Cobra, Red Star, Voyage	→00	BP7HS	5111			BPR7HIX	5944	0.8
750	Classic, Wolf	00→07	BP6HS	4511			BPR6HIX	4085	0.6

VERTEMATI									
500	S501		CR9EK	4548			CR9EIX	3521	0.7
	SR501		CR9EK	4548			CR9EIX	3521	0.7
570	S570	03→	CR9EK	4548			CR9EIX	3521	0.7

VESPA (SEE PIAGGIO)

VICTORY (POLARIS)									
1507	V92C and all 92 cu.inch models	99→01	DCPR6E	3481					1.0
	V92C and all 92 cu.inch models	02→04	CPR6EB-9	5958					0.8
1634	Hammer, Kingpin, Touring Cruiser	05→08	CPR6EB-9	5958					0.9
	Hammer 8-Ball, Kingpin 8-Ball, Vegas, Vegas 8-Ball, Vegas Jackpot	05→	CPR6EB-9	5958					0.9
1731	Arlen Ness Vision, Cory Ness Jackpot	10→	DCPR6E	3481					0.8
	Broadwalk	13→	DCPR6E	3481					0.8
	Cross Country, Cross Country Tour, Cross Roads, Jackpot, Vision 8-Ball	10→	DCPR6E	3481					0.8
	Hammer/S, Vegas Jackpot, Vision Street/Tour	08→	DCPR6E	3481					0.8
	High Ball	12→	DCPR6E	3481					0.8

VIXEN (SEE BASHAN)

VOR									
400	EN, MX, SM	00→	CR8EK	3478			CR8EIX	4218	0.7
503	EN, MX, SM	99→	CR8EK	3478			CR8EIX	4218	0.7
530	530 (2002)	02→	CR8EK	3478			CR8EIX	4218	0.7

WHITE KNUCKLE (SEE WK)

WK									
50	Bellissima	13→	CR7HSA	4549			CR7HIX	7544	0.7
	Go 50	13→	CR7HSA	4549			CR7HIX	7544	0.7
	GP50 (Air Cooled)	10→	BPR7HS	6422			BPR7HIX	5944	0.6
	Mii 50	14→	CR7HSA	4549			CR7HIX	7544	0.7
	WASP R50	14→	CR7HSA	4549			CR7HIX	7544	0.7
125	Bellissima	14→	CR7HSA	4549			CR7HIX	7544	0.7
	GP125	13→	CR7HSA	4549			CR7HIX	7544	0.7
	RT125	14→	CR6HSA	2983			CR6HIX	7274	0.7

WUYANG									
50	WY50QT Scooter	06→	C7HSA	4629			CR7HIX	7544	0.6
125	WY125-12	06→	DPR8EA-9	4929			DPR8EIX-9	2202	0.9
	WY125-16C	06→	DPR8EA-9	4929			DPR8EIX-9	2202	0.9
	WY125-24B Cub	06→	C7HSA	4629			CR7HIX	7544	0.6

XISPA									
125	X125R	07→08	BP5ES	6511			BPR5EIX	6597	0.6
250	X250R	07→08	BP5ES	6511			BPR5EIX	6597	0.6
273	X280R	07→08	BP5ES	6511			BPR5EIX	6597	0.6



CC	MODEL	DATE	STANDARD COPPER CORE	STOCK NUMBER	PLATINUM OR GOLD PALLADIUM	STOCK NUMBER	IRIDIUM	STOCK NUMBER	GAP MM
YAMAHA									
50	CA50 (Salient)	84→87	BP6HS	4511			BPR6HIX	4085	0.6
	CG50E Jog	88→92	BPR7HS	6422			BPR7HIX	5944	0.6
	CS50 Jog R (Air Cooled)	02→07	BR8HS	4322			BR8HIX	7001	0.6
	CS50 Jog-RR (Liquid Cooled 2-Stroke)	03→07	BR8HS	4322			BR8HIX	7001	0.7
	CS50Z Jog RR	07→12	BR8HS	4322			BR8HIX	7001	0.7
	CW50 RSP (Spy)	96→98	BR8HS	4322			BR8HIX	7001	0.6
	CW50/BW50 NG Bi-Wizz, Booster, Rocket	90→95	BPR7HS	6422			BPR7HIX	5944	0.6
	CW50/BW50 NG Bi-Wizz, Booster, Rocket	96→13	BR8HS	4322			BR8HIX	7001	0.6
	CW50T/BW	90→95	BPR7HS	6422			BPR7HIX	5944	0.6
	CW50T/BW	96→13	BR8HS	4322			BR8HIX	7001	0.6
	CY50 Jog-in	90→98	BPR7HS	6422			BPR7HIX	5944	0.5
	DT50	2004	BR7HS	4122			BR7HIX	7067	0.6
	DT50M/MX	86→95	BR7HS	4122			BR7HIX	7067	0.6
	DT50R	03→06	BR9ES	5722			BR9EIX	3981	0.7
	DT50SM	2004	BR9ES	5722			BR9EIX	3981	0.7
	EW 50 Slider / Stunt	00→02	BR9HS	4522			BR9HIX	5687	0.6
	FS1	87→91	BR7HS	4122			BR7HIX	7067	0.6
	FS1E	77→78	B7HS	5110			BR7HIX	7067	0.6
	LC50 Bop 2	80→81	BP4HS	3611					0.7
	MA50 M	86→93	BP4HS	3611					0.7
	MS50	85→87	BPR6HS	7022			BPR6HIX	4085	0.6
	NS50 Aerox R	13→	BR8HS	4322			BR8HIX	7001	0.6
	PW50 H/J/K/L	81→87	BP4HS	3611					0.6
	PW50S	88→	BPR4HS	7823					0.6
	QT50	86→93	BP4HS	3611					0.7
	RD50M/MX	86→89	B7HS	5110			BR7HIX	7067	0.6
	SA50 Pasola	82→86	BP4HS	3611					0.7
	T50	86→89	CR6HS	7023			CR6HIX	7274	0.6
	TT-R50E	06→	CR7HSA	4549			CR7HIX	7544	0.6
	TY50M	77→80	B7HS	5110			BR7HIX	7067	0.6
	TZR50 X-Power	03→04	BR9ES	5722			BR9EIX	3981	0.7
	U50/AD/C/E	65→71	B7HS	5110			BR7HIX	7067	0.6
	V50	83→86	BR6ES	4922					0.6
	V50FM	80→85	B7HS	5110			BR7HIX	7067	0.6
	V50MA	80→85	B6HS	4510			BR6HIX	3419	0.6
	XF50 Giggie	07→09	CR7E	4578			CR7EIX	7385	0.8
	YH50 WHY	99→03	BR8HS	4322			BR8HIX	7001	0.6
	YN50 Neo's, Ovetto	98→08	BR7HS	4122			BR7HIX	7067	0.6
	YN50 Neo's Easy (2-Stroke)	13→	BR8HS	4322			BR8HIX	7001	0.6
	YN50 Neo's 4s	09→	CR7E	4578			CR7EIX	7385	0.8
YQ50 Aerox, Nitro	98→07	BR8HS	4322			BR8HIX	7001	0.6	
YQ50 Aerox R	04→	BR8HS	4322			BR8HIX	7001	0.6	
YZ50H	80→81	B9ES	2611			BR9EIX	3981	0.6	
ZE50 (Zest)	93→96	BR7HS	4122			BR7HIX	7067	0.6	
65	YZ65	18→	BR9ECM	3252			BR9ECMIX	2707	0.7
70	V70	71→80	B7HS	5110			BR7HIX	7067	0.6
80	CV80	82→86	BPR6HS	7022			BPR6HIX	4085	0.6
	DT80MX	82→85	B8HS	5510			BR8HIX	7001	0.6
	DT80MXS	86→87	BP8HS	2630			BPR8HIX	6742	0.6
	LB2-80 Chappy	81→85	B6HS	4510			BR6HIX	3419	0.6
	PW80K	82→95	BP6HS	4511			BPR6HIX	4085	0.6
	PW80S	96→11	BPR6HS	7022			BPR6HIX	4085	0.6
	RD80LC11A	82→84	B8ES	2411			BR8EIX	5044	0.6
	T80 Townmate	83→97	CR7HS	7223			CR7HIX	7544	0.6
	TY80B	73→84	B6HS	4510			BR6HIX	3419	0.6
	V80	79→87	BPR6HS	7022			BPR6HIX	4085	0.6
	YZ80 (½", 12.7mm Thread Reach)	1974	B7HS	5110			BR7HIX	7067	0.5
	YZ80 B (½", 12.7mm Thread Reach)	1975	B8HS	5510			BR8HIX	7001	0.6
	YZ80 (¾", 19mm Thread Reach)	76→80	B8ES	2411			BR8EIX	5044	0.6
	YZ80 (¾", 19mm Thread Reach)	81→83	B9ES	2611			BR9EIX	3981	0.6
	YZ80 (¾", 19mm Thread Reach)	84→92	BR9EG	3230			BR9EIX	3981	0.5
	YZ80	93→99	B10EG	3630			BR10EIX	6801	0.5
	YZ80	00→01	BR10EG	3830			BR10EIX	6801	0.6



CC	MODEL	DATE	STANDARD COPPER CORE	STOCK NUMBER	PLATINUM OR GOLD PALLADIUM	STOCK NUMBER	IRIDIUM	STOCK NUMBER	GAP MM
YAMAHA (CONTINUED)									
85	YZ85	03→	BR10EG	3830			BR10EIX	6801	0.6
90	TT90-R	03→07	CR6HSA	2983			CR6HIX	7274	0.7
	V90	71→80	B7HS	5110			BR7HIX	7067	0.5
100	DT100 A/B (½", 12.7mm Thread Reach)	74→75	B8HS	5510			BR8HIX	7001	0.5
	DT100 C (¾", 19mm Thread Reach)	1976	B7ES	1111			BR7EIX	6664	0.5
	DT100	77→83	B8ES	2411			BR8EIX	5044	0.5
	RS100 (B/X/DX/S)	75→76	B8HS	5510			BR8HIX	7001	0.5
	RS100P	1978	BP6HS	4511			BPR6HIX	4085	0.5
	RT100	92→00	B7ES	1111			BR7EIX	6664	0.6
	RXS100	83→97	BR8HS	4322			BR8HIX	7001	0.6
	YB100	87→92	B7HS	5110			BR7HIX	7067	0.5
	YN100 Neos, Ovetto	11/99→03	BR8HS	4322			BR8HIX	7001	0.5
	YQ100 Aerox, Nitro	00→04	BR8HS	4322			BR8HIX	7001	0.5
	YZ100H	76→82					BR10EIX	6801	0.5
	YZ100K	1983	B9EG	3530			BR9EIX	3981	0.5
	YZ100L	1984	BR9EG	3230			BR9EIX	3981	0.6
114	XC115S D'elight	14→	CR6HSA	2983			CR6HIX	7274	0.6
125	AS3	71→76	B8HS	5510			BR8HIX	7001	0.6
	BL125 Beluga	85→87	BPR8HS	3725			BPR8HIX	6742	0.6
	Black X-max 125	09→	CPR9EA-9	2308			CR9EIX	3521	0.9
	BW's 125	10→11	CR7E	4578			CR7EIX	7385	0.8
	DT125 (E/ED/MX)	74→83	B8ES	2411			BR8EIX	5044	0.5
	DT125LC	84→87	BR8ES	5422			BR8EIX	5044	0.6
	DT125R	88→04	BR9ES	5722			BR9EIX	3981	0.6
	DT125RE	04→07	BR8ES	5422			BR8EIX	5044	0.7
	DT125X	04→07	BR8ES	5422			BR8EIX	5044	0.6
	GPD125A N-Max	15→	CPR8EA-9	2306			CR8EIX	4218	0.9
	HW125 Xenter	12→	CPR9EA-9	2308			CR9EIX	3521	0.9
	IT125 G, H, J	80→84	B9EG	3530			BR9EIX	3981	0.6
	MT-125	14→	CR9E	6263			CR9EIX	3521	0.8
	MW125 Tricity	14→	CR7E	4578			CR7EIX	7385	0.8
	NXC125 Cygnus X	04→	CR7E	4578			CR7EIX	7385	0.8
	RD125 (½", 12.7mm Thread Reach)	1975	B8HS	5510			BR8HIX	7001	0.6
	RD125 C-DX, DX, D-DX (¾", 19mm Thread Reach)	76→84	B8ES	2411			BR8EIX	5044	0.6
	RD125LC	85→86	BR9ES	5722			BR9EIX	3981	0.7
	RDZ125	87→89	BR9ES	5722			BR9EIX	3981	0.7
	RS125 (Z/DX)	76→84	B8HS	5510			BR8HIX	7001	0.5
	RS125E	74→80	B7HS	5110			BR7HIX	7067	0.6
	SR125	81→85	D8EA	2120	DR8EVX	6354	DR8EIX	6681	0.7
	SR125	89→03	DR8EA	7162	DR8EVX	6354	DR8EIX	6681	0.6
	TDR 125	93→97	BR9ES	5722			BR9EIX	3981	0.7
	TT-R125/LW	00→	CR7HSA	4549			CR7HIX	7544	0.7
	TT-R125E	05→	CR7HSA	4549			CR7HIX	7544	0.7
	TW125	98→04	DR8EA	7162	DR8EVX	6354	DR8EIX	6681	0.6
	TY125	75→89	B7ES	1111			BR7EIX	6664	0.6
	TZR125	87→93	BR9ES	5722			BR9EIX	3981	0.7
	TZR125R	93→97	BR9ECM	3252			BR9ECMIX	2707	0.7
	VP125 X-City	07→12	CPR9EA-9	2308			CR9EIX	3521	0.9
	WR125R	09→	CR8E	1275			CR8EIX	4218	0.7
	WR125X	09→	CR8E	1275			CR8EIX	4218	0.7
	XC125	92→96	CR6HSA	2983			CR6HIX	7274	0.6
	XC125 Cygnus	95→99	CR7E	4578			CR7EIX	7385	0.8
	XC125 Vity 125	08→	CR7E	4578			CR7EIX	7385	0.6
	XC125R Majesty S	14→	CPR8EA-9	2306			CR8EIX	4218	0.9
	XN125 Teos, Doodo	00→03	CR8E	1275			CR8EIX	4218	0.5
	XQ125 Maxster, Thunder	01→03	CR8E	1275			CR8EIX	4218	0.7
	XT125	82→85	D8EA	2120	DR8EVX	6354	DR8EIX	6681	0.7
	XT125R	05→	CR7HSA	4549			CR7HIX	7544	0.7
	XT125X	05→	CR7HSA	4549			CR7HIX	7544	0.7
	XV125 Virago	97→01	CR6HSA	2983			CR6HIX	7274	0.6
	XVS125 Drag Star	99→04	CR7HSA	4549			CR7HIX	7544	0.7
	YA6	64→67	B7HS	5110			BR7HIX	7067	0.6
	YBR125	05→	CR6HSA	2983			CR6HIX	7274	0.6



CC	MODEL	DATE	STANDARD COPPER CORE	STOCK NUMBER	PLATINUM OR GOLD PALLADIUM	STOCK NUMBER	IRIDIUM	STOCK NUMBER	GAP MM	
YAMAHA (CONTINUED)										
125	YBR125 Custom	09→	CR6HSA	2983			CR6HIX	7274	0.6	
	YP125 Majesty, Skyliner	99→13	CR8E	1275			CR8EIX	4218	0.7	
	YP125R X-Max 125	00→05	CR8E	1275			CR8EIX	4218	0.7	
	YP125R X-Max 125	06→13	CPR9EA-9	2308			CR9EIX	3521	0.9	
	YP125RA X-MAX 125	14→	CPR9EA-9	2308			CR9EIX	3521	0.9	
	YZ125 (Air Cooled)	74→80	B9EG	3530			BR9EIX	3981	0.5	
	YZ125 (Liquid Cooled)	81→91	B9EG	3530			BR9EIX	3981	0.5	
	YZ125	91→96	BR9EG	3230			BR9EIX	3981	0.5	
	YZ125	96→98	B9EG	3530			BR9EIX	3981	0.5	
	YZ125	98→05	BR9EG	3230			BR9EIX	3981	0.5	
	YZ125	05→					BR9EIX	3981	0.5	
	YZF-R125	08→	CR8E	1275			CR8EIX	4218	0.7	
175	DT175 (E/MX)	78→85	B8ES	2411			BR8EIX	5044	0.5	
	IT175H	81→83	B9EG	3530			BR9EIX	3981	0.5	
	TY175 (E/JC)	74→81	B7ES	1111			BR7EIX	6664	0.5	
200	CS5E	72→73	B8HS	5510			BR8HIX	7001	0.6	
	RD200 (All models except B)	76→83	B8ES	2411			BR8EIX	5044	0.6	
	RD200B (½", 12.7mm Thread Reach)	1976	B8HS	5510			BR8HIX	7001	0.6	
	RD200B (¾", 19mm Thread Reach)	1976	B8ES	2411			BR8EIX	5044	0.6	
	RS200	79→81	B8ES	2411			BR8EIX	5044	0.6	
WR200E	91→92	BR9ES	5722			BR9EIX	3981	0.6		
250	Black X-max 250	09→	DR8EA	7162	DR8EVX	6354	DR8EIX	6681	0.7	
	DT250 (E/MX)	75→79	B8EG	3430			BR8EIX	5044	0.6	
	IT250 D-K	77→83	B9EG	3530			BR9EIX	3981	0.6	
	MX250	1975	B8EG	3430			BR8EIX	5044	0.6	
	RD250 (D)	1977	B8ES	2411			BR8EIX	5044	0.6	
	RD250 (E/F)	78→79	B9ES	2611			BR9EIX	3981	0.7	
	RD250 (LC)	80→85	BR8ES	5422			BR8EIX	5044	0.6	
	SR250	80→82	BP7ES	2412			BPR7EIX	4055	0.7	
	SR250S	93→95	BP7ES	2412			BPR7EIX	4055	0.7	
	TDR250	88→92	BR9ES	5722			BR9EIX	3981	0.7	
	TT250R	03→05	CR9E	6263			CR9EIX	3521	0.8	
	TY250 A-D	73→77	B7ES	1111			BR7EIX	6664	0.5	
	TY250N	84→85	BR8ES	5422			BR8EIX	5044	0.6	
	TY250R	86→91	BR6ES	4922					0.6	
	TY250Z	93→96					BPR6EIX	6637	0.7	
	TZR250	87→91	BR9ES	5722			BR9EIX	3981	0.6	
	VP250 X-City	07→	DPR8EA-9	4929			DPR8EIX-9	2202	0.9	
	WR250F	01→03	CR8E	1275			CR8EIX	4218	0.7	
	WR250F (S)	04→06	CR8E	1275			CR8EIX	4218	0.7	
	WR250F (S)	07→	CR9E	6263			CR9EIX	3521	0.8	
	WR250R	08→	CR9EK	4548			CR9EIX	3521	0.7	
	WR250X	08→	CR9EK	4548			CR9EIX	3521	0.7	
	WR250Z	93→98	B8EG	3430			BR8EIX	5044	0.5	
	XS250 (E/CW/SE/C)	77→80	BP7ES	2412			BPR7EIX	4055	0.7	
	XT250	80→83	BP7ES	2412			BPR7EIX	4055	0.7	
	XV250 Virago	95→00	CR6HS	7023			CR6HIX	7274	0.6	
	XVS250 Drag Star	01→04	CR6HSA	2983			CR6HIX	7274	0.7	
	YBR250	09→11	DR8EA	7162	DR8EVX	6354	DR8EIX	6681	0.7	
	YP250 Majesty	96→04	DR8EA	7162	DR8EVX	6354	DR8EIX	6681	0.8	
	YP250R X-Max	05→11	DR8EA	7162	DR8EVX	6354	DR8EIX	6681	0.8	
	YP250RA X-MAX 250	12→	DPR8EA-9	4929			DPR8EIX-9	2202	0.9	
	YZ250	74→77	B8EG	3430			BR8EIX	5044	0.6	
	YZ250	78→81	B9EG	3530			BR9EIX	3981	0.6	
	YZ250 (2-Stroke)	82→	BR8EG	3130			BR8EIX	5044	0.6	
	YZ250F (4-Stroke)	01→13	CR8E	1275			CR8EIX	4218	0.7	
	YZ250F	14→	LMAR8G	95627					0.8	
	YZ250WR	93→04	B8EG	3430			BR8EIX	5044	0.6	
	264	VP300 Versity	03→04	DR8EA	7162	DR8EVX	6354	DR8EIX	6681	0.7
	321	MT-03	16→	CR8E	1275			CR8EIX	4218	0.7
		YZF-R3	15→	CR8E	1275			CR8EIX	4218	0.7
350	RD350 (Air Cooled) (½", 12.7mm Thread Reach)	73→74	B8HS	5510			BR8HIX	7001	0.6	
	RD350 (Air Cooled) (¾", 19mm Thread Reach)	1975	B8ES	2411			BR8EIX	5044	0.6	



CC	MODEL	DATE	STANDARD COPPER CORE	STOCK NUMBER	PLATINUM OR GOLD PALLADIUM	STOCK NUMBER	IRIDIUM	STOCK NUMBER	GAP MM
YAMAHA (CONTINUED)									
350	RD350LC-YPVS (Liquid Cooled)	83→85	BR8ES	5422			BR8EIX	5044	0.6
	RD350 (Liquid Cooled)	86→95	BR9ES	5722			BR9EIX	3981	0.6
	XT350	85→92	DR8ES-L	2923	DR8EVX	6354	DR8EIX	6681	0.6
400	DT400 (E/MX)	75→79	B9ES	2611			BR9EIX	3981	0.6
	FZR400 Genesis	86→87	CR8E	1275			CR8EIX	4218	0.7
	FZR400 EXUP	88→90	CR8E	1275			CR8EIX	4218	0.7
	FZR400 RR/SP	91→95	CR8E	1275			CR8EIX	4218	0.7
	IT400	76→79	B8EG	3430			BR8EIX	5044	0.6
	MX400	1975	B8EG	3430			BR8EIX	5044	0.6
	RD400 (C/D)	76→77	B8ES	2411			BR8EIX	5044	0.6
	RD400 (E/F)	78→79	B9ES	2611			BR9EIX	3981	0.6
	SR400	14→	BPR6ES	7822			BPR6EIX	6637	0.8
	WR400	98→00	CR8E	1275			CR8EIX	4218	0.7
	XS400 (E/2-E/F) (Ø14mm Plug)	77→82	BP7ES	2412			BPR7EIX	4055	0.6
	XS400 (Ø12mm Plug)	82→83	D8EA	2120	DR8EVX	6354	DR8EIX	6681	0.7
	YP400 Majesty	04→11	CR7E	4578			CR7EIX	7385	0.8
	YP400R X-MAX	13→	CR7E	4578			CR7EIX	7385	0.8
	YZ400 (C/E)	76→79	B8EG	3430			BR8EIX	5044	0.6
YZ400F	98→99	CR8E	1275			CR8EIX	4218	0.7	
426	WR426F Enduro	01→02	CR8E	1275			CR8EIX	4218	0.7
	YZ426F Motocross	00→03	CR8E	1275			CR8EIX	4218	0.7
450	WR450F (S)	04→11	CR8E	1275			CR8EIX	4218	0.7
	WR450F Injection	12→	CR8E	1275			CR8EIX	4218	0.8
	YZ450F	03→	CR8E	1275			CR8EIX	4218	0.7
465	IT465H	81→82	B8EG	3430			BR8EIX	5044	0.6
	YZ465H	80→82	B8EG	3430			BR8EIX	5044	0.6
490	YZ490 (J/K/L/N/S/T/U)	82→90	B8EG	3430			BR8EIX	5044	0.6
500	HL500	78→79	BP7ES	2412			BPR7EIX	4055	0.6
	RD500LC	84→87	BR9HS	4522			BR9HIX	5687	0.6
	SR500/E	78→83	BP7ES	2412			BPR7EIX	4055	0.6
	XP500 TMAX	01→11	CR7E	4578			CR7EIX	7385	0.7
	XS500/E	75→78	D9EA	2420			DR9EIX	4772	0.6
	XT500 (C/E)	77→83	BP7ES	2412			BPR7EIX	4055	0.6
530	XP500 TMAX	12→	CR7E	4578			CR7EIX	7385	0.7
535	XV535/S/DX (Virago)	88→04	BPR7ES	2023			BPR7EIX	4055	0.7
550	XJ550	81→85	D8EA	2120	DR8EVX	6354	DR8EIX	6681	0.6
	XT550	82→84	DR7ES	3123					0.7
	XZ550	82→85	DR8ES	5423			DR9EIX	4772	0.7
600	FZ600 (Air Cooled)	86→88	DR8ES-L	2923	DR8EVX	6354	DR8EIX	6681	0.7
	FZ6-S / Fazer	04→06	CR9EK	4548			CR9EIX	3521	0.7
	FZ6-S S2 / Fazer S2	07→	CR9EK	4548			CR9EIX	3521	0.7
	FZR600 (Liquid Cooled)	89→94	CR9E	6263			CR9EIX	3521	0.8
	FZR600R	94→96	CR9E	6263			CR9EIX	3521	0.8
	FZS600 Fazer	98→04	CR8E	1275			CR8EIX	4218	0.6
	SRX600	86→89	DPR7EA-9	5129			DPR7EIX-9	7803	0.9
	TT600	86→03	DPR8EA-9	4929			DPR8EIX-9	2202	0.9
	TT600RE	2004	DPR8EA-9	4929			DPR8EIX-9	2202	0.9
	XJ6 (Incl. ABS, Naked & SP)	08→16	CR9E	6263			CR9EIX	3521	0.8
	XJ6 Diversion (Incl. ABS)	08→16	CR9E	6263			CR9EIX	3521	0.8
	XJ6 Diversion F ABS	10→16	CR9E	6263			CR9EIX	3521	0.8
	XJ600	84→91	DR8ES-L	2923	DR8EVX	6354	DR8EIX	6681	0.7
	XJ600S/N (Diversion)	92→02	CR8E	1275			CR8EIX	4218	0.6
	XT600	84→88	DPR7EA-9	5129			DPR7EIX-9	7803	0.9
	XT600E	90→02	DPR8EA-9	4929			DPR8EIX-9	2202	0.9
	XT600Z Tenere	84→90	DPR7EA-9	5129			DPR7EIX-9	7803	0.9
	XT600ZE	86→91	DPR7EA-9	5129			DPR7EIX-9	7803	0.9
	YZF600R Thunder Cat	96→03	CR9E	6263			CR9EIX	3521	0.8
	YZF-R6	99→05	CR10EK	2360			CR10EIX	6482	0.7
	06→	CR10EK	2360			CR10EIX	6482	0.7	
650	XJ650	80→84	BP7ES	2412			BPR7EIX	4055	0.7
	XJ650T	82→85	BPR8ES	3923			BPR8EIX	6684	0.7
	XS2	72→73	B8ES	2411			BR8EIX	5044	0.6
	XS650 (E, SE, Special)	78→82	BP7ES	2412			BPR7EIX	4055	0.7



CC	MODEL	DATE	STANDARD COPPER CORE	STOCK NUMBER	PLATINUM OR GOLD PALLADIUM	STOCK NUMBER	IRIDIUM	STOCK NUMBER	GAP MM
YAMAHA (CONTINUED)									
650	XVS650 Drag Star	97→02	DPR7EA-9	5129			DPR7EIX-9	7803	0.9
	XVS650A Drag Star	98→06	DPR7EA-9	5129			DPR7EIX-9	7803	0.9
660	MT-03	05→12	CR7E	4578			CR7EIX	7385	0.8
	SZR660	95→97	DPR9EA-9	5329			DPR9EIX-9	5545	0.9
	XT660 R/X	04→14	CR7E	4578			CR7EIX	7385	0.8
	XT660Z Tenere	08→15	CR7E	4578			CR7EIX	7385	0.8
	XTZ660 Tenere	91→99	DPR8EA-9	4929			DPR8EIX-9	2202	0.9
689	MT-07	14→	LMAR8A-9	4313					0.9
	Tracer 700	16→	LMAR8A-9	4313					0.9
	XSR700	15→	LMAR8A-9	4313					0.9
750	FZ750	85→91	DR8ES-L	2923	DR8EVX	6354	DR8EIX	6681	0.6
	FZR750R	87→89	DR8ES-L	2923	DR8EVX	6354	DR8EIX	6681	0.6
	FZR750R OW01	89→91	DR9EA	3437			DR9EIX	4772	0.6
	FZX750	87→89	DR8ES-L	2923	DR8EVX	6354	DR8EIX	6681	0.6
	XJ750 (SECA)	82→84	BPR7ES	2023			BPR7EIX	4055	0.7
	XS750 (C, D, E, SE)	80→82	BPR7ES	2023			BPR7EIX	4055	0.7
	XTZ750 Super Tenere	89→95	DPR8EA-9	4929			DPR8EIX-9	2202	0.9
	XV750 SE	81→83	BPR7ES	2023			BPR7EIX	4055	0.7
	XV750 Virago	92→96	BPR7ES	2023			BPR7EIX	4055	0.7
	YZF750R	93→96	CR9E	6263			CR9EIX	3521	0.7
	YZF750-R7 OW02	1999					R0373A-10	4940	0.8
	YZF750SP	93→96	CR9E	6263			CR9EIX	3521	0.7
779	FZ8, Fazer8	10→	CR9E	6263			CR9EIX	3521	0.7
850	MT-09 (Incl. SP & Tracer)	13→	CPR9EA-9	2308			CR9EIX	3521	0.9
	MXT850 Niken	18→	MR9K-9	97162					0.9
	MXT850D Niken GT	19→	MR9K-9	97162					0.9
	TDM850	91→95	DPR9EA-9	5329			DPR9EIX-9	5545	0.9
	TDM850	96→01	DPR8EA-9	4929			DPR8EIX-9	2202	0.9
	Tracer 900 (Incl. GT)	16→	CPR9EA-9	2308			CR9EIX	3521	0.9
	TRX850	96→99	DPR8EA-9	4929			DPR8EIX-9	2202	0.9
	XS850	80→85	BP7ES	2412			BPR7EIX	4055	0.7
	XSR900	02/16→	CPR9EA-9	2308			CR9EIX	3521	0.9
900	TDM 900	02→10	DPR8EA-9	4929			DPR8EIX-9	2202	0.9
	XJ900F/S	83→94	BPR8ES	3923			BPR8EIX	6684	0.7
	XJ900S Diversion	95→04	DPR8EA-9	4929			DPR8EIX-9	2202	0.8
950	XV950, R	14→	CPR7EA-9	3901			CR7EIX	7385	0.9
	XVS950A Midnight Star	09→12	CPR7EA-9	3901			CR7EIX	7385	0.9
	XVS950XR SCR950	17→	CPR7EA-9	3901			CR7EIX	7385	0.9
1000	FZR1000	87→88	DR8ES-L	2923	DR8EVX	6354	DR8EIX	6681	0.7
	FZR1000 EXUP	89→93	DR8ES-L	2923	DR8EVX	6354	DR8EIX	6681	0.7
	FZR1000 EXUP	93→95	DR8EA	7162	DR8EVX	6354	DR8EIX	6681	0.8
	FZS1000 Fazer	01→05	CR9E	6263			CR9EIX	3521	0.7
	FZ-1 / Fazer	06→12	CR9EK	4548			CR9EIX	3521	0.7
	GTS1000A	93→96	DPR8EA-9	4929			DPR8EIX-9	2202	0.9
	MT-10	05/16→	LMAR9E-J	6884					0.7
	TR1	81→85	BP7ES	2412			BPR7EIX	4055	0.7
	XV1000SE	86→88	BPR7ES	2023			BPR7EIX	4055	0.7
	YZF1000R Thunderace	96→02	DR8EA	7162	DR8EVX	6354	DR8EIX	6681	0.8
	YZF-R1	98→01	CR9E	6263			CR9EIX	3521	0.7
	YZF-R1	02→03					CR9EIA-9	6289	0.9
	YZF-R1 (19mm Thread Reach)	04→08	CR9EK	4548			CR9EIX	3521	0.7
	YZF-R1SP (19mm Thread Reach)	2006	CR9EK	4548			CR9EIX	3521	0.7
	YZF-R1 (Incl. Anniversary) (26.5mm Thread Reach)	09→	LMAR9E-J	6884					0.7
1100	BT1100 Bulldog	02→06	BPR7ES	2023			BPR7EIX	4055	0.7
	FJ1100	84→85	DPR8EA-9	4929			DPR8EIX-9	2202	0.9
	XS1100 (E/S)	81→84	BP6ES	7811			BPR6EIX	6637	0.7
	XV1100 Virago	89→98	BPR7ES	2023			BPR7EIX	4055	0.7
	XVS1100/A Drag Star / Classic	99→06	BPR7ES	2023			BPR7EIX	4055	0.7
1200	FJ1200/A, XVZ12TD	86→96	DPR8EA-9	4929			DPR8EIX-9	2202	0.9
	V-Max 1200	91→02	DPR8EA-9	4929			DPR8EIX-9	2202	0.9
	XJR1200	95→98	DPR8EA-9	4929			DPR8EIX-9	2202	0.8
	XT1200Z Super Tenere (Twin Spark)	10→	CPR8EB-9	6607					0.9
	XT1200Z World Crosser (Twin Spark)	12→	CPR8EB-9	6607					0.9



CC	MODEL	DATE	STANDARD COPPER CORE	STOCK NUMBER	PLATINUM OR GOLD PALLADIUM	STOCK NUMBER	IRIDIUM	STOCK NUMBER	GAP MM
YAMAHA (CONTINUED)									
1200	XVZ12TD Venture	85→86	DPR8EA-9	4929			DPR8EIX-9	2202	0.8
1300	FJR1300/A	01→05	CR8E	1275			CR8EIX	4218	0.7
	FJR1300A/AS	06→12	CR8E	1275			CR8EIX	4218	0.7
	FJR1300A/AS	13→	CPR8EA-9	2306			CR8EIX	4218	0.9
	XJR1300/SP	99→	DPR8EA-9	4929			DPR8EIX-9	2202	0.9
	XJR1300 Racer	15→	DPR8EA-9	4929			DPR8EIX-9	2202	0.9
	XVS1300A Midnight Star	07→	LMAR7A-9	4908					0.9
	XVS1300CU Custom	14→	LMAR7A-9	4908					0.9
	XVZ1300 TF Venture Star	99→01	DPR8EA-9	4929			DPR8EIX-9	2202	0.8
	XVZ13A Royal Star	96→98	DPR7EA-9	5129			DPR7EIX-9	7803	0.9
1600	XV1600/A Wild Star	99→02	DPR7EA-9	5129			DPR7EIX-9	7803	0.9
1670	MT-01 1600 (Twin Spark)	05→08	DPR7EA-9	5129			DPR7EIX-9	7803	0.9
1679	VMAX 1700	08→					CR9EIA-9	6289	0.9
1700	XV1700 Road Star	03→08	DPR7EA-9	5129			DPR7EIX-9	7803	0.9
1900	XV1900 Midnight Star (Twin Spark)	06→13	DPR8EA-9	4929			DPR8EIX-9	2202	0.8

YAMASAKI									
125	YM125-3	11→	D8EA	2120	DR8EVX	6354	DR8EIX	6681	0.6

YIYING (SEE BENZHOU)

ZING (SEE LIFAN)

ZNEN									
125	ZN125F Firenze 125		C7HSA	4629			CR7HIX	7544	0.6

ZONGSHEN									
125	Arktix, Predator ZS125-GY10		DR8EA	7162	DR8EVX	6354	DR8EIX	6681	0.7
250	Storm ZS250GS		D8EA	2120	DR8EVX	6354	DR8EIX	6681	0.6

ATV Quad



CC	MODEL	DATE	STANDARD COPPER CORE	STOCK NUMBER	PLATINUM OR GOLD PALLADIUM	STOCK NUMBER	IRIDIUM	STOCK NUMBER	GAP MM
ADLY									
103	ATV-110 Fun bike	10→	BP7HS	5111			BPR7HIX	5944	0.7
300	ATV-300XS	07→11	DR8EA	7162	DR8EVX	6354	DR8EIX	6681	0.7
320	ATV-320S, ATV-320U	07→	CR8E	1275			CR8EIX	4218	0.7

APACHE									
50	RLX 50	08→	BR8HSA	5539			BPR8HIX	6742	0.7
	Tomahawk Mini 50 (4-Stroke)	→07	CR7HSA	4549			CR7HIX	7544	0.6
	Tomahawk Mini 50 (2-Stroke)	08→	BR8HSA	5539			BPR8HIX	6742	0.7
100	Army 100	05→	BR8HSA	5539			BPR8HIX	6742	0.6
	RLX 100	05→	BR8HSA	5539			BPR8HIX	6742	0.6
	SX 100	04→09	BR8HSA	5539			BPR8HIX	6742	0.6
	ZX100	08→09	BR8HSA	5539			BPR8HIX	6742	0.7
150	RLX 150 H	06→	CR7HSA	4549			CR7HIX	7544	0.6
	RLX 150	06→	CR7HSA	4549			CR7HIX	7544	0.6
	Superbug 150	06→	CR7HSA	4549			CR7HIX	7544	0.6
170	RLX 170 S	06→	DR8EA	7162	DR8EVX	6354	DR8EIX	6681	0.6
250	RLX 250 AX	06→08	DR8EA	7162	DR8EVX	6354	DR8EIX	6681	0.6
	RLX 250 S	06→07	CR8HS	7423			CR8HIX	7669	0.7
	RLX 250 SX	06→07	CR8HS	7423			CR8HIX	7669	0.7
280	RLX 320	07→	DPR7EA-9	5129			DPR7EIX-9	7803	0.9
360	RLX 400	10→	CR8E	1275			CR8EIX	4218	0.7
450	RLX 450	08→	CR8E	1275			CR8EIX	4218	0.7
500	RLX F500	10→	DPR7EA-9	5129			DPR7EIX-9	7803	0.9

ARCTIC CAT									
50	50	06→	CR7HSA	4549			CR7HIX	7544	0.6
90	90	06→	CR7HSA	4549			CR7HIX	7544	0.6
150	150	09→	DR8EA	7162	DR8EVX	6354	DR8EIX	6681	0.7
250	250	01→	DR7EA	7839					0.6
300	300	05→	DR7EA	7839					0.6
	DVX 300	08→	DPR7EA-9	5129			DPR7EIX-9	7803	0.9
366	400 H1	08→	CR7E	4578			CR7EIX	7385	0.7
400	400	03→	CR7E	4578			CR7EIX	7385	0.7
	DVX 400	04→08	CR7E	4578			CR7EIX	7385	0.7
500	500	97→	CR6E	6965					0.8
550	550	09→	CPR8E	7411			CR8EIX	4218	0.8
650	650	04→05	CR7E	4578			CR7EIX	7385	0.7
	650 H1	05→	CPR8E	7411			CR8EIX	4218	0.8
700	700 H1	09→	CPR8E	7411			CR8EIX	4218	0.8
	Wildcat Trail	14→	CR8EB	7784			CR8EIX	4218	0.7
950	1000 Thundercat H2	09→	CPR8E	7411			CR8EIX	4218	0.8

AUSA									
400	Task M50	04→	DCPR8E*	4179			DCPR8EIX	6546	0.7

BLAST (LEM)									
50	50		B7HS	5110			BR7HIX	7067	0.6
100	100		B7HS	5110			BR7HIX	7067	0.6

BOMBARDIER (→05)									
50	DS 50 (Rotax)	02→03	BPR7HS	6422			BPR7HIX	5944	0.6
	DS 50	04→05	BR9ECS	3570					0.7
90	DS 90 (Rotax 2-Stroke)	02→03	BPR7HS	6422			BPR7HIX	5944	0.6
	DS 90 (Rotax 2-Stroke)	04→05	BR9ECS	3570					0.7
	DS 90 (Rotax 4-Stroke)	02→	CR7HSA	4549			CR7HIX	7544	0.6
200	Rally (Rotax)	03→05	CR8E	1275			CR8EIX	4218	0.7



* Please note DCPR8E 4339 has a removable terminal nut, whereas DCPR8E 4179 has a fixed terminal nut





CC	MODEL	DATE	STANDARD COPPER CORE	STOCK NUMBER	PLATINUM OR GOLD PALLADIUM	STOCK NUMBER	IRIDIUM	STOCK NUMBER	GAP MM
BOMBARDIER (→05) (CONTINUED)									
330	Outlander 330 HO (Rotax 4-TEC)	04→05	BR9ECS	3570					0.7
400	Outlander 400 HO (Rotax 4-TEC) Ø12mm Plug	03→	DCPR8E*	4179			DCPR8EIX	6546	0.6
	Outlander 400 Ø14mm Plug	04→	BR9ECS	3570					0.7
500	Traxter (Rotax) Ø12mm Plug	98→02	DR8EA	7162	DR8EVX	6354	DR8EIX	6681	0.7
	Traxter (Rotax) Ø14mm Plug	03→	BR9ECS	3570					0.7
	Traxter CVT	2005	DCPR8E*	4179			DCPR8EIX	6546	0.7
650	DS 650 (Rotax) Ø12mm Plug	00→05	DR8EA	7162	DR8EVX	6354	DR8EIX	6681	0.7
	Quest 650 (Rotax 4-TEC) Ø12mm Plug	02→03	DR8EA	7162	DR8EVX	6354	DR8EIX	6681	0.7
	Quest 650 Ø14mm Plug	03→	BR9ECS	3570					0.7
	Traxter CVT	2005	DCPR8E*	4179			DCPR8EIX	6546	0.7

CAN-AM (BRP)									
50	DS 50	2006	BR9ECS	3570					0.7
70	DS 7	08→	CR7HSA	4549			CR7HIX	7544	0.7
90	DS 90 (Rotax 2-Stroke)	2006	BR9ECS	3570					0.7
	DS 90 (Rotax 4-Stroke)	06→	CR7HSA	4549			CR7HIX	7544	0.6
200	Rally (Rotax)	06→07	CR8E	1275			CR8EIX	4218	0.7
250	DS 250	06→	CR8E	1275			CR8EIX	4218	0.7
400	Outlander 400 HO (Rotax 4-TEC) Ø12mm Plug	06→	DCPR8E*	4179			DCPR8EIX	6546	0.6
	Outlander 400 Ø14mm Plug	06→	BR9ECS	3570					0.7
	Outlander MAX	13→	DCPR8E*	4179			DCPR8EIX	6546	0.7
450	DS 450	08→	DCPR9E	2641			DCR9EIX	6650	0.7
	Outlander L, L MAX	15→	LMAR8D-J	93444					0.8
500	Outlander 500	07→14	DCPR8E*	4179			DCPR8EIX	6546	0.7
	Outlander L, L MAX	15→	DCPR8E*	4179			DCPR8EIX	6546	0.7
	Renegade 500	08→	DCPR8E*	4179			DCPR8EIX	6546	0.7
	Traxter (Rotax) Ø14mm Plug	06→	BR9ECS	3570					0.7
570	Outlander L MAX	15→	DCPR8E*	4179			DCPR8EIX	6546	0.7
650	DS 650 (Rotax) Ø12mm Plug	06→07	DR8EA	7162	DR8EVX	6354	DR8EIX	6681	0.7
	Outlander 650	06→	DCPR8E*	4179			DCPR8EIX	6546	0.7
	Outlander 6x6	15→	DCPR8E*	4179			DCPR8EIX	6546	0.7
	Quest 650 Ø14mm Plug	06→	BR9ECS	3570					0.7
800	Commander 800	11→	DCPR8E*	4179			DCPR8EIX	6546	0.7
	Outlander 800 (Incl. R, X & XC models)	06→	DCPR8E*	4179			DCPR8EIX	6546	0.7
	Renegade 800	07→	DCPR8E*	4179			DCPR8EIX	6546	0.7
1000	Commander 1000	11→	DCPR8E*	4179			DCPR8EIX	6546	0.7
	Maverick	13→	LMAR8C-9	93833					0.9
	Outlander 6x6	15→	DCPR8E*	4179			DCPR8EIX	6546	0.7

CECTEK									
497	Gladiator	09→	CR7E	4578			CR7EIX	7385	0.7
	Quadrift	09→	CR7E	4578			CR7EIX	7385	0.7

CLUB CAR									
719	Carryall 294, 295 (Kubota D722 diesel engine)	04→	YE01	2649					-

CPI									
50	ATV 50	09→	BPR7HS	6422			BPR7HIX	5944	0.7
	XT50R	09→	BR7HS	4122			BR7HIX	7067	0.7
100	ATV 100	03→	BPR7HS	6422			BPR7HIX	5944	0.7
200	ATV 200		BR7HS	4122			BR7HIX	7067	0.7

CUB CADET									
624	Volunteer 4x4 (Kohler CH640 engine)	09→	BCPR5ES	6130			BCPR5EIX	5688	0.7
747	Volunteer 4x4 EFI (Kohler Aegis LH775 engine)	12→	BPR5E	7075			BPR5EIX	6597	0.7
854	Volunteer 4x4D (Yanmar diesel engine)		Y1021J	97627					-



* Please note DCPR8E 4339 has a removable terminal nut, whereas DCPR8E 4179 has a fixed terminal nut





CC	MODEL	DATE	STANDARD COPPER CORE	STOCK NUMBER	PLATINUM OR GOLD PALLADIUM	STOCK NUMBER	IRIDIUM	STOCK NUMBER	GAP MM
CUSHMAN									
400	Hauler 800, 1200, 1200X	16→	BPR2ES	2264					0.7
	Refresher FS2, FS4, Oasis	16→	BPR2ES	2264					0.7
	Shuttle 2, 4, 6, 8	16→	BPR2ES	2264					0.7
720	Hauler 4x4 (720cc EFI)	16→	BPR5ES	7422			BPR5EIX	6597	0.7

DINLI									
50	JP 502	04→	BPR7HS	6422			BPR7HIX	5944	0.7
110	Diablo 110	04→	BPR7HS	6422			BPR7HIX	5944	0.7
150	Diablo 150	05→07	C7HSA	4629			CR7HIX	7544	0.7
265	270 Sport	06→	DPR7EA-9	5129			DPR7EIX-9	7803	0.7
450	450 Sport	07→	DCPR8E*	4339			DCPR8EIX	6546	0.8

E-TON									
40	JXL40 Viper	03→	BPM7A	7321					0.6
	RXL40E	01→07	BPM7A	7321					0.6
50	RXL50 Viper	02→	BPR7HS	6422			BPR7HIX	5944	0.7
70	RXL70	05→	BPR7HS	6422			BPR7HIX	5944	0.7
90	DXL90 Sierra	03→	BPR7HS	6422			BPR7HIX	5944	0.7
	RXL90 R	03→07	BPR7HS	6422			BPR7HIX	5944	0.7
	RXL90 Viper	02→	BPR7HS	6422			BPR7HIX	5944	0.7
150	CXL150 Challenger	99→	C7HSA	4629			CR7HIX	7544	0.7
	EXL ST150	04→11	C7HSA	4629			CR7HIX	7544	0.7
	RXL150 Viper	09→	C7HSA	4629			CR7HIX	7544	0.7
	YXL150 Yukon	99→	C7HSA	4629			CR7HIX	7544	0.7
250	VXL250 Vector	07→	CR8E	1275			CR8EIX	4218	0.6
300	VXL-300ST Vector	10→	CR8E	1275			CR8EIX	4218	0.6

E-Z-GO									
400	Hauler 800, 1200, 1200X	16→	BPR2ES	2264					0.7
	Refresher FS2, FS4, Oasis		BPR2ES	2264					0.7
	Shuttle 2, 4, 6, 8	16→	BPR2ES	2264					0.7
	RXV Golf Kart (FJ400D engine)	16→	BPR2ES	2264					0.7
	TXT Golf Kart (FJ400D engine)	14→	BPR2ES	2264					0.7
720	Hauler 4x4 (720cc EFI)	16→	BPR5ES	7422			BPR5EIX	6597	0.7

GAS GAS									
50	Quad 50	04→07	B9ES	2611			BR9EIX	3981	0.6
250	Quad 250	07→	DPR7EA-9	5129			DPR7EIX-9	7803	0.7
300	Wild HP	03→	BR8EG	3130			BR8EIX	5044	0.5
450	Wild HP	03→	CR8E	1275			CR8EIX	4218	0.7

HONDA									
70	ATC70, ATC70-D	78→85	CR7HS	7223			CR7HIX	7544	0.7
90	TRX90 Sportrax	94→	CR6HSA	2983			CR6HIX	7274	0.6
110	ATC110	79→85	DR8HS	5123					0.7
125	ATC125M	84→87	DR8ES-L	2923	DR8EVX	6354	DR8EIX	6681	0.7
	TRX125 All variants	85→88	DR8ES-L	2923	DR8EVX	6354	DR8EIX	6681	0.7
185	ATC185S-D	79→82	DR8ES-L	2923	DR8EVX	6354	DR8EIX	6681	0.7
200	ATC200 (EC/XD/ESE)	81→84	DR8ES-L	2923	DR8EVX	6354	DR8EIX	6681	0.7
	TRX200 All variants	84→97	DR8ES-L	2923	DR8EVX	6354	DR8EIX	6681	0.7
250	ATC250R-D	81→83	BR8ES	5422			BR8EIX	5044	0.7
	ATC250R-F/G	85→86	BR9ES	5722			BR9EIX	3981	0.7
	TRX250 RH, RJ, RK	86→89	BR9ES	5722			BR9EIX	3981	0.7
	TRX250 EX Sportrax	01→08	DPR8EA-9	4929			DPR8EIX-9	2202	0.9
	TRX250 TM/TE Fourtrax S/ES	02→	DPR8EA-9	4929			DPR8EIX-9	2202	0.9



* Please note DCPR8E 4339 has a removable terminal nut, whereas DCPR8E 4179 has a fixed terminal nut





CC	MODEL	DATE	STANDARD COPPER CORE	STOCK NUMBER	PLATINUM OR GOLD PALLADIUM	STOCK NUMBER	IRIDIUM	STOCK NUMBER	GAP MM
HONDA (CONTINUED)									
300	TRX300FW-V	94→99	DPR8EA-9	4929			DPR8EIX-9	2202	0.9
	TRX300EX	00→01	DR8ES-L	2923	DR8EVX	6354	DR8EIX	6681	0.7
350	TRX350-H, J, K, L, M, N, P	86→93	DR8ES-L	2923	DR8EVX	6354	DR8EIX	6681	0.7
	TRX350 TM/TE Fourtrax S/ES	01→06	DPR7EA-9	5129			DPR7EIX-9	7803	0.9
400	TRX400AT Fourtrax	05→07	DPR8EA-9	4929			DPR8EIX-9	2202	0.9
	TRX400EX Sportrax	05→	DPR8Z	4730					0.9
420	TRX420 FE/FM/FPM/TE/TM Fourtrax ES	07→	BKR5E-11	6953			BKR5EIX-11	5464	1.1
450	TRX450 FE/FM ES/S	97→04	DPR7EA-9	5129			DPR7EIX-9	7803	0.9
	TRX450R Sportrax	04→05					IFR8H11	5068	1.1
	TRX450-ER Sportrax	06→09					IFR7L11	5114	1.1
475	TRX500 ES/FM/FE Foreman Ø14mm Plug (Manual) 475cc	05→18	BKR5E-11	6953			BKR5EIX-11	5464	1.1
	TRX500 FA Foreman Ø14mm Plug (Auto) 475cc	15→18	BKR5E-11	6953			BKR5EIX-11	5464	1.1
500	TRX500 FA1, FA2, FA3 Foreman AT Ø12mm Plug (Auto) 499cc	01→14					IJR7A9	7901	0.9
518	TRX520 Fourtrax, Foreman	19→	BKR5E-11	6953			BKR5EIX-11	5464	1.1
650	TRX650FA Rincon AT	03→05					IFR5L11	6502	1.1
675	SXS 700 M2, M4 Pioneer	18→	BKR5E-11	6953			BKR5EIX-11	5464	1.1
	TRX680FA Rincon Ø14mm Plug	05→14					IFR5L11	6502	1.1
	TRX680FA Rincon (Twin Spark) Ø10mm Plug	15→	CPR6EB-9	5958			CR6EIA-9	7967	0.9

HYMOTO									
70	HQ70		C7HSA	4629			CR7HIX	7544	0.7
110	HQ110	09→	C7HSA	4629			CR7HIX	7544	0.7
200	HQ200SRL	10→	DR8EA	7162	DR8EVX	6354	DR8EIX	6681	0.7
300	HQ300 4x4 / SRL	07→	DR8EA	7162	DR8EVX	6354	DR8EIX	6681	0.7

HYOSUNG									
50	TE50	07→	BPR6HS	7022			BPR6HIX	4085	0.7
90	TE90	07→	BPR7HS	6422			BPR7HIX	5944	0.7
100	TE100R	04→	BPR7HS	6422			BPR7HIX	5944	0.7
450	TE450 Rapier	07→	CR8E	1275			CR8EIX	4218	0.7

JOHN DEERE									
586	XUV 590i	17→					BKR6EIX-11	3764	0.8
812	XUV 825i	10→					BKR6EIX-11	3764	0.8
854	XUV 855D Gator (Yanmar 3-cyl. diesel)		Y1021J	97627					-

KAWASAKI									
50	KFX50 A	03→	BPR4HS	7823					0.7
220	KLF220 A	88→02	DR8ES	5423			DR9EIX	4772	0.7
250	KLF250	03→	DR8ES	5423			DR9EIX	4772	0.6
300	KAF300 A-C (Mule 500/550)	91→04	BPR5ES	7422			BPR5EIX	6597	0.8
	KLF300 (Ø14mm Plug)	86→88	BR8ES	5422			BR8EIX	5044	0.6
	KLF300 (Ø12mm Plug)	89→	DR8EA	7162	DR8EVX	6354	DR8EIX	6681	0.7
	KVF300	99→04	DR8EA	7162	DR8EVX	6354	DR8EIX	6681	0.7
	KVF300 Brute Force 300	12→	DPR7EA-9	5129			DPR7EIX-9	7803	0.9
360	KVF360	02→	DPR8EA-9	4929			DPR8EIX-9	2202	0.9
400	KAF400 A, B (Mule 600/610)	05→16	BPR5ES	7422			BPR5EIX	6597	0.8
	KAF400 Pro-SX	17→	BPR5ES	7422			BPR5EIX	6597	0.8
	KFX400	03→	CR7E	4578			CR7EIX	7385	0.7
	KLF400 B	93→99	DPR8EA-9	4929			DPR8EIX-9	2202	0.9
	KVF400	99→	DPR8EA-9	4929			DPR8EIX-9	2202	0.9
450	KAF450 (Mule 1000)	88→	D6EA	7512					0.7
	KFX450R	08→	CPR8EB-9	6607			CR8EIX	4218	0.9
540	KAF540 C (Mule 2010)	02→05	BP5ES	6511			BPR5EIX	6597	0.5
620	KAF620-A (Mule 2510 - 4 Wheel drive)	92→00	BMR2A	7677					0.7
	KAF620-C (Mule 2500 - 2 Wheel drive)	93→00	BMR2A	7677					0.7
	KAF620-D (Mule 2500E - 2 Wheel drive) Road version	93→96	BMR4A	5728					0.7
	KAF620-E (Mule 3010 - 4 Wheel drive)	01→06	BPR2ES	2264					0.7
	KAF620-G (Mule 3000 - 2 Wheel drive)	01→06	BPR2ES	2264					0.7



CC	MODEL	DATE	STANDARD COPPER CORE	STOCK NUMBER	PLATINUM OR GOLD PALLADIUM	STOCK NUMBER	IRIDIUM	STOCK NUMBER	GAP MM
KAWASAKI (CONTINUED)									
650	KVF650	02→	CR7E	4578			CR7EIX	7385	0.7
700	KAF700 Pro-MX	19→	CR7E	4578			CR7EIX	7385	0.7
	KFX700 V Force	04→	CR7E	4578			CR7EIX	7385	0.7
	KVF700 A	04→	CR7E	4578			CR7EIX	7385	0.7
750	KVF750 A-D	05→13	CR7E	4578			CR7EIX	7385	0.7
	KVF750 Brute Force 750	2014	CR7E	4578			CR7EIX	7385	0.7
	KVF750 Brute Force 750	15→	CPR7EA-9	3901			CR7EIX	7385	0.9
950	KAF950 A-D Diesel (Mule 2510, 3010)	98→08	Y-706R	3041					-
	KAF950 F-H Diesel (Mule 4010)	09→13	Y-601J	92785					-

KAZUMA									
50	Meerkat	08→	C7HSA	4629			CR7HIX	7544	0.6
90	Falcon	05→	C7HSA	4629			CR7HIX	7544	0.6
110	Baby Falcon, Falcon, Panda Lacoste	05→	C7HSA	4629			CR7HIX	7544	0.6
150	Dingo, Falcon	03→	C7HSA	4629			CR7HIX	7544	0.6
500	Jaguar	07→	BKR6E	6962			BKR6EIX	6418	0.7
800	Mammoth	07→	BPR6ES	7822			BPR6EIX	6637	0.6

KTM									
450	450 SX (Ø10mm Plug)	09→	CR9EKB	2305			CR9EIX	3521	0.8
	450 XC (Ø12mm Plug)	08→	DCPR8E*	4179			DCPR8EIX	6546	0.6
477	505 SX (Ø10mm Plug)	09→	CR9EKB	2305			CR9EIX	3521	0.8
510	525 XC (Ø12mm Plug)	08→	DCPR8E*	4179			DCPR8EIX	6546	0.6

KUBOTA									
400	RTV400Ci	13→	BR6HS	3922			BR6HIX	3419	0.6
500	RTV500	13→					BKR4EIX	5693	0.7
898	RTV900 Diesel	04→	YE01	2649					-
1123	RTV1100 Diesel	07→	YE01	2649					-
	RTV1140 Diesel	09→	YE01	2649					-

KYMCO									
50	KXR 50		BR8HSA	5539			BPR8HIX	6742	0.6
90	KXR 90		C7HSA	4629			CR7HIX	7544	0.7
150	MXer 150 /RL	01→	DR8EA	7162	DR8EVX	6354	DR8EIX	6681	0.7
	MXU 150 RL	05→	DR8EA	7162	DR8EVX	6354	DR8EIX	6681	0.7
250	KXR 250 /RL	01→	DPR7EA-9	5129			DPR7EIX-9	7803	0.9
	MXU 250 RL, Maxxer 250		DPR7EA-9	5129			DPR7EIX-9	7803	0.9
300	MXU 300 RL, Maxxer 300	05→	DPR7EA-9	5129			DPR7EIX-9	7803	0.9
400	MXU 400		CR8E	1275			CR8EIX	4218	0.7
443	MXU 450i	12→	CR7E	4578			CR7EIX	7385	0.6
500	MXU 500	→11	CR7E	4578			CR7EIX	7385	0.6
	MXU 500i IRS	12→	CR7E	4578			CR7EIX	7385	0.6
	UXV 500		CR7E	4578			CR7EIX	7385	0.9

LEM									
50	Beetlebug, Cayman, Condor	97→	B7HS	5110			BR7HIX	7067	0.6

MASAI									
265	A300	05→	DCPR7E	3932			DCPR7EIX	6046	0.8
450	A450	05→	DCPR8E*	4179			DCPR8EIX	6546	0.6



* Please note DCPR8E 4339 has a removable terminal nut, whereas DCPR8E 4179 has a fixed terminal nut





CC	MODEL	DATE	STANDARD COPPER CORE	STOCK NUMBER	PLATINUM OR GOLD PALLADIUM	STOCK NUMBER	IRIDIUM	STOCK NUMBER	GAP MM
MASSEY FERGUSON									
250	MF250 2WD	06→08	DR7EA	7839					0.6
350	MF350MRP 4WD Manual 5 Speed	06→08	DR7EA	7839					0.6
400	MF400MRP 4WD Manual 5 Speed	06→08	CR6E	6965					0.8
450	MF450MRP 4WD Automatic	06→08	CR6E	6965					0.8
500	MF500MRP 4WD Automatic & Manual 5 Speed	06→08	CR6E	6965					0.8
	MF500TBX 4WD Automatic	06→08	CR6E	6965					0.8

MOTO ROMA									
50	Blazer 50		B8HS	5510			BR8HIX	7001	0.5
	Blazer 50DL		BP7HS	5111			BPR7HIX	5944	0.6
90	Sport 90		BP7HS	5111			BPR7HIX	5944	0.7
100	Blazer 100		BP7HS	5111			BPR7HIX	5944	0.5
	Roadrunner 4	04→	BP7HS	5111			BPR7HIX	5944	0.6
	Sport 100		BP7HS	5111			BPR7HIX	5944	0.6
125	Sportsman 125	03→	C7HSA	4629			CR7HIX	7544	0.6
	SS Buggy (AB125E,R)		C7HSA	4629			CR7HIX	7544	0.6
150	DS Buggy (AB150IIR)		C7HSA	4629			CR7HIX	7544	0.6
	Sport/Sportsman 150		C7HSA	4629			CR7HIX	7544	0.6
	X Machine		C7HSA	4629			CR7HIX	7544	0.6
250	Sport 250		C7HSA	4629			CR7HIX	7544	0.6
	Sportsman 250		C7HSA	4629			CR7HIX	7544	0.6
282	Geko 300	05→	DR8EA	7162	DR8EVX	6354	DR8EIX	6681	0.7

POLARIS									
50	Predator 50	03→	BPR7HS	6422			BPR7HIX	5944	0.6
90	Predator 90	03→	BPR7HS	6422			BPR7HIX	5944	0.6
	Sportsman 90		BPR7HS	6422			BPR7HIX	5944	0.6
200	Phoenix 200	05→	CR6HSA	2983			CR6HIX	7274	0.7
	Sawtooth	06→	CR7HSA	4549			CR7HIX	7544	0.7
250	Trail Blazer 250		BR8ES	5422			BR8EIX	5044	0.7
300	Hawkeye 300 2x4, 4x4	06→	CR8EB	7784			CR8EIX	4218	0.8
330	Magnum 330		BKR6E	6962			BKR6EIX	6418	0.9
	Trail Boss 330		BKR6E	6962			BKR6EIX	6418	0.9
400	Sportsman 400 H.O.	09→	BKR6E	6962			BKR6EIX	6418	0.9
450	Sportsman 450		BKR6E	6962			BKR6EIX	6418	0.9
500	Predator 500	05→	DCPR8E*	4339			DCPR8EIX	6546	0.9
	Predator Troy Lee	06→	DCPR8E*	4339			DCPR8EIX	6546	0.9
	Ranger 4x4 EFI		BKR6E	6962			BKR6EIX	6418	0.9
	Scrambler 500		BKR6E	6962			BKR6EIX	6418	0.9
	Sportsman 500 EFI		BKR6E	6962			BKR6EIX	6418	0.9
	Sportsman 500 H.O. EFI (Incl. Touring)	09→	BKR6E	6962			BKR6EIX	6418	0.9
570	Sportsman 570EFI	13→	MR7F	95897					0.8
650	Ranger TM	06→	BPR5ES	7422			BPR5EIX	6597	0.9
680	Ranger 6x6 EFI		BKR7E	6097			BKR7EIX	2667	0.9
	Ranger XP		BKR7E	6097			BKR7EIX	2667	0.9
700	Sportsman 700 EFI		BKR7E	6097			BKR7EIX	2667	0.9
	Sportsman 700 Twin		BKR7E	6097			BKR7EIX	2667	0.9
800	RZR 800 EFI	07→14	BKR7E	6097			BKR7EIX	2667	0.9
	RZR S 800 EFI	09→14	BKR7E	6097			BKR7EIX	2667	0.9
	Sportsman 800 EFI	05→14	BKR7E	6097			BKR7EIX	2667	0.9
850	Sportsman XP 850	→09	LKAR8A-9	4786					0.9
	Sportsman XP 850	09→11	LZKAR7B	5942			ILKAR7J7G	91121	0.9
	Sportsman XP 850	12→	LKAR8A-9	4786					0.9
875	Ranger RZR 900	14→	MR7F	95897					0.8
	Ranger RZR 4 XP 900	14→	MR7F	95897					0.8
925	RZR XP Turbo	15→16	MR8F	90299					0.8
	RZR XP Turbo	17→	MR9F	95424					0.8



* Please note DCPR8E 4339 has a removable terminal nut, whereas DCPR8E 4179 has a fixed terminal nut





CC	MODEL	DATE	STANDARD COPPER CORE	STOCK NUMBER	PLATINUM OR GOLD PALLADIUM	STOCK NUMBER	IRIDIUM	STOCK NUMBER	GAP MM
PUZEY									
125	Madix 125	13→	DR8EA	7162			DR8EIX	6681	0.7

QUADZILLA									
50	Buzz	03→07	BPR7HS	6422			BPR7HIX	5944	0.6
	PGO 50E Bugrider		BPR7HS	6422			BPR7HIX	5944	0.6
100	M100		BP7HS	5111			BPR7HIX	5944	0.7
	ProShark	04→	BP8ES	2912			BPR8EIX	6684	0.6
	ProShark E		BR8HSA	5539			BPR8HIX	6742	0.6
	ProShark Type R		BP8ES	2912			BPR8EIX	6684	0.6
	R100		BPR7HS	6422			BPR7HIX	5944	0.6
	X100 Single piece head (12.7mm Thread Reach)		BR8HSA	5539			BPR8HIX	6742	0.6
	X100 Twin piece head (19mm Thread Reach)		BP8ES	2912			BPR8EIX	6684	0.6
150	PGO 150E Bugrider		CR7HSA	4549			CR7HIX	7544	0.6
165	R170E Stinger	03→06	DR8EA	7162	DR8EVX	6354	DR8EIX	6681	0.7
200	200E 4 Cross		DR8EA	7162	DR8EVX	6354	DR8EIX	6681	0.7
	ST200E	06→07	CR7HSA	4549			CR7HIX	7544	0.6
250	PGO 250E Bugrider		DPR7EA-9	5129			DPR7EIX-9	7803	0.9
	R250E Stinger		CR8HS	7423			CR8HIX	7669	0.7
	R250E Triple Disc		CR8HS	7423			CR8HIX	7669	0.7
	XRV 250	06→07	DPR7EA-9	5129			DPR7EIX-9	7803	0.9
300	300E SUV 4 Valve		DR8EA	7162	DR8EVX	6354	DR8EIX	6681	0.7
500	XLC500	08→	DCPR8E*	4339			DCPR8EIX	6546	0.9
700	RS7	10→	CR6E	6965					0.8
750	RS8	11→	CR6E	6965					0.8

QUANTUM									
150	Dingo, Falcon		C7HSA	4629			CR7HIX	7544	0.6
500	NF500L		BKR6E	6962			BKR6EIX	6418	0.7

SKYTEAM									
50	LX50ST-C		CR7HSA	4549			CR7HIX	7544	0.6
200	ST200 Quad		DR8EA	7162	DR8EVX	6354	DR8EIX	6681	0.7

STORM									
110	Panther	12→	CR7HSA	4549			CR7HIX	7544	0.6

SUZUKI									
50	LT50 →K4/K5 (Ø14mm Plug)	→05	BPR4HS	7823					0.7
	LT-A50 →K4/K5 (Ø14mm Plug)	→05	BPR4HS	7823					0.7
	LT-Z50 K5/K6 (Ø10mm Plug)	05→	CR6HSA	2983			CR6HIX	7274	0.7
80	LT80 P-R-S		BP7HS	5111			BPR7HIX	5944	0.7
	LT80 T-V-W-X-Y K1-K5		BPR7HS	6422			BPR7HIX	5944	0.7
90	LT-Z90	06→	CR6HSA	2983			CR6HIX	7274	0.7
250	LT-4WD	87→98	DR7ES	3123					0.7
	LT-F250F Ozark	99→02	DR7EA	7839					0.6
	LT-F250	03→	DR7EA	7839					0.6
	LT-Z250 K4-K5	04→	DR7EA	7839					0.6
300	LT-F300F	99→02	DR7EA	7839					0.7
400	LT-A400F K2 (Eiger)	02→	CR7E	4578			CR7EIX	7385	0.7
	LT-F400 Eiger 2WD		CR7E	4578			CR7EIX	7385	0.7
	LT-F400F Eiger 4WD	02→09	CR7E	4578			CR7EIX	7385	0.7
	LT-F400FSi KingQuad	10→13	CR7E	4578			CR7EIX	7385	0.7
	LT-F400FSi KingQuad	14→					CR7EIA-9	91175	0.9
	LT-Z400	03→13	CR7E	4578			CR7EIX	7385	0.7
450	LT-A450X	07→10	CR6E	6965			CR6EIA-9	7967	0.8
	LT-R450	06→	CR8EB	7784			CR8EIX	4218	0.7



* Please note DCPR8E 4339 has a removable terminal nut, whereas DCPR8E 4179 has a fixed terminal nut





CC	MODEL	DATE	STANDARD COPPER CORE	STOCK NUMBER	PLATINUM OR GOLD PALLADIUM	STOCK NUMBER	IRIDIUM	STOCK NUMBER	GAP MM
SUZUKI (CONTINUED)									
500	LT-A500XP KingQuad (19mm Thread Reach)	10→14	CR6E	6965			CR6EIA-9	7967	0.8
	LT-A500XP KingQuad (Twin Spark) (26.5mm Thread Reach)	15→	LMARGA-9	5946					0.9
	LT-F500F	98→07	CR7E	4578			CR7EIX	7385	0.7
700	LT700A K5-K6	05→06	CR6E	6965					0.8
	LT-A700X K7	2007	CR6E	6965			CR6EIA-9	7967	0.8
722	LT-A750X (19mm Thread Reach)	08→13	CR6E	6965			CR6EIA-9	7967	0.8
	LT-A750X (Twin Spark) (26.5mm Thread Reach)	14→	LMAR7A-9	4908					0.9

SYM									
200	TrackRunner 200	06→	CR8HSA	2086			CR8HIX	7669	0.6
250	QuadLander 250	06→	BR8HSA	5539			BPR8HIX	6742	0.6

TGB									
90	Hornet 90		BPR7HS	6422			BPR7HIX	5944	0.6
250	Blade 250		CR8E	1275			CR8EIX	4218	0.8
287	Blade 325 SL 2WD		CR8E	1275			CR8EIX	4218	0.8
	Target 325 SL 2WD		CR8E	1275			CR8EIX	4218	0.8
403	Blade 425 SL 4WD	10→	CR7E	4578			CR7EIX	7385	0.7
	Blade 450 SE IRS 4WD	10→	CR7E	4578			CR7EIX	7385	0.7
460	Blade 460 R 2WD	12→	CR7E	4578			CR7EIX	7385	0.7
503	Blade 550 LT 4WD	11→	CR7E	4578			CR7EIX	7385	0.7
	Blade 550 SE IRS 4WD	11→	CR7E	4578			CR7EIX	7385	0.7
	Target 550 IRS 4WD	11→	CR7E	4578			CR7EIX	7385	0.7

YAMAHA									
50	YFM50 Mini Raptor	03→05	CR7HS	7223			CR7HIX	7544	0.6
	YFM50 Mini Raptor	06→	CR7HSA	4549			CR7HIX	7544	0.7
60	YT60L (Tri-Moto)		BP6HS	4511			BPR6HIX	4085	0.6
80	YFM80	92→03	CR7HS	7223			CR7HIX	7544	0.7
	YFM80 Badger	04→	CR7HSA	4549			CR7HIX	7544	0.7
	YFM80 Raptor	06→	CR7HSA	4549			CR7HIX	7544	0.7
125	YFA1 Breeze	90→03	CR7HS	7223			CR7HIX	7544	0.7
	YFA1 Breeze	04→	CR7HSA	4549			CR7HIX	7544	0.7
	YFM125S Grizzly	04→	CR7HSA	4549			CR7HIX	7544	0.7
200	YTM200EL Yamahauler	1984	D7EA	7912					0.7
	YFM200N (Moto-4)	85→90	D7EA	7912					0.6
	YFS200 Blaster	88→	BR8ES	5422			BR8EIX	5044	0.6
	YTM200EK (Tri-Moto)		D7EA	7912					0.6
215	G1A Utility/Golf Kart	79→	BP5HS	4111					0.7
225	YFM225		DR7ES	3123					0.6
230	YFU1 Pro Hauler	89→90	DR7EA	7839					0.7
250	YFB250 Timberwolf 2WD/4WD	92→97	DR7EA	7839					0.6
	YFM250	88→90	DR7EA	7839					0.7
	YFM250X Bear Tracker	99→04	DR7EA	7839					0.7
	YFM250 Bear Tracker	05→	DR7EA	7839					0.6
	YFM250B Bruin/Big Bear	05→	DR7EA	7839					0.6
	YFM250R Raptor	08→	DR7EA	7839					0.6
	YTZ250	85→88	B8ES	2411			BR8EIX	5044	0.7
285	G2A, G5A, G8A, G9A Utility/Golf Kart	85→	BR4ES	1097					0.8
	G3A Utility/Golf Kart	86→	BP5HS	4111					0.7
287	YFM30GB Grizzly	12→	CR8E	1275			CR8EIX	4218	0.8
350	Drive2 EFi, Drive2 Carb	17→	BPR2ES	2264					0.7
	G23A Utility/Golf Kart	03→06	BPR2ES	2264					0.7
	YFM350 Big Bear 2WD		DR8ES-L	2923	DR8EVX	6354	DR8EIX	6681	0.6
	YFM350 Big Bear 4WD	87→93	DR8ES-L	2923	DR8EVX	6354	DR8EIX	6681	0.6
	YFM350 Big Bear 4WD	94→97	DR8EA	7162	DR8EVX	6354	DR8EIX	6681	0.8
	YFM350A, FWA Bruin 2WD/4WD	03→	DR8EA	7162	DR8EVX	6354	DR8EIX	6681	0.8
	YFM350ER	93→95	DR8ES	5423			DR9EIX	4772	0.7
	YFM350FWB	97→01	DR8EA	7162	DR8EVX	6354	DR8EIX	6681	0.7
YFM350FX Wolverine	95→99	DR8EA	7162	DR8EVX	6354	DR8EIX	6681	0.7	

ATV Quad



CC	MODEL	DATE	STANDARD COPPER CORE	STOCK NUMBER	PLATINUM OR GOLD PALLADIUM	STOCK NUMBER	IRIDIUM	STOCK NUMBER	GAP MM
YAMAHA (CONTINUED)									
350	YFM350R Raptor	05→	DR8EA	7162	DR8EVX	6354	DR8EIX	6681	0.8
	YFM350U	96→01	DR8EA	7162	DR8EVX	6354	DR8EIX	6681	0.7
	YFM350X Warrior	87→04	DR8EA	7162	DR8EVX	6354	DR8EIX	6681	0.8
	YFZ350 Banshee	87→	BR8ES	5422			BR8EIX	5044	0.6
360	G27A U-Max Utility/Golf Kart	04→06	BPR2ES	2264					0.7
	G29A	10→	BPR2ES	2264					0.7
	YDR-A (The DRIVE)	07→	BPR2ES	2264					0.7
	YTF2	10→	BPR2ES	2264					0.7
400	YFM400 Big Bear Professional Manual	00→06	DR8EA	7162	DR8EVX	6354	DR8EIX	6681	0.7
	YFM40 Big Bear Manual	07→	DR8EA	7162	DR8EVX	6354	DR8EIX	6681	0.7
	YFM400FWE Kodiak	1993	DR8ES-L	2923	DR8EVX	6354	DR8EIX	6681	0.7
	YFM400 Kodiak Manual	94→99	DR8EA	7162	DR8EVX	6354	DR8EIX	6681	0.7
	YFM400 Kodiak Auto	00→05	DR8EA	7162	DR8EVX	6354	DR8EIX	6681	0.7
	YFM4FAV Kodiak Auto	2006	DR8EA	7162	DR8EVX	6354	DR8EIX	6681	0.7
450	YFM450F Kodiak	03→05	DR8EA	7162	DR8EVX	6354	DR8EIX	6681	0.8
	YFM45 Kodiak	2006	DR8EA	7162	DR8EVX	6354	DR8EIX	6681	0.8
	YFM45 Grizzly	07→	DR8EA	7162	DR8EVX	6354	DR8EIX	6681	0.8
	YFM45 Grizzly EPS	10→	DR8EA	7162	DR8EVX	6354	DR8EIX	6681	0.8
	YFZ450	03→	CR8E	1275			CR8EIX	4218	0.8
	YFZ450R	09→	CR8E	1275			CR8EIX	4218	0.8
558	YFM550FWAD Grizzly	08→	LMAR6A-9	5946					0.9
600	YFM600FWA Grizzly	98→01	DPR8EA-9	4929			DPR8EIX-9	2202	0.9
660	YFM660FWA Grizzly	02→	DPR8EA-9	4929			DPR8EIX-9	2202	0.9
	YFM660R Raptor	01→05	DPR8EA-9	4929			DPR8EIX-9	2202	0.9
	YXR660 Rhino	04→07	DPR8EA-9	4929			DPR8EIX-9	2202	0.9
686	YXM700PE Viking	14→	CPR7EA-9	3901			CR7EIX	7385	0.8
700	YXR70FX Rhino Fi	08→	CPR7EA-9	3901			CR7EIX	7385	0.8
	YFM700R Raptor	06→	CR8E	1275			CR8EIX	4218	0.6
	YFM700 Grizzly Fi (19mm Thread Reach)	07→08	CPR7EA-9	3901			CR7EIX	7385	0.9
	YFM700FWAD Grizzly Fi (26.5mm Thread Reach)	09→13	LMAR6A-9	5946					0.9
	YFM700FWA Grizzly 700 EPS (19mm Thread Reach)	14→	CPR7EA-9	3901			CR7EIX	7385	0.9

CONVERSION CHART

IMPORTANT:

This chart is furnished as a guide only. Certain design differences may exist between our spark plugs and another manufacturers; heat ratings can also vary. Always refer to the main application data to select the recommended spark plug for specific engines.

AC DELCO	NGK → STOCK No.	AC DELCO	NGK → STOCK No.	AC DELCO	NGK → STOCK No.	AC DELCO	NGK → STOCK No.				
12620540	ILTR5D	5476	B4031	B4	3210	FR3LSK	BKR5E	7938	R44CXL	BR6ES	4922
40TS	BP7FS	3612	B43	B6S	3510	FR4LE	ZFR4F-11	4043	R44CXLS	BPR5ES	7422
41-108	ILTR5D	5476	B44S	BP5S	3011	FR5LS	BCPR5ES	6130	R44F	BR5HS	3722
41-2XLS	BP7ES	2412	B45	B4	3210	LM46	B4LM	3410	R44LTS	BPR5EFS	2223
41-4XLS	BP6ES	7811	C42-1	B6S	3510	LM49	B4LM	3410	R44N	BR6ES	4922
41-932	PTR5D-13	6644	C42CFS	BP6HS	4511	M40FFX	B9HS-10	3626	R44NS	BPR5ES	7422
41-933	PTR4B-15	5146	C42CLTS	BP6EFS	3812	M41FF	B8HS	5510	R44S	BP5S	3011
41-950	PTR5C-13	7740	C42CXLS	BP6ES	7811	M41K	B8S	3810	R44T	BR5FS	4123
41-983	PZTR5A-15	7862	C42LTS	BP6EFS	3812	M42FF	B7HS	5110	R44TS	BPR5FS	2423
41-993	PTR4B-15	5146	C42N	B7ES	1111	M42K	B7S	3710	R44TSX	BPR5FS-15	3124
41TS	BP6FS	3512	C42XLS	BP5ES	6511	M43FF	B6HS	4510	R44XL	BR6ES	4922
41XL	B9ES	2611	C43	B6S	3510	M44C	B6S	3510	R44XLS	BPR5ES	7422
41XLS	BP7ES	2412	C43CXLS	BP6ES	7811	M44L	B6L	3212	R44XLSE	ZGR5C	6334
420Z	B4H	4110	C43L	B6L	3212	M45	B4	3210	R44XLSM	ZGR5C	6334
422Z	B5HS	4210	C43N	B6ES	7310	M45FF	B5HS	4210	R45NS	BPR5ES	7422
425Z	B6HS	4510	C44	B6S	3510	M47	B4	3210	R45NSX	BPR5ES-13	3154
426FS	BP6HS	4511	C44N	B6ES	7310	MB42K	B6S	3510	R45S	BP5S	3011
42F	B6HS	4510	C44NS	BP5ES	6511	MR42K	BR6S	3522	R45T	BR5FS	4123
42FS	BP6HS	4511	C44S	BP5S	3011	MR43LTS	BPR6EFS	3623	R45TS	BPR4FS	1127
42TS	BP6FS	3512	C44XL	B6ES	7310	MR43T	BR6FS	4323	R45TSX	BPR4FS-15	2727
42XL	B8ES	2411	C45	B4	3210	MR44C	BR6S	3522	R45XL	BR6ES	4922
42XLS	BP6ES	7811	C45L	B4L	3112	MR44T	BR5FS	4123	R45XLS	BPR5ES	7422
42ZZ	B6HS	4511	C49	B2	3110	R41-5TS	BPR6FS	2623	R46	BR6S	3522
430Z	B7HS	5110	C73	G2Z	3320	R41CF	BR7HS	4122	R46LTS	BPR5EFS	2223
436XLS	BP9ES	7526	C75	G2Z	3320	R41CXL	BR9ES	5722	R46N	BR5ES	4722
438XL	B8ES	2411	C81	AB8	7909	R41CXLS	BPR7ES	2023	R46S	BP4	2911
438XLS	BP8ES	2912	C82	AB7	3010	R41TS	BPR6FS	2623	R46T	BR5FS	4123
43FS	BP6HS	4511	C83	AB7	3010	R42-5LTS	BPR6EFS	3623	R46TS	BPR4FS	1127
43N	B7ES	1111	C86	AB6	2910	R42-5TS	BPR6FS	2623	R46TSX	BPR4FS-15	2727
43TS	BP6FS	3512	C87	AB6	2910	R42-6FS	BPR6HS	7022	R46XL	BR5ES	4722
43XL	B7ES	1111	C88	AB2	3020	R42CF	BR6HS	3922	R46XLS	BPR4ES	7222
43XLS	BP6ES	7811	C88L	AB2	3020	R42CFS	BPR6HS	7022	R47S	BP4	2911
44	B6S	3510	CFR1CLS	BCPR7ES	3330	R42CLTS	BPR6EFS	3623	R83CTS	APR6FS	2922
44.5V	B6S	3510	CFR2CLS	BKR6E	6962	R42CT	BR6FS	4323	R83TS	APR6FS	2922
440T	B7FS	3027	CR42CFS	BPR6FS	2623	R42CTS	BPR6FS	2623	R84TS	APR5FS	3122
440XLS	BP8ES	2912	CR42CXLS	BPR6ES	7822	R42CXL	BR8ES	5422	R85TS	APR5FS	3122
445Z	B8HS	5510	CR42N	BR7ES	5122	R42CXLS	BPR6ES	7822	S102F	C7HSA	4629
44F	B5HS	4210	CR43	BR6S	3522	R42FS	BPR6HS	7022	S104F	C6HSA	3228
44FF	B5HS	4210	CR43CXLS	BPR6ES	7822	R42LTS	BPR6EFS	3623	S121F	D8HA	7112
44FFS	BP5HS	4111	CR43K	BR6S	3522	R42T	BR6FS	4323	S121XL	D8EA	2120
44N	B6ES	7310	CR43N	BR6ES	4922	R42TS	BPR6FS	2623	S122F	D8HA	7112
44NS	BP5ES	6511	CR43TS	BPR5FS-11	2924	R42TSM	BPR6FS	2623	S123XL	D7EA	7912
44S	BP5S	3011	CR43TSM	BPR5FS-11	2924	R42XL	BR8ES	5422	S124FS	D6HA	6512
44TS	BP5FS	3412	CR44N	BR6ES	4922	R42XLS	BPR6ES	7822	S404XLG	B10EG	3630
44XL	B6ES	7310	CR44NS	BPR5ES	7422	R42XLSM	ZGR5C	6334	S408XLG	B9EG	3530
44XLO	BP5ES	6511	CR44TS	BPR5FS-11	2924	R43	BR6S	3522	S40F	B9HS	5810
44XLS	BP5ES	6511	CR45TS	BPR5FS	2423	R43C	BR6S	3522	S40FR	BR9HS	4522
45	B4	3210	CS40	BM7A	6521	R43CFS	BPR6HS	7022	S40XLG	B9ECS	7058
45F	B5HS	4210	CS41	BM7A	6521	R43CT	BR6FS	4323	S40XLR	BR8ES	5422
45FFS	BP5HS	4111	CS41T	BM7F	6421	R43CTS	BPR6FS	2623	S41F	B8HS	5510
45L	B4L	3112	CS42	BM7A	6521	R43CTS6	BPR6FS	2623	S41FR	BR8HS	4322
45NS	BP5ES	6511	CS42S	BM7A	6521	R43CXL	BR7ES	5122	S41XL	B9ES	2611
45S	BP5S	3011	CS42T	BM6F	6221	R43CXLS	BPR6ES	7822	S41XLG	B8ECS	2821
45XL	B6ES	7310	CS45	BM6A	5921	R43FS	BPR6HS	7022	S41XLR	BR9ES	5722
45XLS	BP5ES	6511	CS45T	BM6F	6221	R43LTS	BPR6EFS	3623	S42	B7S	3710
46	B4	3210	CS49	BM4A	5628	R43N	BR7ES	5122	S42F	B7HS	5110
46F	B5HS	4210	CSR45	BMR6A	7421	R43T	BR6FS	4323	S42FR	BR7HS	4122
46FFS	BP5HS	4111	FR2LS	BKR6E	6962	R43TS	BPR6FS	2623	S42XL	B8ES	2411
46N	B5ES	6410	FR2LSK	BKR6E	6962	R43TSK	BPR6FS	2623	S42XLR	BR8ES	5422
46S	BP5S	3011	FR3CLS	BKR5E	7938	R43TSX	BPR6FS	2623	S43XL	B7ES	1111
46XL	B5ES	6410	FR3CLS6	BKR5E-11	6953	R43XL	BR7ES	5122	S43XLR	BR7ES	5122
47XL	B4ES	4129	FR3LM	ZFR5A-11	5084	R43XLS	BPR6ES	7822	S44	B6S	3510
83CTS	AP6FS	2710	FR3LS	BKR5E	7938	R44	BR6S	3522	S44F	B5HS	4210
83TS	AP6FS	2710	FR3LS6	BKR5E-11	6953	R44CF	BR5HS	3722	S44XL	B6ES	7310

AC DELCO	NGK → STOCK No.		APRILIA	NGK → STOCK No.		AUTOLITE	NGK → STOCK No.		AUTOLITE	NGK → STOCK No.	
S45F	B5HS	4210	0897055	BR8ES	5422	218	B4L	3112	517	BP4HS	3611
S46	B4	3210	2BEN000088	BPR8HS	3725	235	BM6A	5921	536	B4H	4110
S81F	AB8	7909	2BEN000181	CPR8E	7411	245	BMR6A	7421	664	BPR6FS	2623
S82F	AB8	7909	8122586	DR7EA	7839	253	BM7A	6521	665	BPR5FS-15	3124
S83F	AB7	3010	8206870	BR7HS	4122	254	BM6A	5921	666	BPR4FS-15	2727
S85F	AB6	2910	8206871	BR8HS	4322	255	BM6A	5921	667	BPR4FS-15	2727
SB41	B7S	3710	8550352	CR7E	4578	258	BM4A	5628	723	BPR6FS	2623
SV41XL	BUE	2322	8600008	BR9ECM	3252	273	BP6HS	4511	724	BPR6FS	2623
V40FFK	BUHW-2	5626				274	BP6HS	4511	725	BPR5FS-11	2924
V40FFM	BUHW	2622				275	BP5HS	4111	726	BPR4FS	1127
V40FFS	BUH	2422	ASTON MARTIN NGK → STOCK No.			276	BP5HS	4111	727	BPR4FS-11	2527
VB40FFM	BUHXW-1	5526	021-007-0145	C7HSA	4549	283	BPR7HS	6422	744	APR5FS	3122
VR40FFK	BUZHW-2	2173	048-007-0149	BPR6ES	7822	284	BPR6HS	7022	746	APR5FS	3122
VR40FFM	BUZHW	2147	07-14641	BPR5EIX	6597	292	B8S	3810	747	APR5FS	3122
			07-20987	BPR6EY	6427	294	B6S	3510	764	BPR6EFS	3623
			07-21106	BPR7EIX	4055	295	B4	3210	765	BPR5EFS	2223
ACTIVE	NGK → STOCK No.		07-21300	BPR8EIX	6684	297	B4	3210	766	BPR5EFS	2223
AX80	BM6A	5921	07-22846	BPR8ES	3923	298	B2	3110	865	BPR5EFS	2223
AX70	BPM6A	7021	07-23116	BCPR6E	1269	302	BR6S	3522	915	ZGR5C	6334
RAX90	BR2LM	5798	07-26330	BP6ES	7811	303	BR6S	3522	925	ZGR5C	6334
RAX80	BMR6A	7421	07-38800	BCPR7E	1272	304	BR6S	3522	935	BPR5ES	7422
MR80	CMR5H	7599	07-70920	BCR8ES	5430	306	B4	3210	945	BPR5ES	7422
						308	B2	3110	996	B6L	3212
						312	B8S	3810	2413	B10EGP	5224
ALFA ROMEO	NGK → STOCK No.		AUDI - See VW GROUP			313	B7S	3710	2414	B10EG	3630
4644 9690	BKR6EKPA	2513				314	B6S	3510	2415	B9EG	3530
5518 2623	FR5CP	6368	AUTOLITE	NGK → STOCK No.		315	B6S	3510	2416	B8EG	3430
5519 0788	ZKR7A-10	1691	12	BP7FS	3612	316	B6S	3510	2417	B7ECS	2528
5521 0685	IKR9J8	93311	13	BP6FS	3512	317	B4	3210	2585	BPR5ES	7422
5521 7232	ILKAR7D6G	93607	14	BP6FS	3512	318	B2	3110	2593	B9ES	2611
5524 9868	IKR9J8	93311	15	BP5FS	3412	353	B8S	3810	2612	B9ES	2611
6056 9086	PGR6A	4984	23	BPR6FS	2623	354	B6S	3510	2613	B9ES	2611
6056 9957	PFR6B	3500	24	BPR6FS	2623	355	B6S	3510	2614	B8ES	2411
6057 9903	PFR6B	3500	25	BPR5FS	2423	356	B4	3210	2615	B7ES	1111
6059 9495	PMR7A	4259	26	BPR4FS-15	2727	357	B4	3210	2616	B6ES	7310
7173 6281	CR7EB	4663	27	BPR4FS-15	2727	358	B2	3110	2634	B9HS-10	3626
7173 6282	BKR6EKC	2848	34	AP6FS	2710	363	BR6S	3522	2635	B8HS	5510
			43	APR6FS	2922	372	AB8	7909	2636	B7HS	5110
			44	APR6FS	2922	373	AB7	3010	2652	B9HS-10	3626
ALLIS CHALMERS	NGK → STOCK No.		45	APR5FS	3122	374	AB7	3010	2653	B7HS	5110
232560	AB-6	2910	46	APR5FS	3122	375	AB6	2910	2654	B7HS	5110
45NS	BPR4ES	7222	52	BP7ES	2412	376	AB6	2910	2655	B6HS	4510
4513315	AB-6	2910	53	BP6ES	7811	377	AB6	2910	2656	B5HS	4210
4516333	BPR4ES	7222	54	BP6ES	7811	378	AB6	2910	2675	B6L	3212
4516353	BPR4ES	7222	55	BP5ES	6511	379	AB2	3020	2676	B6L	3212
4613261	AB-6	2910	56	BP5ES	6511	386	AB6	2910	2695	AB8	7909
4660976	AB-6	2910	62	BP7ES	2412	393	B7ES	1111	2696	AB7	3010
4810105	AB-6	2910	63	BPR6ES	7822	394	B6ES	7310	2697	AB6	2910
4905798	B6ES	7310	64	BPR6ES	7822	395	B5ES	6410	2715	D8HA	7112
4905800	AB-6	2910	65	BPR6ES	7422	396	B5ES	6410	2716	D6HA	6512
4907334	BMR6A	7421	66	BPR5ES	7422	397	B5ES	6410	2735	D6HA	6512
4908597	AB-6	2910	67	BPR4ES	7222	398	B4ES	4129	2755	D8EA	2120
4910105	AB-6	2910	75	BP5S	3011	402	BR8ES	5422	2772	AB8	7909
4916015	AB-6	2910	76	BP5S	3011	403	BR6ES	4922	2775	AB6	2910
4920323	BP5EY	7327	77	BP4	2911	404	BR6ES	4922	2794	C8HSA	6821
4933394	BPR4ES	7222	85	BP4	2911	405	BR5ES	4722	2795	C7HSA	4629
4948894	BMR6A	7421	86	BP4	2911	406	BR5ES	4722	2796	C6HSA	3228
8762050	BP2ES	3467	87	BP4	2911	411	B9HS	5810	2852	BUH	2422
9001652	BMR6A	7421	94	BP7EFS	3526	413	B7HS	5110	2872	BUHW	2622
DCR42CLTS	BPR6EFS	3623	102	BP7EFS	3526	414	B6HS	4510	2892	BUHX	2522
DLM46	B4LM	3410	103	BPR6EFS	3623	415	B5HS	4210	2932	BUE	2322
DLM49	B4LM	3410	104	BPR6EFS	3623	416	B5HS	4210	2954	BM7F	6421
DR42CLTS	BPR6EFS	3623	105	BPR5EFS	2223	417	B4H	4110	2956	BM6F	6221
DR42LTS	BPR6EFS	3623	106	BPR5EFS	2223	424	B6HS	4510	2974	BPM7A	7321
			135	B7FS	3027	425	BR5HS	3722	2976	BPMR7A	4626
ALM	NGK → STOCK No.		143	BR6FS	4323	426	BR5HS	3722	3013	B7S	3710
8	BM6A	5921	144	BR6FS	4323	436	B6L	3212	3014	B6S	3510
19	B2LM	1147	145	BR6FS	4323	437	B4L	3112	3035	AB6	2910
ALM 8	BM6A	5921	146	BR5FS	4123	456	B4LM	3410	3036	BPR4FS-15	2727
ALM 19	B2LM	1147	147	BR5FS	4123	458	B2LM	1147	3074	G2Z	3320
			166	APR5FS	3122	483	BR7EFS	1094	3075	G2Z	3320
APRILIA	NGK → STOCK No.		175	BP5S	3011	494	B6L	3212	3116	AB6	2910
0297542	DR8EA	7162	203	BPR6FS	2623	497	B4L	3112	3203	BPR6ES	7822
0297830	BR10EG	3830	215	B6L	3212						
0297921	CR8E	1275	216	B6L	3212						
0297942	DCPR9E	2641	217	B4L	3112						
0297945	R0045J-10	7400									

AUTOLITE	NGK → STOCK No.	AUTOLITE	NGK → STOCK No.	BERU	NGK → STOCK No.	BERU	NGK → STOCK No.
3204	BPR6ES 7822	4153	DPR8EA-9 4929	14-5DP1	BP7ES 2412	14FR-5DTU	BCPR7ET 2164
3205	BPR5ES 7422	4162	DPR9EA-9 5329	14-5DTU	BP6ET 1263	14FR-5DU	BCPR7ES 3330
3206	BPR5ES 7422	4163	DR8ES-L 2923	14-5DU	BP7ES 2412	14FR-6DU	BKR6E 6962
3207	BPR5ES 7422	4164	D7EA 7912	14-5DUO	BP7ES 2412	14FR-6DUX	BCPR6ES-11 7121
3225	BP5S 3011	4173	D8HA 7112	14-5E	B7S 3710	14FR-6LDU3	BKR6EKE 5649
3226	BP5S 3011	4193	C7HSA 4629	14-6B	BP6HS 4511	14FR-7DU	BKR6E 6962
3227	BP5S 3011	4203	CR7HS 7223	14-6BU	BP6HS 4511	14FR-7DU2	BKR6EZ 4619
3243	BPR6EFS 3623	4251	BP8ES 2912	14-6C	B6ES 7310	14FR-7DUX	BKR6E-11 2756
3244	BPR6EFS 3623	4252	BP7ES 2412	14-6D	BP6ES 7811	14FR-7KPU	BKR6EP-8 2215
3245	BPR5EFS 2223	4253	BP6ES 7811	14-6D1	BP6ES 7811	14FR-7KPUV	BCPR6EP-11 3350
3246	BPR5EFS 2223	4263	BPR6ES 7822	14-6DPO	BP6ES 7811	14FR-7KPUX	BCPR6EP-11 3350
3264	B7FS 3027	4265	BPR5ES 7422	14-6DTU	BP6ET 1263	14FR-7KU	BKR6EY 3696
3265	BR6FS 4323	4275	BP5S 3011	14-6DU	BP6ES 7811	14FR-7KUO	BKR6EYA 2249
3266	BR5FS 4123	9062	BP6ET 1263	14-6DUO	BP6ESZ 7639	14FR-7KUOX	BKR6EYA-11 4073
3267	BR5FS 4123	9063	BP6ET 1263	14-7A	B6HS 4510	14FR-7LUX	BKR6EKC 2848
3286	APR6FS 2922	9064	BP5ET 2287	14-7AU	B6HS 4510	14FR-7LUX	ZFR6F-11 4291
3303	BPR6FS 2623	9921	BCPR6ET 2197	14-7B	BP6HS 4511	14FR-8DU	BKR5E 7938
3325	B6L 3212	AE6	B5HS 4210	14-7BU	BP6HS 4511	14FR-8DUX	BCPR5ES-11 3524
3327	B4L 3112			14-7C	B6ES 7310	14FR-8HU	BCRE527Y 2074
3345	BMR7A 4226			14-7CU	B6ES 7310	14FR-8KU	BKR5EY 7390
3364	BPR6HS 7022			14-7D	BP6ES 7811	14FR-8KUO	BKR5EYA 2087
3382	BR6S 3522			14-7DTU	BP6ET 1263	14FR-8KUOU	BKR5EYA-11 2526
3383	BR6S 3522			14-7DU	BP6ES 7811	14G-8DTU	BP6ET 1263
3384	BR6S 3522			14-7DUO	BP6ESZ 7639	14GH-7DTUR	BUR6ET 3172
3386	BR6S 3522			14-7E	B6S 3510	14GH-8DTUR	BUR5ET 3377
3388	BR6S 3522			14-8A	B5HS 4210	14GH-8DTURX	BUR5ET-10 7264
3423	B8S 3810			14-8AU	B5HS 4210	14GR-8DTU	BPR5EKE 5685
3426	BR6S 3522			14-8B	BP5HS 4111	14K-5DU	BP7EFS 3526
3462	BR7ES 5122			14-8BU	BP5HS 4111	14K-5DUO	BP7EFS 3526
3463	BR6ES 4922			14-8C	B5ES 6410	14K-6D	BP6EFS 3812
3464	BR6ES 4922			14-8C1	B6ES 7310	14K-6DU	BP6EFS 3812
3465	BR5ES 4722			14-8D	BP5ES 6511	14K-6DUO	BP6EFS 3812
3466	BR5ES 4722			14-8DTU	BP5ET 2287	14K-7D	BP6EFS 3812
3485	BR5HS 3722			14-8DTU EA1,0	BP5ET-10 5156	14K-7DU	BP6EFS 3812
3486	BR5HS 3722			14-8DU	BP5ES 6511	14K-7DUO	BP6EFS 3812
3507	B6L 3212			14-8DUO	BP5ES 6511	14K-8DU	BP5EFS 3712
3565	BPR5EFS 2223			14-8E	B4 3210	14K-8DUO	BP5EFS 3712
3604	BPR5FS-15 3124			14-8F	BP5S 3011	14K-9DU	BP5EFS 3712
3605	BPR4FS-15 2727			14-8LUR	ZGR5A 5839	14K-9DUO	BP5EFS 3712
3606	BPR4FS-15 2727			14-9C	B5ES 6410	14KGR-6KQU	BUR6EFSZ 6837
3607	BPR4FS-15 2727			14-9D	BP5ES 6511	14KR-6BU	BPR6FS 2623
3624	BR6FS 4323			14-9DTU	BP5ET 2287	14KR-6DU	BPR6EFS 3623
3666	B4LM 3410			14-9DU	BP5ES 6511	14KR-6ZPPV	PTR5A-10 5055
3684	BR7HS 4122			14-9DUO	BP5ES 6511	14KR-7DUX	BPR6EFS 3623
3686	BR6HS 3922			14-9EUO	B4LM 3410	14KR-8MPX	TR5A-10 0005
3702	BR9ES 5722			14F-03DAR	BKR6EK 2288	14KR-8MUV	PTR5A-10 5055
3703	BR9ES 5722			14F-5DPUR02	PFR7S8EG 1675	14R-11F	BP4 2911
3704	BR8ES 5422			14F-5DPURS2	PFR7S8EG 1675	14R-5DU	BPR7ES 2023
3705	BR6ES 4922			14F-5DU	BCP7ES 5030	14R-6B	BPR6HS 7022
3706	BR6ES 4922			14F-6DSR	BKR6E 6962	14R-6BU	BPR6HS 7022
3724	BPR5EFS 2223			14F-6DTU	BCP6ET 4563	14R-6D	BPR6ES 7822
3885	ZGR5C 6334			14F-6DUO	BCP6ES 4930	14R-6DU	BPR6ES 7822
3896	ZGR5C 6334			14F-6DUOR	BKR6E 6962	14R-7B	BPR6HS 7022
3922	BCPR7ES 3330			14F-6DPUR021	PFR7B 4853	14R-7BU	BPR6HS 7022
3924	BKR6E 6962			14F-7DPURX2	IFR6D10 5344	14R-7CU	BR6ES 4922
3926	BKR5E 7938			14F-7DU	BCP6ES 4930	14R-7D	BPR6ES 7822
3954	D8EA 2120			14F-7DUO	BCP6ES 4930	14R-7DU	BPR6ES 7822
3964	DR8ES-L 2923			14F-7DUOR	BKR6E 6962	14R-7DUX	BPR6EY-11 4228
3985	BPR5FS-15 3124			14F-7HUR2	ZFR5P-G 6893	14R-8DU	BPR5EY 2828
4043	BPR6ES-11 4824			14F-7LDUR	BKR6EK 2288	14R-8DUX	BPR5ES-11 4424
4052	B9ES 2611			14F-7LDUR4	BKR6EK 2288	14R-9DU	BPR5ES 7422
4053	B9ES 2611			14F-8DU	BCP5ES 7496	14R-9EUO	BR6S 3522
4054	B8ES 2411			14F-8DUO	BCP5ES 7496	14S-5F	BPM7A 7321
4055	B7ES 1111			14F-8LDUSR	BKR6EK 2288	14S-7E	BM6A 5921
4056	B6ES 7310			14F-8LUR	ZFR5F 5165	14S-7F	BPM6A 7021
4062	BR9ES 5722			14F-9DUO	BCP5ES 7496	14S-8F	BPM6A 7021
4063	BR9ES 5722			14FGH-6DTUR	BKUR7ET 7873	14SR-6F	BPMR6A 6726
4092	B7HS 5110			14FGH-7DTURX	BKUR6ET-10 2397	14-XAU	B6HS 4510
4093	B7HS 5110			14FGH-8DPURX2	PFR5G-11 2647	14Z-2C1	BR9EIX 3981
4113	BP6HS 4511			14FGH-8DTURX0	BKUR5ET 2789	14Z-3A1	B9HS 5810
4114	BP6HS 4511			14FGR-6DDU	BKR6EKUB 3584	14Z-3AU	B8HS 5510
4123	BPR6HS 7022			14FGR-7CTU	BCPR7ET 2164	14Z-3C1	B9ES 2611
4132	D8EA 2120			14FGR-8DQU7	BKR5EQUB 1567	14Z-3CU	B8ES 2411
4143	DR8ES-L 2923			14FLR-8LDUX	BKR5EK 7956	14Z-4AU	B8HS 5510

BERU	NGK → STOCK No.	BERU	NGK → STOCK No.	BERU	NGK → STOCK No.	BERU	NGK → STOCK No.
14Z-6A2	B6HS 4510	Z 2	BP5ET 2287	Z 82	BPR5ES 7422	12 12 7 699 116	KR9CI 7795
14Z-7AU	B7HS 5110	Z 3	ZGR5A 5839	Z 83	B4LM 3410	12 12 7 728 635	KR9CI 7795
160/14/3	B6ES 7310	Z 4	ZFR5F 5165	Z 84	BR4LM 4133	12 12 8 396 345	LMAR9FI-10G 92850
175/14	B6HS 4510	Z 5	BCP5ES 7496	Z 85	B6HS 4510	12 12 8 560 811	LMAR8AI-10 94319
175/14/3	B6ES 7310	Z 6	BP5EFS 3712	Z 86	AB7 3010	12 12 8 569 360	LMAR8J-9E 93972
175/14/3A	BP6ES 7811	Z 7	BP5EFS 3712	Z 87	AB7 3010	12 12 9 061 870	ZFR5F 5165
175/14/5	B6S 3510	Z 8	BPR5ES 7422	Z 88	AB6 2910	12 12 9 063 428	BKR6EK 2288
175/14/5AMX	BPM6A 7021	Z 9	BPR5ES-11 4424	Z 89	BKUR6ET 6437	12 12 9 064 617	BKR6EK 2288
175/14A	BP6HS 4511	Z 10	BP6HS 4511	Z 90	BKUR6ET-10 2397	12 12 9 064 619	BKR6EK 2288
175/18	AB6 2910	Z 11	BP6ES 7811	Z 91	BUR6ET 3172	12 12 9 064 656	BKR6EK 2288
175/18K	AP6FS 2710	Z 12	BP6ET 1263	Z 92	BUR5ET 3377	12 12 9 065 366	BKR6EK 2288
18-10A	AB6 2910	Z 13	BKR6E 6962	Z 93	BUR5ET-10 7264	12 12 9 069 048	PKR7A 3641
18-10AU	AB6 2910	Z 14	BKR6EK 2288	Z 94	BPR5EKU 5685	12 12 9 071 003	BKR6EQUP 3199
18-12B	AB2 3020	Z 15	BKR6E 6962	Z 95	BPR6EFS 3623	13 12 0 032 134	IZFR6H11 4294
18-4A1	AB7 3010	Z 16	BCPR6ES-11 7121	Z 97	PTR5A-10 5055	75 50 01102	ZKBR7A-HTU 91785
18-4A2	AB7 3010	Z 17	BCP6EFS 3812	Z 99	BCPR6ES-11 7121	7 650 676	BKR6EKC 2848
18-5A	AB7 3010	Z 18	BP6EFS 3812	Z 100	BKR6ES 3783	7 653 771	BKR6EKC 2848
18-5AS	AB7 3010	Z 19	BPR6HS 7022	Z 101	BKR6EK 2288	8 560 811	LMAR8AI-10 94319
18-5AU	AB7 3010	Z 20	BPR6ES 7822	Z 103	BP7ES 2412		
18-7A	AB6 2910	Z 21	BPR6ES-11 4824	Z 104	BP6ES 7811		
18-7AU	AB7 3010	Z 22	BP6ES 7811	Z 105	BKR6E 6962	BOMBARDIER	NGK → STOCK No.
18-8A	AB6 2910	Z 23	BKR6E 6962	Z 107	BP4 2911	219 800 231	KR8BI 4347
18K-6BU	AP6FS 2710	Z 24	BKR6E 6962	Z 112	B4 3210	415129670	MR7BI-8 90982
18K-7B	AP6FS 2710	Z 25	BP6EFS 3812	Z 144	BUR6EFSZ 6837		
18K-7BU	AP6FS 2710	Z 26	BPR6EFS 3623	Z 145	BKR6EKUB 3584		
190/14Z	B6HS 4510	Z 27	BPR6ES 7822	Z 149	BCPR6EP-11 3350	BONON - See CHINESE BRANDS	
200/14/3	B6ES 7310	Z 28	BPR6ES-11 4824	Z 150	BCPR6EP-11 3350	BOSCH	NGK → STOCK No.
200/14/3A	BP6ES 7811	Z 29	BCP7ES 5030	Z 151	BKR6EP-8 2215	+1	BPR6ES 7822
200/14/3K	BP6EFS 3812	Z 30	BCPR7ES 3330	Z 152	BCRE527Y 2074	+2	BUR6ET 3172
200/14A	BP6HS 4511	Z 31	BP7EFS 3526	Z 153	BKR5EY 7390	+3	BPR5ES 7422
215/14/3A	BP6ES 7811	Z 32	AP6FS 2710	Z 154	BKR5EYA 2087	+4	BUR5ET 3377
225/14	B7HS 5110	Z 33	AP6FS 2710	Z 155	BKR6EY 3696	+5	BPR6EFS 3623
225/14/3	B7ES 1111	Z 35	D7EA 7912	Z 156	BKR6EYA 2249	+6	BKR5E 7938
225/14/3A	BP7ES 2412	Z 36	D7EA 7912	Z 157	BKR6EYA-11 4073	+7	BKR6EKC 2848
225/14/3S	B7ECS 2528	Z 37	B9HS 5810	Z 158	ZFR6F-11 4291	+8	BKR6E 6962
225/14/5	B7S 3710	Z 38	B9ES 2611	Z 203	ZFR6F-11 4292	+9	BKR5EK 7956
225/14/5AMX	BPM7A 7321	Z 39	B8HS 5510	Z 315	PLTR6A-10G 3587	+10	BPR6HS 7022
225/14A	BP7HS 5111	Z 40	B7HS 5110			+11	BCPR6ES-11 7121
225/18	AB7 3010	Z 41	BP7HS 5111	BETAMOTOR	NGK → STOCK No.	+12	BPR6ES 7822
225/18S	AB7 3010	Z 42	BP7ES 2412	036.11.001.00.00	GR7CI-8 95476	+13	BKR6E 6962
230/14/3A	BP7ES 2412	Z 43	BP7ES 2412	361100100	GR7CI-8 95476	+14	BPR5EFS 2223
235/14/3P	BP7ES 2412	Z 44	BP6ET 1263			+15	BPR7ES 2023
240/14	B7HS 5110	Z 45	BCPR7ET 2164	BMW	NGK → STOCK No.	+16	BPR5ES 7422
240/14/3	B7ES 1111	Z 46	BP7EFS 3526	11 127 675 485	KR9CI 7795	+17	PTR5A-10 5055
240/14A	BP7HS 5111	Z 47	BP7ES 2023	12 12 0 022 902	DCPR8EK 7415	+18	BPR6EFS 3623
240/14S	BR8HIX 7001	Z 48	BP6HS 4511	12 12 0 030 548	BKR6EQUP 3199	+19	BKR5E-11 6953
240/18	AB7 3010	Z 49	BPR6FS 2623	12 12 0 031 708	BKR7EQUP 4285	+20	BPR5HS 6222
260/14	B8HS 5510	Z 50	BP6ESZ 7639	12 12 0 032 134	IZFR6H11 4294	+21	BPR6ES-11 4824
260/14/3	B8ES 2411	Z 51	BP6ET 1263	12 12 0 032 135	IZFR6H11 4294	+22	BPR5ES-11 4424
260/14S	BR8HIX 7001	Z 52	BCP6ET 4563	12 12 0 032 136	BKR6EQU 6002	+23	BKR6EKUB 3584
260/18	AB8 7909	Z 53	BCP6ET 4563	12 12 0 032 137	ILZFR6D11 1208	+24	PFR6B 3500
265/14/3P	BR8EIX 5044	Z 54	BCP6ES 4930	12 12 0 032 138	PLZFR6A-11S 5987	+25	BPR4FS 1127
280/14	B8HS 5510	Z 55	BP6EFS 3812	12 12 0 032 273	LKR8AP 4471	+27	BPR6ES-11 4824
280/14/3S	BR8EIX 5044	Z 56	BP6EFS 3812	12 12 0 034 091	ZKBR7A-HTU 91785	+31	BCPR6EY-11 3720
280/14/3Z	B9ES 2611	Z 57	B6HS 4510	12 12 0 034 098	PLZKBR7B8DG 90223	+32	ZFR6F-11 4291
280/14Z	B9HS 5810	Z 58	B6ES 7310	12 12 0 035 531	ILZKBR7B8G 97968	+33	BPR4FS-15 2727
310/14/3Z	BR9EIX 3981	Z 59	BR6ES 4922	12 12 0 035 915	PLZFR6A-11S 5987	+34	ZGR5A 5839
95/14	B4H 4110	Z 60	BCPR7ET 2164	12 12 0 037 607	BKR6EQUP 3199	+36	BKR5EKB-11 3967
95/14/3	B4ES 4129	Z 61	BP6ESZ 7639	12 12 0 037 663	LZFR6AP11GS 95712	+39	TR5B-13 4559
95/14/5	B4 3210	Z 62	BP6ESZ 7639	12 12 0 038 349	ZKBR7A-HTU 91785	+40	LZKAR7A 6799
95/14/5A	BP4 2911	Z 63	BCP6ES 4930	12 12 0 038 896	SILZKBR8D8S 97506	+41	DCPR7E-N-10 4983
95/14A	BP4HS 3611	Z 64	BCP6ES 4930	12 12 0 039 664	SILZKBR8D8S 97506	+42	LF6B 6677
95/18	AB6 2910	Z 66	BP6EFS 3812	12 12 0 040 551	SILZKGR8B8S 94201	+43	BKR5EYA-11 2526
D 215/14/3 (14/5/C)	B7ES 1111	Z 68	B5HS 4210	12 12 0 041 666	SILZKGR8B8S 94201	+44	BKUR5ET-10 7553
D175/14	B6HS 4510	Z 71	BCP5ES 7496	12 12 0 141 871	BKR6EQUP 3199	+45	PFR5G-11 2647
D175/14/3	B6ES 7310	Z 72	BCPR5ES 6130	12 12 1 435 955	BKR6EQUP 3199	+47	BKR5EYA 2087
D200/14/3A	BP6ES 7811	Z 73	BCPR5ES-11 3524	12 12 2 158 252	IZFR6H11 4294	+48	BKR6EQUP 3199
D215/14/3	BP6ES 7811	Z 74	BKR5EK 7956	12 12 2 163 332	PLZKBR7B8DG 90223	+49	PTR6F-13 7569
D230/14/3A	BP7ES 2412	Z 75	BUR5ET 3377	12 12 2 293 697	PLZKBR7B8DG 90223	+51	ZFR5P-G 6893
RS33	BPR5EIX 6597	Z 76	BP5ES 6511	12 12 2 343 144	D8EA 2120	+52	PZFR5D-11 7968
RS35	BPR6EIX 6637	Z 78	BP5ET 2287	12 12 7 653 439	CR8EB 7784	+53	BKR6EK 2288
RS37	BPR7EIX 4055	Z 79	BCP5ES 7496	12 12 7 653 771	BKR7EKC 7354	+57	ZFR5F 5165
RS39	BPR7EIX 4055	Z 80	BP5EFS 3712	12 12 7 681 415	DCPR8EK 7168	0 241 050 002	C7HSA 4629
Z 1	BP5ES 6511	Z 81	BP5EFS 3712	12 12 7 690 603	DCPR8E 4339	0 241 055 501	CR7HSA 4549
						0 241 056 501	C7E 5096

BOSCH	NGK → STOCK No.	BOSCH	NGK → STOCK No.	BOSCH	NGK → STOCK No.	BOSCH	NGK → STOCK No.
F6DCOR	BKR6E 6962	FR6DP1X	BKR6EP-11 2978	FR8DPX	BKR5E-11 6953	HR6DS	BPR6EFS 3623
F6DCX	BCPR6ES-11 7121	FR6DPP32	PFR6B 3500	FR8DS	BKR5EVX 2546	HR7D+	BPR6EFS 3623
F6DP	BCP6ES 4930	FR6DPX	BCPR6ES-11 7121	FR8DX	BKR5E-11 6953	HR7DC	BPR6EFS 3623
F6DPOR	PFR6Q 6458	FR6DTC	BCPR6ET 2197	FR8HDC	BKR5EKB-11 3967	HR7DC+	BPR6EFS 3623
F6DSR	BKR6EIX 6418	FR6DTCW	BCPR6ET 2197	FR8HDC+	BKR5EKB-11 3967	HR7KPP33	PTR6F-13 7569
F6DTC	BCP6ET 4563	FR6KDC	BKR6EK 2288	FR8HP	ZFR5F-11 2262	HR7KPP33+	PTR6F-13 7569
F6KPP332S	PFR7S8EG 1675	FR6KDC+	BKR6EK 2288	FR8KC	BKR5EYA-11 2526	HR7MEV	TR5B-13 4559
F6LTCR	BKUR7ET 7873	FR6KII332S	IFR7X7G 91039	FR8KC+	BKR5EYA-11 2526	HR7MEV0	TR5A-10 0005
F6MPP332	ILFR6A 3588	FR6KPP32S	PFR6Q 6458	FR8KCU	BKR5EYA-11 2526	HR7MPP	PTR5A-10 5055
F7DC	BCP6ES 4930	FR6KPP33	IFR6T11 4589	FR8KI33V	IFR5E13 6903	HR7MPP+	PTR5A-10 5055
F7DCO	BCP6ES 4930	FR6KPP33+	IFR6T11 4589	FR8KI33X	BPR6EFIX-10 94658	HR7MPP+V	PTR5A-10 5055
F7DCOR	BKR6E 6962	FR6LDC	BKR6EKC 2848	FR8KTC	BKUR5ET-10 7553	HR7MPP302X	PTR5A-10 5055
F7DCR4	BKR6E 6962	FR6LTC	BKUR7ET 7873	FR8KTC+	BKUR5ET-10 7553	HR8A	BR5FS 4123
F7DCX	BCPR6ES-11 7121	FR6MPP10	ILFR6B 6481	FR8KTCR	BKUR5ET 2789	HR8AC	BR5FS 4123
F7DP	BCP6ES 4930	FR6MPP332	ILFR6A 3588	FR8LCX	ZFR6F-11 4291	HR8AP	BR5FS 4123
F7DPER	IFR6D10 5344	FR7DII35V	IFR6D13 94167	FR8LDC	BKR5EK 7956	HR8B	BPR5FS 2423
F7DTC	BCP6ET 4563	FR7D+	BKR6ES 3783	FR8LDC4	BKR5EK 7956	HR8BC	BPR5FS 2423
F7HER02	ZFR6T-11G 5960	FR7D+X	BKR6E-11 2756	FR8LI332S	IZFR5B 4080	HR8BCY	BPR5FS-15 3124
F7HER2	ZFR5P-G 6893	FR7DC	BKR6E 6962	FR8ME	LF85B 7113	HR8BP	BPR5FS 2423
F7HPP22	PZFR5D-11 7968	FR7DC+	BKR6E 6962	FR8NEU	LF86C-11 5788	HR8BPX	BPR5FS-11 2924
F7HPPRX	PZFR5D-11 7968	FR7DCO	BKR6E 6962	FR8SC	LF86B 6677	HR8BPY	BPR5FS-15 3124
F7KPP332U	PFR6X-11 5757	FR7DCC	BKR6E 6962	FR8SC+	LF86B 6677	HR8BY	BPR5FS-15 3124
F7KTCR	BKUR6ET 6437	FR7DC9	BKR6E 6962	FR8SEO	LF86B 6677	HR8D+	BPR5EFS 2223
F7LCOR2	ZFR6F-11 4291	FR7DCX	BCPR6ES-11 7121	FR8SPP332	PLFR5A-11 6240	HR8DC+	BPR5EFS 2223
F7LCR	ZFR6A-11 1041	FR7DCC+	BCPR6ES-11 7121	FR9HC	ZFR4F-11 4043	HR8DPP22U	PTR5D-10 3784
F7LDCR	BKR6EK 2288	FR7DE	BKR6EZ 4619	FR9LCX	ZFR6V-G 8894	HR8MCV	TR5B-13 4559
F7LTCR	BKUR6ET-10 2397	FR7DP	BKR6E 6962	H10BC	BPR4FS 1127	HR8MCV+	TR5B-13 4559
F8DC	BCP5ES 7496	FR7DP1X	PFR6B-11 4014	H2CS	B9EFS 1085	HR8MEV	TR5B-13 4559
F8DCO	BCP5ES 7496	FR7DPP+	PFR6B 3500	H3CS	B8EFS 1049	HR8NPP302	PTR5A-10 5055
F8DCOR	BCPR5ES 6130	FR7DPP10	BKR6EIX 6418	H5D	BP7EFS 3526	HR9A	BR5FS 4123
F8DC4	BCP5ES 7496	FR7DPP22U	PFR6N-11 3546	H5DC	BP7EFS 3526	HR9AC	BR5FS 4123
F8DCX	BCPR5ES-11 3524	FR7DPP33	PFR6Q 6458	H5DCO	BP7EFS 3526	HR9AP	BR5FS 4123
F8DPER	PFR5G-11 2647	FR7DPX	BKR6E-11 2756	H5DP	BP7EFS 3526	HR9B	BPR4FS 1127
F8KTCR	BKUR5ET 2789	FR7DTC	BCPR6ET 2197	H6B	BP6FS 3512	HR9BC	BPR4FS 1127
F8LCR	ZFR5F 5165	FR7HC	ZFR5P-G 6893	H6BC	BP6FS 3512	HR9BC+	BPR4FS 1127
F8LCR2	ZFR5F 5165	FR7HC+	ZFR5P-G 6893	H6D	BP6EFS 3812	HR9BCY	BPR4FS-15 2727
F8LDCR	BKR6EK 2288	FR7HE02	ZFR6T-11G 5960	H6DC	BP6EFS 3812	HR9BCY+	BPR4FS-15 2727
F9LCR	ZFR4F-11 4043	FR7HPP33	PZFR5D-11 7968	H6DCO	BP6EFS 3812	HR9BP	BPR4FS 1127
FGR5KQEO	BKR7EQUP 4285	FR7HPP33+	PZFR5D-11 7968	H6DP	BP6EFS 3812	HR9BPX	BPR4FS-11 2527
FGR6HQEO	ZFR6S-Q 6449	FR7HPP332	PZFR5N-11T 7742	H7CC	BR6EF 3177	HR9BPY	BPR4FS-15 2727
FGR6KQC	BKR6EQUP 3199	FR7KC	BKR5EYA 2087	H7CP	BR6EF 3177	HR9BY	BPR4FS-15 2727
FGR7DOE	BKR6EKUB 3584	FR7KC+	BKR5EYA 2087	H7D	BP6EFS 3812	HR9D	BPR5EFS 2223
FGR7DQE+	BKR6EKUB 3584	FR7KCV	BKR5EYA 2087	H7DC	BP6EFS 3812	HR9DC	BPR5EFS 2223
FGR7DQEO	BKR6EKUB 3584	FR7KCX	BCPR6EY-11 3720	H7DCO	BP6EFS 3812	HR9DPX	BPR6EFIX-10 94658
FGR7DQP	BKR6EQUP 3199	FR7KCX+	BCPR6EY-11 3720	H7DP	BP6EFS 3812	HR9KII33Y	TR5A1-13 90813
FGR7DQP+	BKR6EQUP 3199	FR7KDC	BKR6EKC 2848	H8B	BP5FS 3412	HS5E	BM7F 6421
FGR7KQC	BKR6EQUP 3199	FR7KPP332	IZFR6H11 4294	H8BC	BP5FS 3412	HS8E	BM6F 6221
FGR7KQE	BKR6EQUP 3199	FR7KTC	BKUR6ET-10 2397	H8BP	BP5FS 3412	M10A	AB6 2910
FGR7KQEO	BKR6EQUP 3199	FR7LC2	BKR6E 6962	H8C	BP5EFS 3712	M10A0	AB6 2910
FGR8KQEO	BKR5EQUB 1567	FR7LCX	ZFR6F-11 4291	H8DCO	BP5EFS 3712	M10AC	AB6 2910
FLR7HTCO	BKUR6ET-10 2397	FR7LCX+	ZFR6F-11 4291	H8DP	BP5EFS 3712	M10ACO	AB6 2910
FLR8LDCU	BKR5EK 7956	FR7LD	BKR6EK 2288	H9BC	BPR4FS 1127	M12B	AB6 2910
FLR8LDCU+	BKR5EK 7956	FR7LD+	BKR6EK 2288	H9BCY	BPR4FS-15 2727	M145T1	AB6 2910
FLR8LDU+	BKR5EK 7956	FR7LDC	BKR6EKC 2848	H9DC	BP5EFS 3712	M145T5	AB6 2910
F03DAR	BKR6EK 2288	FR7LDC+	BKR6EKC 2848	H9DCO	BP5EFS 3712	M175T1	AB6 2910
F05NPP332S	PLFER7A8EG 94833	FR7ME	LF86B 6677	H9HP	BP5EFS 3712	M225T1	AB7 3010
FQR8DE	BKR6EZB 4293	FR7MPP10	ILFR6B 6481	HLR8STEX	LTR6B-10T 5948	M240T1	AB7 3010
FQR8LE2	ZFR5F 5165	FR7NI33	ILFR6B 6481	HR10A	BR5FS 4123	M280T1	AB8 7909
FQR8LEU2	ZFR5F 5165	FR7NPP33	ILZFR6C-K 6645	HR10AC	BR5FS 4123	M45T1	AB6 2910
FR5DC	BCPR7ES 3330	FR7SE	LF86C-11 5788	HR10B	BPR4FS 1127	M4A	AB7 3010
FR5DC+	BCPR7ES 3330	FR7SI30	ILZFR6C-K 6645	HR10BC	BPR4FS 1127	M4A1	AB8 7909
FR5DCX	BCPR7ES-11 1095	FR7SPP302U	ILZFR6AP11GS 95712	HR10BCX	BPR4FS-11 2527	M4A2	AB7 3010
FR5DP	BCPR7ES 3330	FR8D+	BKR5E 7938	HR10BCY	BPR4FS-15 2727	M4AC	AB7 3010
FR5DTC	BCPR7ET 2164	FR8D+X	BKR5E-11 6953	HR10BX	BPR4FS-11 2527	M5A	AB7 3010
FR5KPP332S	PFR7S8EG 1675	FR8DC	BKR5E 7938	HR10BY	BPR4FS-15 2727	M5AC	AB7 3010
FR5LDC	BKR7EKC 7354	FR8DC+	BKR5E 7938	HR6B	BPR6FS 2623	M7A	AB6 2910
FR6D+	BKR6ES 3783	FR8DCO	BKR5E 7938	HR6BC	BPR6FS 2623	M7AC	AB7 3010
FR6DC	BKR6E 6962	FR8DCU	BKR5E-11 6953	HR6BP	BPR6FS 2623	M8A	AB6 2910
FR6DC+	BKR6E 6962	FR8DCX	BKR5E-11 6953	HR6D	BPR6EFS 3623	M8A0	AB6 2910
FR6DC2	BKR6E 6962	FR8DCX+	BKR5E-11 6953	HR6D+	BPR6EFS 3623	M8AC	AB6 2910
FR6DCX	BCPR6ES-11 7121	FR8DE	BKR5EZ 7642	HR6DC	BPR6EFS 3623	M95T1	AB6 2910
FR6DDC	BKR7EKC-N 2095	FR8DII33X	IFR5N10 7866	HR6DC+	BPR6EFS 3623	M95T5	AB6 2910
FR6DE	BKR6E 6962	FR8DPP33	PFR5G-11 2647	HR6DP	BPR6EFS 3623	MA145TR7	APR5FS 3122
FR6DP	BKR6EP-8 2215	FR8DPP33+	PFR5G-11 2647	HR6DPP33V	ITR6F13 4477	MA175T7	AP6FS 2710

BOSCH	NGK → STOCK No.	BOSCH	NGK → STOCK No.	BOSCH	NGK → STOCK No.	BOSCH	NGK → STOCK No.
MA200T7	AP6FS 2710	W175Z1	B6HS 4510	W4DPO	BPR7EIX 4055	W8DCO	BP5ES 6511
U3AC	C7HSA 4629	W2A	B9HS 5810	W4E2	B7S 3710	W8DP	BP5ES 6511
U3CC	C7E 5096	W2AC	B9HS 5810	W5A	B7HS 5110	W8DTC	BP5ET 2287
U4AC	C7HSA 4629	W2AP	BR9HIX 5687	W5AC	B7HS 5110	W8E	B6S 3510
UR07CDC	CR9EK 4548	W2AS	BR9HIX 5687	W5AP	B7HS 5110	W8EC	B6S 3510
UR08CC	CR9E 6263	W2CS	BR10EIX 6801	W5AS	BR7HIX 7067	W8F	BP5S 3011
UHR08CC	CR9EH-9 7502	W2D	BP9ES 7526	W5B	BP7HS 5111	W8FC	BP5S 3011
UHR09CI30	IMR9C-9H 6777	W200T30	BP6ES 7811	W5BC	BP7HS 5111	W8LCR	ZGR5A 5839
UR06CDC	CR10EK 2360	W200T35	BP6HS 4511	W5BP	BP7HS 5111	W8LDCR	BUR6ET 3172
UR2AS	CR8HS 7423	W200TR30	BPR6ES 7822	W5C	B7S 1111	W8LPR	ZGR5A 5839
UR2CC	CR8E 1275	W215T30	BP6ES 7811	W5CC	B7ES 1111	W8LTCR	BUR5ET 3377
UR2CDC	CR8EK 3478	W225T1	B7HS 5110	W5CP	B7ES 1111	W95T1	B4H 4110
UR3AC	CR7HSA 4549	W225T2	B7ES 1111	W5CS	BR7EIX 6664	W95T2	B4ES 4129
UR3AS	CR7HS 7223	W225T3	B7S 3710	W5D	BP7ES 2412	W95T3	B4 3210
UR4AS	CR6HS 7023	W225T35	BP7HS 5111	W5D1	BP7ES 2412	W95T6	BP4 2911
UR5	CR7HSA 4549	W225TR30	BPR7ES 2023	W5DC	BP7ES 2412	W9A	B4H 4110
UR6DC	CPR7EA-9 3901	W230T30	BP7ES 2412	W5DCO	BP7ES 2412	W9A0	B4H 4110
USR4AC	CMR6H 3365	W240M1	B8HS 5510	W5DP	BP7ES 2412	W9AC	B5HS 4210
USR7AC	CMR6H 3365	W240MZ1	B8HS 5510	W5DPO	BPR7EIX 4055	W9ACO	B5HS 4210
V6SII332S	SILZKFR8D7S 95875	W240T1	B8HS 5510	W5DTC	BP6ET 1263	W9C	B4ES 4129
V6SII3328	SILZKFR8E7S 90654	W240T2	B8ES 2411	W5E	B7S 3710	W9CC	B4ES 4129
VR5NC	LKAR8A-9 4786	W240T3	B7S 3710	W5EC	B7S 3710	W9D	BP5ES 6511
VR5NE	LKAR8A-9 4786	W250P21	BP7ES 2412	W5EP	B7S 3710	W9DC	BP5ES 6511
VR6NE	LZKAR7B 5942	W250T1	B8HS 5510	W6B	BP6HS 4511	W9DP	BP5ES 6511
VR7NII33X	ILKAR7B11 4912	W250T2	B8ES 2411	W6BC	BP6HS 4511	W9DTC	BP5ET 2287
VR7SPP33	PLZKAR6A-11 5118	W255T30	BP7ES 2412	W6BP	BP6HS 4511	W9E	B4 3210
VR7TII35U	DILKAR7E11HS 97439	W260M1	B8HS 5510	W6D	BP6ES 7811	W9EO	B4LM 3410
VR8NII35U	DILKAR6A11 9029	W260MZ1	B8HS 5510	W6D1	BP6ES 7811	W9EC	B4 3210
VR8SC	LZKAR7A 6799	W260M2	B9ES 2611	W6DC	BP6ES 7811	W9ECO	B4LM 3410
VR8SC+	LZKAR7A 6799	W260S1S	BR8HIX 7001	W6DC	BP6ES 7811	W9F	BP5S 3011
VR8SE	LZKAR7A 6799	W260T1	B8HS 5510	W6DCO	BP6ES 7811	W9FC	BP5S 3011
VR8SEW	LZKAR7A 6799	W260T2	B9ES 2611	W6DCO	BP6ESZ 7639	W9LC	ZGR5A 5839
VR8SII33X	ILKAR7B11 4912	W260T20	B8ES 2411	W6DP	BPR6EIX 6637	WA125TR30	BPR5EFS 2223
W06AS	BR10HIX 6692	W275T1	B8HS 5510	W6DPO	BPR6EIX 6637	WA200T30	BP6EFS 3812
W06CS	B11EGV 5831	W275T2	B9ES 2611	W6DPX	BPR6EIX-11 3903	WA200TR30	BPR6EFS 3623
W07AS	BR10HIX 6692	W280MZ1	B8HS 5510	W6DTC	BP6ET 1263	WA225T30	BP7EFS 3526
W07CS	BR10EIX 6801	W280MZ2	B9ES 2611	W7A	B6HS 4510	WAK145T3	BM6F 6221
W08AS	BR9HIX 5687	W280S1S	BR9HIX 5687	W7A0	B6HS 4510	WAK225T3	BM7F 6421
W08CS	BR10EIX 6801	W280S2S	BR9EIX 3981	W7AC	B6HS 4510	WEA	BUH 2422
W10A	B4H 4110	W280T30	BP8ES 2912	W7AP	B6HS 4510	WEC	BUE 2322
W10AC	B4H 4110	W3A	B8HS 5510	W7B	BP6HS 4511	WET1	BUH 2422
W10C	B4ES 4129	W3A0	B8HS 5510	W7BC	BP6HS 4511	WET2	BUE 2322
W10CC	B4ES 4129	W3AC	B8HS 5510	W7BP	BP6HS 4511	WKA145T3	BM6A 5921
W10DC	BPR4ES 7222	W3AP	B8HS 5510	W7C	B6ES 7310	WKA145T6	BPM6A 7021
W10E	B4 3210	W3AS	BR8HIX 7001	W7CC	B6ES 7310	WKA175T3	BM6A 5921
W10F	BP4 2911	W3C	B9ES 2611	W7CCO	B6ES 7310	WKA175T6	BPM6A 7021
W10FC	BP4 2911	W3CO	B9ES 2611	W7CP	B6ES 7310	WKA200TR6	BPMR6A 6726
W11E0	B4LM 3410	W3CC	B9ES 2611	W7D	BP6ES 7811	WKA225T3	BM7A 6521
W125T1	B4H 4110	W3CP	B9ES 2611	W7D0	BP6ES 7811	WKA225T6	BPM7A 7321
W125T2	B4ES 4129	W3CS	BR9EIX 3981	W7D0	BP6ES 7811	W06CS	B11EGV 5831
W125T3	B4 3210	W3D	BP8ES 2912	W7DC	BP6ES 7811	WR08AC	BR9HS 4522
W125T30	BP5ES 6511	W3DP	BPR8EIX 6684	W7DCO	BP6ESZ 7639	WR09CC	BR10ES 4832
W125T4	B4H 4110	W3DPO	BPR8EIX 6684	W7DCR	BPR6ES 7822	WR10A	BR4HS 3322
W125TR2	BR5ES 4722	W3DP2	BP8ES 2912	W7DCX	BPR6ES-11 4824	WR10AC	BR4HS 3322
W125TR3	BR6S 3522	W300T1	B9HS 5810	W7DP	BP6ES 7811	WR10DC	BPR4ES 7222
W125TR30	BPR5ES 7422	W300T30	BP9ES 7526	W7DTC	BP6ET 1263	WR10E	BR6S 3522
W12A	B4H 4110	W310S1S	BR9HIX 5687	W7E	B6S 3510	WR10F	BP4 2911
W12E	B2 3110	W310S2S	BR10EIX 6801	W7EC	B6S 3510	WR10FC	BP4 2911
W145T1	B5HS 4210	W45T1	B4H 4110	W7EP	B6S 3510	WR11E0	BR4LM 4133
W145T1.1	B5HS 4210	W4A	B8HS 5510	W7LTCR	BUR6ET 3172	WR240T1	BR8HS 4322
W145T2	B5ES 6410	W4A1	B8HS 5510	W8A	B5HS 4210	WR3CC	BR9ES 5722
W145T3	B6S 3510	W4A2	B8HS 5510	W8A0	B5HS 4210	WR3CTC	BR9ET 4528
W145T30	BP5ES 6511	W4A5	B8HS 5510	W8AC	B5HS 4210	WR4AC	BR8HS 4322
W145T35	BP5HS 4111	W4AC	B8HS 5510	W8AP	B5HS 4210	WR4CC	BR8ES 5422
W145TR2	BR5ES 4722	W4AP	B8HS 5510	W8B	BP5HS 4111	WR4CP	BR8EIX 5044
W145TR3	BR6S 3522	W4AS	BR8HIX 7001	W8BC	BP5HS 4111	WR5A	BR7HS 4122
W145TR30	BPR5ES 7422	W4C	B8ES 2411	W8BP	BP5HS 4111	WR5AC	BR7HS 4122
W175T1	B6HS 4510	W4C1	B8ES 2411	W8C	B5ES 6410	WR5BC	BPR7HS 6422
W175T2	B6ES 7310	W4C2	B7ES 1111	W8CO	B5ES 6410	WR5CC	BR7ES 5122
W175T3	B6S 3510	W4C3	B7HS 5110	W8CC	B5ES 6410	WR5CP	BR7ES 5122
W175T30	BP6ES 7811	W4CC	B8ES 2411	W8CCX	B5ES 6410	WR5D	BPR7ES 2023
W175T35	BP6HS 4511	W4CP	BR8EIX 5044	W8CP	B5ES 6410	WR5D+	BPR7ES 2023
W175TR1	BR6HS 3922	W4CS	BR8EIX 5044	W8D	BP5ES 6511	WR5DC	BPR7ES 2023
W175TR30	BPR6ES 7822	W4DP	BPR7EIX 4055	W8DC	BP5ES 6511	WR5DC+	BPR7ES 2023

BOSCH	NGK → STOCK No.	
WR5DP	BPR7ES	2023
WR5DS	BPR7EIX	4055
WR6BC	BPR6HS	7022
WR6D	BPR6ES	7822
WR6D+	BPR6ES	7822
WR6DC	BPR6ES	7822
WR6DC+	BPR6ES	7822
WR6DCX	BPR6ES-11	4824
WR6DP	BPR6ES	7822
WR6DPO	BPR6ES	7822
WR6DPX	BPR6ES-11	4824
WR6DS	BPR6EIX	6637
WR6DTC	BP6ET	1263
WR7A	BR6HS	3922
WR7AC	BR6HS	3922
WR7B	BPR6HS	7022
WR7B+	BPR6HS	7022
WR7BC	BPR6HS	7022
WR7BC+	BPR6HS	7022
WR7BP	BPR6HS	7022
WR7C	BR6ES	4922
WR7CC	BR6ES	4922
WR7CP	BR6ES	4922
WR7D	BPR6ES	7822
WR7D+	BPR6ES	7822
WR7DC	BPR6ES	7822
WR7DC+	BPR6ES	7822
WR7DCX	BPR6ES-11	4824
WR7DCX+	BPR6ES-11	4824
WR7DP	BPR6EIX	6637
WR7DS	BPR6EIX	6637
WR7KI33S	IGR6A11	5743
WR7LTC	BUR6ET	3172
WR7LTC+	BUR6ET	3172
WR8AC	BR5HS	3722
WR8AC+	BR5HS	3722
WR8B+	BPR5HS	6222
WR8BC+	BPR5HS	6222
WR8C	BR5ES	4722
WR8CC	BR5ES	4722
WR8CP	BR5ES	4722
WR8D	BPR5ES	7422
WR8D+	BPR5ES	7422
WR8DC	BPR5ES	7422
WR8DC+	BPR5ES	7422
WR8DCO	BPR5ES	7422
WR8DC4	BPR6ES	7822
WR8DCX	BPR5ES-11	4424
WR8DCX+	BPR5ES-11	4424
WR8DP	BPR5ES	7422
WR8DPX	BPR5ES-11	4424
WR8E	BR6S	3522
WR8EC	BR6S	3522
WR8EP	BR6S	3522
WR8F	BP5S	3011
WR8FC	BP5S	3011
WR8FP	BP5S	3011
WR8HP	ZGR5C	6334
WR8LC	ZGR5A	5839
WR8LC+	ZGR5A	5839
WR8LTC+	BUR5ET	3377
WR9AO	BR5HS	3722
WR9C	BR5ES	4722
WR9CC	BR5ES	4722
WR9D	BPR5ES	7422
WR9D+	BPR5ES	7422
WR9DC	BPR5ES	7422
WR9DC+	BPR5ES	7422
WR9DCX	BPR6ES-11	4824
WR9DCX+	BPR6ES-11	4824
WR9DCY	BPR5ES-13	3154
WR9DP	BPR5ES	7422
WR9DPX	BPR5ES-11	4424
WR9E	BR6S	3522

BOSCH	NGK → STOCK No.	
WR9EO	BR6S	3522
WR9EC	BR6S	3522
WR9ECO	BM6	2027
WR9F	BP5S	3011
WR9FC	BP5S	3011
WR9FP	BP5S	3011
WR9HC	ZGR5C	6334
WR9HP	ZGR5C	6334
WR9LE	ZGR5A	5839
WR9LS	ZGR5A	5839
WS5E	BM7A	6521
WS5F	BPM7A	7321
WS7E	BM6A	5921
WS7F	BPM6A	7021
WS8E	BM6A	5921
WS8F	BPM6A	7021
WSR5F	BPMR7A	4626
WSR6E	BMR6A	7421
WSR6F	BPMR6A	6726
WSR7E	BMR6A	7421
WSR8E	BMR6A	7421
WSR8F	BPMR6A	6726
WSR9E	BMR4A	5728
X3CPO	D9EA	2420
X4CC	D8EA	2120
X4CS	D8EA	2120
X5DC	D7EA	7912
XR2AS	DR8HS	5123
XR2CE0	DR9EA	3437
XR2CS	DR8ES	5423
XR2DDC	JR9C	6193
XR4AS	DR8HS	5123
XR4CS	DR8ES	5423
XR4DC	DPR8EA-9	4929
XR5DC	DPR7EA-9	5129
XR7DC	DPR7EA-9	5129
Y5KPP332S	PZKER7A8EGS	94968
Y6NPP332	PLKR7B8E	94716
Y6LER	ZKER6A-10EG	96596
Y7LER02	ZKER6A-10EG	96596
Y7MPP33	PLKR7A	4288
YR5DII33S	IKR9J8	93311
YR5DDE	KR9CI	7795
YR5LDE	DCPR8EKC	7168
YR5NDE	LKR8A	5214
YR6DES	DCPR7EA-9	6651
YR6KI332S	DCPR8EIX	6546
YR6LDE	DCPR8EKC	7168
YR6NI332S	LKAR8AI-9	6706
YR6NPP332	PLKR7B8E	94716
YR8SEU	LZKR6B-10E	1578
YR6TII330T	ILZKR7A	1961
YR7DC	DCPR7E-N-10	4983
YR7DC+	DCPR7E-N-10	4983
YR7DE	DCPR8E-N	5692
YR7LPP332W	IZKR7B	7563
YR7MII33X	SILKR6C10E	97098
YR7MPP33	PLKR7A	4288
YR7NE	LKR7B-9	5847
YR8MEU	LKR6D-10E	96569
YR8SEU	LZKR6B-10E	1578
YR8SII30W	LZKR6AI-10G	97999
ZGR6STE2W	ZKBR7A-HTU	91785
ZMR5TPP33	SILZKBR8D8S	97506
ZQR8SI302	PLZKBR7B8DG	90223
ZR5TPP330	SILZKBR8D8S	97506
ZR7SI332S	PLZKBR7B8DG	90223
BRIGGS & STRATTON NGK → STOCK No.		
BS19LM	B2LM	1147
BS19LMR	BR2LM	5798
BS-SV	BR2LM	5798
BS-SVCU	BR2LM	5798
BS-OHV	BCPR5ES	6130

BRIGGS & STRATTON NGK → STOCK No.		
BS-OHV-HT	BCPR5ES	6130
491043	BCPR5ES	6130
491055E	BCPR5ES	6130
491055S	BCPR5ES	6130
492167	BR2LM	5798
496018E	BCPR5ES	6130
496018S	BCPR5ES	6130
591868	BR2LM	5798
6093E	BCPR5ES	6130
6099E	BR2LM	5798
696202	BKR5EVX	2546
692720	BCPR5ES	6130
691043	BCPR5ES	6130
692051	BCPR5ES	6130
692720	BCPR5ES	6130
694385	BKR5EVX	2546
697451	BR2LM	5798
711252	BCPR5ES	6130
796112S	BR2LM	5798
797434	BCPR5ES	6130
799876	BPMR6A	6726
802592S	BR2LM	1147
992039	BR2LM	5798
992041	BR2LM	5798
992300	BR2LM	5798
992300C	BR2LM	5798
992301	BR2LM	5798
992301C	BR2LM	5798
992302	BR2LM	5798
992304	BCPR5ES	6130
992305	BCPR5ES	6130
992306	BCPR5ES	6130
992340	BCPR5ES	6130
992359C	BR2LM	5798
992360C	BR2LM	5798
992361	BCPR5ES	6130
992362	BCPR5ES	6130
BRISK		
77-300	BPM7A	7321
77-301	BR2LM	5798
77-302	BMA	5921
77-303	BCPR5ES	6130
77-304	BM6F	6221
77-305	BR2LM	5798
77-306	BMR6A	7421
77-307	BPMR7A	4626
77-308	BMTA	6521
77-309	BPM6A	7021
77-310	BP5ES	6511
77-311	BPM7A	7321
77-312	BPR6ES	7822
77-313	B4LM	3410
77-314	BPR5ES	7422
77-315	BP6ES	7811
77-316	BM7F	6421
77-317	B6S	3510
77-318	BPM6F	5950
77-319	BPMR4A	6028
77-320	BP4HS	3611
77-321	B6HS	4510
77-323	BES	2411
77-324	BPMR7A	4626
77-325	BPR6HS	7022
77-350	BR4LM	4133
77-351	B6S	3510
77-352	BP5HS	4111
77-354	BMR7A	4226
AR08GS	R0045Q-10	4216
AR08S	CR10E	6264
AR10S	CR9E	6263
AR12YS	CPR8E	7411
AR14YS	CR7E	4578
B10C	D9EA	2420

BRISK	NGK → STOCK No.	
B12C	D8EA	2120
B12YC	DPR9EA-9	5329
B14C	D7EA	7912
B14YC	DPR8EA-9	4929
B15YC	DPR7EA-9	5129
BR10S	DR9EA	3437
BR10YS-9	DPR9EIX-9	5545
BR12S	DR8EA	7162
BR12YC	DCPR8E	4339
BR12YC-9	DCPR8E	4339
BR12YP	DCPR8EIX	6546
BR14S	DR7ES	3123
BR14YC	DCPR7E	3932
BR14YC-9	DCPR7EA-9	6651
BR15YC	DCPR6E	3481
D12YC	BCP7ES	5030
D14Y	BKR6E	6962
D14YC	BCP7ES	5030
D15Y	BKR6E	6962
D15YC	BCP6ES	4930
D17Y	BKR5E	7938
D17YC	BCP5ES	7496
DOX15LE	ZFR6T-11G	5960
DR12YC	BKR7E	6097
DR14YC	BCPR7ES	3330
DR14ZC	ZFR7F-11	2975
DR14ZC-1	BCPR7ES-11	1095
DR15TC	BKUR5ET-10	7553
DR15YC	BKR6E	6962
DR15Z	BKR6E	6962
DR15Z-1	BCPR6ES-11	7121
DR17YC	BCPR5ES	6130
F14YC	AP7FS	2127
F15YC	AP6FS	2710
FR14YC	APR6FS	2922
FR15YC	APR6FS	2922
G12YC	BP7EFS	3526
G14Y	BP7EFS	3526
G14YC	BP7EFS	3526
G15Y	BP6EFS	3812
G15YC	BP6EFS	3812
G17Y	BP5EFS	3712
G17YC	BP5EFS	3712
GR15YC	BPR6EFS	3623
GR17YC	BPR5EFS	2223
J17	B4LM	3410
J19	B2LM	1147
JR17	BR4LM	4133
JR19	BR2LM	5798
K17C	B6S	3510
K17Y	BP5S	3011
K19	B4	3210
L08JW	BR10EIX	6801
L08W	B11EGV	5831
L10JW	BR8EIX	5044
L10SL	BR10EIX	6801
L11S	BR9ECM	3252
L11SL	B9EG	3530
L12W	BR9EIX	3981
L12Y	BP9ES	7526
L12YC	BP9ES	7526
L14	B8ES	2411
L14C	B8ES	2411
L14Y	BP6ES	7811
L14YC	BP7ES	2412
L15	B7ES	1111
L15C	B7ES	1111
L15W	BR8EIX	5044
L15Y	BP6ES	7811
L15YC	BP6ES	7811
L17	B6ES	7310
L17C	B6ES	7310
L17W	BR7EIX	6664
L17Y	BP5ES	6511

BRISK	NGK → STOCK No.	CARLTON	NGK → STOCK No.	CHAMPION	NGK → STOCK No.	CHAMPION	NGK → STOCK No.
L17YC	BP5ES 6511	71055	B5HS 4210	A8	D7EA 7912	F62Y	AP8FS 2227
L19C	B5ES 6410	71060	B4 3210	BL4	B7FS 3027	F7Y	AP7FS 2127
LR10S	BR10EG 3830	71065	B4H 4110	BL5	B7FS 3027	F7YC	AP7FS 2127
LR10SL	BR10EG 3830	71070	BPMR6A 6726	BL7Y	BP7FS 3612	F7YCC	AP7FS 2127
LR11S	BR9ECM 3252	C10S	B4H 4110	BL9Y	BP6FS 3512	F81Y	AP8FS 2227
LR11SL	BR9EG 3230	C7S	B6HS 4510	BL11Y	BP5FS 3412	F82	A8FS 4489
LR12C	BR9ECM 3252	C8S	B5HS 4210	BL13Y	BP5FS 3412	F83Y	AP8FS 2227
LR12SL	BR9EG 3230	C9	B4 3210	BN2	B9EFS 1085	F9Y	AP6FS 2710
LR12YC	BPR8ES 3923	CA5E	BM7A 6521	BN6Y	BP7EFS 3526	F9YC	AP6FS 2710
LR12ZC	BPR8ES 3923	CA5Y	BPM7A 7321	BN7Y	BP6EFS 3812	FN507Y	BGP7ES 5030
LR14TXS	BUR6ET 3172	CA6	BPMR6A 4626	BN9Y	BP6EFS 3812	G1	C9E 7499
LR14YC	BPR7ES 2023	CA7E	BM7A 6521	BN12Y	BP5EFS 3712	G2	C8E 7471
LR14ZC	BPR7ES 2023	CA7Y	BPM7A 7321	BN89Y	BP6EFS 3812	G54V	R0045J-10 7400
LR14ZC-1	BPR7ES-11 7226	CA8E	BM6A 5921	C10YCC	BCP6ES 4930	G55	C9E 7499
LR15TXS	BP5ET 2287	CA8Y	BPM6A 7021	C11YCC	BCP5ES 7496	G56R	R0373A-10 4940
LR15YC	BPR6ES 7822	CN6E	BM7F 6421	C12YCC	BCR5E 7938	G58	C9E 7499
LR15Z	BPR6ES 7822	CN8E	BM6F 6221	C281YC	BCP6ES 4930	G61	C8E 7471
LR15Z-1	BPR6ES-11 4824			C53	R7436-10 4900	G63	C8E 7471
LR17YC	BPR5ES 7422	CATERPILLAR	NGK → STOCK No.	C53VC	R6601-10 4017	H03	B6S 3510
MR12YS-9	LKAR8AI-9 6706	0007954	AB-6 2910	C55	R7436-10 4900	H10	B6L 3212
N08W	BR10HIX 6692	0041663	AB-6 2910	C55VC	R6601-10 4017	H10C	B6L 3212
N10S	BR10HIX 6692	0099476	BMR6A 7421	C57	R7436-9 4899	H10J	B6L 3212
N11S	BR9HS 4522	0631202	AB-6 2910	C57C	R7436-9 4899	H11	B4L 3112
N12W	BR9HIX 5687	0676637	AB-6 2910	C57VC	R6601-10 4017	H12	B4L 3112
N12Y	BP8HS 2630	0971353	BP2ES 3467	C57Y	BKR9EIX 2669	H8	B6L 3212
N12YC	BP8HS 2630	0972385	AB-6 2910	C57YC	BKR9EIX 2669	H8C	B6L 3212
N14	B8HS 5510	0973283	AB-6 2910	C59	R7436-9 4899	H8J	B6L 3212
N14C	B7HS 5110	1017268	BPR4ES 7222	C59C	BCR8ES 5430	J11	B4 3210
N14Y	BP6HS 4511	1038083	BPR5ES 7422	C59YC	R7435-9 4896	J11C	B4 3210
N14YC	BP7HS 5111	141267	BMR6A 7421	C6BYC	BCP7ET 2078	J11J	B4 3210
N15	B6HS 4510	2A3643	AB-6 2910	C6BYC4	BCP7ET 2078	J11Y	BP5S 3011
N15C	B7HS 5110	216460	BPR5FS 2423	C6VPC	BKR7EIX 2667	J12J	B2 3110
N15W	BR8HIX 7001	2W9486	BP5EY 7327	C6YCC	BCP7ES 5030	J12Y	BP5S 3011
N15Y	BP6HS 4511	353706	AB-6 2910	C6YCX	BCP7ES 5030	J12YC	BP5S 3011
N15YC	BP6HS 4511	8N2236	BMR6A 7421	C61	R7436-8 4898	J13Y	BP5S 3011
N17	B5HS 4210	8N2630	AB-6 2910	C61C	R7436-8 4898	J14J	B2 3110
N17C	B6HS 4510	851101	BMR6A 7421	C7	AB6 2910	J14Y	BP5S 3011
N17W	BR7HIX 7067	90420-01620	PTR5D-10 3784	C7Y	BCP7ES 5030	J14YC	BP5S 3011
N17Y	BP4HS 3611	91220-00400	BPR4ES 7222	C7YC	BCP7ES 5030	J17LM	B4LM 3410
N17YC	BP5HS 4111	91H20-02860	BCPR5E-11 1273	C7YCC	BCP7ES 5030	J18Y	BP4 2911
N19	B5HS 4210	997476	BMR6A 7421	C7YCX	BCP7ES 5030	J18YC	BP4 2911
N19C	B5HS 4210	99476	BMR6A 7421	C9MCC	ZFR5F 5165	J19LM	B2LM 1147
NAR12YS	CR8HS 7423	A0000-14416	BPR6EFS 3623	C9Y	BCP6ES 4930	J4	B7S 3710
NAR14YC	CR7HS 7223	MD851101	BMR6A 7421	C9YC	BCP6ES 4930	J4C	B7S 3710
NAR14YS	CR7HS 7223	MD997476	BMR6A 7421	C9YCC	BCP6ES 4930	J4J	B7S 3710
NAR15YS	CR6HS 7023	MS851101	BP5EY 7327	C9YCX	BCP6ES 4930	J5	B7S 3710
NR12YC	BPR8HS 3725			CJ11	BM6A 5921	J6	B6S 3510
NR14C	BR7HS 4122	CHAMPION	NGK → STOCK No.	CJ14	BM4A 5628	J6C	B6S 3510
NR15YC	BPR6HS 7022	2071	BCPR5ES 6130	CJ17LM	B4LM 3410	J6J	B6S 3510
P15	BM7A 6521	3071	BKR5EVX 2546	CJ3	BM7A 6521	J7	B6S 3510
P15Y	BPM7A 7321	3401	ITR6F13 4477	CJ4	BM7A 6521	J7J	B6S 3510
P17	BM6A 5921	4 COM	AB7 3010	CJ6	BM7A 6521	J8	B6S 3510
P17Y	BPM6A 7021	5 COM	AB7 3010	CJ6Y	BPM7A 7321	J8C	B6S 3510
P18Y	BPM7A 7321	7 COM	AB6 2910	CJ7Y	BPM7A 7321	J8J	B6S 3510
PR15	BMR7A 7321	8 COM	AB6 2910	CJ8	BM6A 5921	K11	AB6 2910
PR15Y	BPMR7A 4626	A10	D7EA 7912	CJ8Y	BPM6A 7021	K13	AB6 2910
PR17	BMR6A 7421	A2HC	DPR9EA-9 5329	CJ86	BM6A 5921	K15J	AB6 2910
PR17Y	BPMR6A 6726	A26	AB6 2910	CCH9013	IZFR5R7G 94123	K3G	AB8 7909
PR18Y	BPMR7A 4626	A51R	R2525-10 5281	D10	AB6 2910	K5G	AB8 7909
U15	BM7F 6421	A55C	R2525-10 5281	D14	AB6 2910	K7	AB8 7909
U17	BM6F 6221	A55R	R2525-10 5281	D16	AB6 2910	K8	AB8 7909
		A57C	R2525-10 5281	D16J	AB6 2910	K8G	AB8 7909
		A57G	R2525-10 5281	D21	AB6 2910	K9	AB7 3010
		A57R	R2525-10 5281	D23	AB6 2910	KA6ZPHPB-1	PZKER7A8EGS 94968
		A59C	DCR9EIX 6650	D6	AB8 7909	KA8ZYCC-1	ZKER6A-10EG 96596
		A59G	DCR9EIX 6650	D9	AB6 2910	KC10PYPB4	PFR5G-11 2647
		A59GC	DCR9EIX 6650	D9J	AB6 2910	KC6PYPBX	PFR7Q 7963
		A5YC	DPR9EA-9 5329	D9JM	AB7 3010	KC7PYPB	PFR7W-TG 5592
		A6	D8EA 2120	DJ6J	BM7F 6421	KC7ZPMPBX4	PZFR5N-11T 7742
		A61	D9EA 2420	DJ6Y	BPM7F 1268	KC7ZPYPB4	PZFR6R 5758
		A61G	DR9EIX 4772	DJ7J	BM6F 6221	KC7ZTMC4	BKUR6ET-10 2397
		A6G	DR8EIX 6681	DJ7Y	BPM6F 5950	KC8PYP4	PFR5G-11 2647
		A6GC	DR8EIX 6681	DJ8J	BM6F 6221	KC8WYP4	IFR6D10 5344
		A65	AB6 2910	E82	A7FS 2976	KC8ZMCC	ZFR5P-G 6893

CHAMPION	NGK → STOCK No.	CHAMPION	NGK → STOCK No.	CHAMPION	NGK → STOCK No.	CHAMPION	NGK → STOCK No.
KC8ZPYPB4	PZFR5N-11T 7742	N2	B9ES 2611	OE002	BKR6E 6962	OE076	BCP7ET 2078
KEC6PYPB-1	PLFER7A8EG 94833	N21	B4ES 4129	OE003	BCP6ES 4930	OE077	BCPR6ET 2197
KEC6WYYPB-1	PLFER7A8EG 94833	N2C	B9ES 2611	OE004	BPR6ES 7822	OE078	BR8EIX 5044
KER4PYYPB	PLKR7A 4288	N2G	BR9EIX 3981	OE005	BKR6E 6962	OE079	B7ES 1111
L10	B6HS 4510	N279YC	BP7ES 2412	OE006	BPR6ES 7822	OE080	BKR7E-11 1283
L10S	B6HS 4510	N281YC	BP6ES 7811	OE007	BP6HS 4511	OE081	BKR6E-11 2756
L11S	B7HS 5110	N288	B5ES 6410	OE008	BPR7ES 2023	OE082	BP7EFS 3526
L12Y	BP5HS 4111	N3	B8ES 2411	OE009	BP6EFS 3812	OE084	BP8ES 2912
L14	B4H 4110	N3C	B8ES 2411	OE010	BP7ES 2412	OE085	BKR5EKU 3964
L15Y	BP4HS 3611	N3G	BR8EIX 5044	OE011	BPR6EFS 3623	OE086	BR6HS 3922
L19V	BUH 2422	N4	B7ES 1111	OE012	BP6ET 1263	OE087	BP8ES 2912
L2G	BR9HIX 5687	N4C	B7ES 1111	OE013	BKR5E 7938	OE088	BCPR6ES 2330
L20V	BUH 2422	N4G	BR7EIX 6664	OE014	BKR7E 6097	OE089	ZFR6F-11 4291
L288	B5HS 4210	N4YC	BP9ES 7526	OE015	BP5ES 6511	OE090	BP7EFS 3526
L3G	BR8HIX 7001	N5	B6ES 7310	OE016	BKR6E 6962	OE091	BR9ES 5722
L4G	BR7HIX 7067	N5C	B6ES 7310	OE017	BCP7ES 5030	OE092	CR9E 6263
L4J	B7HS 5110	N52R	B11EGP 2191	OE018	BPR7ES 2023	OE093	BKR6ES 3783
L5	B7HS 5110	N54R	B10EGP 5224	OE019	BKR5EK 7956	OE094	BCPR7ES 3330
L55G	BR10HIX 6692	N55G	B10SEGV 2171	OE020	BPR6EFS 3623	OE095	BP6ET 1263
L6G	BR7HIX 7067	N56R	B11EGP 2191	OE021	BCPR6ET 2197	OE096	B6HS 4510
L61Y	BP8HS 2630	N57	BR10ES 4832	OE022	BP6ES 7811	OE098	BR7ES 5122
L64Y	BP7HS 5111	N57G	B10SEGV 2171	OE023	BCP6ES 4930	OE099	BP5EFS 3712
L66Y	BP6HS 4511	N57R	B10EGP 5224	OE024	BCPR6ES-11 7121	OE100	BPR5EKU 5685
L7	B6HS 4510	N58R	B10EGP 5224	OE025	BUR6ET 3172	OE101	BPR5ES-11 4424
L7J	B6HS 4510	N59G	BR10EIX 6801	OE026	BKR6EK 2288	OE102	BKR6EKE 5649
L76V	BUHW 2622	N6	B6ES 7310	OE027	BUR5ET-10 7264	OE104	BP6HS 4511
L77J	B7HS 5110	N6BYC	BP6ET 1263	OE028	BP5ET-10 5156	OE106	BP5ES 6511
L77J4	B7HS-10 2129	N6GY	BPR8EIX 6684	OE029	PTR5A-10 5055	OE107	BPR7ES-11 7226
L77JC	B7HS 5110	N6Y	BP8ES 2912	OE030	BKR6EKC 2848	OE108	BR8ES 5422
L77JC4	B7HS-10 2129	N6YC	BP8ES 2912	OE031	TR5A-10 0005	OE109	BP6ES 7811
L77V	BUHW 2622	N6YCC	BP8ES 2912	OE032	BKUR6ET-10 2397	OE110	BCPR7ES 3330
L78	B7HS 5110	N6O	B9ES 2611	OE033	BKR6EZ 4619	OE111	BPR6ES 7822
L78C	B7HS 5110	N6OR	B8EGP 2046	OE034	BKR6EZ 4619	OE112	DR8EIX 6681
L78V	BUHW-2 5626	N62R	B8EGP 2046	OE035	LF5B 7113	OE113	BPR6ES-11 4824
L81	B7HS 5110	N63Y	BP9ES 7526	OE036	BP6EFS 3812	OE115	FR5-1 7252
L81Y	BP7HS 5111	N64Y	BP8ES 2912	OE037	B6HS 4510	OE116	BPR8ES 3923
L82	B6HS 4510	N65Y	BP7ES 2412	OE038	BP6HS 4511	OE117	BPR7ES-11 7226
L82C	B6HS 4510	N66Y	BP6ES 7811	OE039	BCPR6ES-11 7121	OE118	BCPR6ET 2197
L82Y	BP6HS 4511	N7	B7ES 1111	OE040	B9ES 2611	OE119	BKR6E 6962
L82YC	BP6HS 4511	N7BMC	BP6ET 1263	OE041	FR5-1 7252	OE121	BKR5E 7938
L82YCC	BP6HS 4511	N7BYC	BP6ET 1263	OE042	BPR5ES 7422	OE122	PMR8A 5851
L85	B6HS 4510	N7GY	BPR7EIX 4055	OE043	BCPR7ES 3330	OE125	BR9EIX 3981
L85Y	BP6HS 4511	N7Y	BP7ES 2412	OE044	BP6ET 1263	OE126	PFR7B 4853
L86	B6HS 4510	N7YC	BP7ES 2412	OE045	BPR5ES 7422	OE127	BKR6E 6962
L86C	B6HS 4510	N7YCC	BP7ES 2412	OE046	BP7ES 2412	OE128	ZFR5F-11 2262
L86CC	B6HS 4510	N7YCX	BP7ES 2412	OE047	BPR6ES-11 4824	OE129	BKR7EIX 2667
L87C	B6HS 4510	N79Y	BP6ES 7811	OE048	BPR6ES-11 4824	OE130	LZKAR7A 6799
L87Y	BP6HS 4511	N8	B6ES 7310	OE049	BPR5ES-11 4424	OE131	PTR5D-10 3784
L87YC	BP6HS 4511	N8B	B6ES 7310	OE050	BP7EFS 3526	OE134	BKR6EP-13 2550
L87YCC	BP6HS 4511	N8GY	BPR6EIX 6637	OE051	BPR5ES 7422	OE135	LF84AP-11 5613
L88A	B6HS 4510	N8L	ZGR5C 6334	OE052	DCPR8E-N 5692	OE136	PFR6J-11 2743
L89CM	BP5HS 4111	N8Y	BP6ES 7811	OE053	APR6FS 2922	OE137	BKR5E-11 6953
L9J	B6HS 4510	N8O	B10EG 3630	OE054	APR6FS 2922	OE138	PFR6N-11 3546
L90	B5HS 4210	N8OG	B11EGV 5831	OE055	BP5ES 6511	OE141	BKR6EIX 6418
L90C	B5HS 4210	N82	B10EG 3630	OE056	BKR7E-11 1283	OE143	PFR6G-9 4377
L92Y	BP5HS 4111	N82G	B10SEGV 2171	OE057	BCP5ES 7496	OE144	BKR6EIX 6418
L92YC	BP5HS 4111	N84	B9EG 3530	OE058	BCP7ES 5030	OE145	BKR6EIX 6418
L95Y	BP4HS 3611	N84G	BR10EIX 6801	OE059	BP5HS 4111	OE146	PFR6N-11 3546
N1	BR10ES 4832	N86	B9EG 3530	OE060	ZGR5B 7345	OE147	ZFR6F-11 4291
N1C	BR10ES 4832	N86G	BR9EIX 3981	OE061	AP7FS 2127	OE148	LF85A-11 6376
N10PY	BPR6EIX 6637	N87	B8EG 3430	OE062	BKR6E-11 2756	OE150	PMR8A 5851
N10Y	BP6ES 7811	N87G	BR8EIX 5044	OE063	BKR6E-11 2756	OE151	BPR5EFS 2223
N10Y4	BPR6ES-11 4824	N9BMC	BPR5EKU 5685	OE064	BPR6HS 7022	OE152	BKR6E-11 2756
N11Y	BP5ES 6511	N9BYC	BP6ET 1263	OE065	BP5ES 6511	OE153	BKR5EZ 7542
N11YC	BP5ES 6511	N9BYC4	BP5ET-10 5156	OE066	ZFR6F-11 4291	OE154	ZFR5F-11 2262
N11YCC	BP5ES 6511	N9Y	BP6ES 7811	OE067	BP7EFS 3526	OE155	APR6FS 2922
N12Y	BP5ES 6511	N9YC	BP6ES 7811	OE068	B8ES 2411	OE156	ZGR5C 6334
N12YC	BP5ES 6511	N9YC4	BPR6ES-11 4824	OE069	BCP6ES 4930	OE157	BCR8ES 5430
N12YCC	BP5ES 6511	N9YCC	BP6ES 7811	OE070	BP6HS 4511	OE162	BR6ES 4922
N13L	ZGR5C 6334	N9YCX	BP6ES 7811	OE071	BPR6HS 7022	OE163	LZTR4A-11 5444
N13Y	BP5ES 6511	NA10	B8ES 2411	OE072	BP5EFS 3712	OE167	LZTR5AIX-13 2314
N14LY	ZGR5C 6334	NA8	B6ES 7310	OE073	DCPR9E 2641	OE168	PTR5D-10 3784
N14Y	BP5ES 6511	OBL9Y	BPR6FS 2623	OE074	B6ES 7310	OE171	BPR6FS 2623
N19V	BUE 2322	OE001	BP6ES 7811	OE075	BCP7ES 5030	OE175	LF85AP-11 4775

CHAMPION	NGK → STOCK No.	CHAMPION	NGK → STOCK No.	CHAMPION	NGK → STOCK No.	CHAMPION	NGK → STOCK No.				
OE176	PZFR5D-11	7968	QC12YC	BKR5E	7938	RC10MCC	ZFR6V-G	8894	RC9MC4	ZFR5F-11	2262
OE178	LF85B	7113	QC501V	R7434-10	4894	RC10MCC6	ZFR6V-G	8894	RC9MCC4	ZFR6F-11	4291
OE179	IFR6J11	7658	QC59C	BCR8ES	5430	RC10MCCR6	ZFR6V-G	8894	RC9QMP	BKR6EQUIP	3199
OE181	IFR6D10	5344	QC9MC4	ZFR6F-11	4291	RC10PYC	BKR6EIX	6418	RC9Y	BKR6E	6962
OE182	IFR6T11	4589	QCJ8Y	BPMR6A	6726	RC10PYP4	PFR5J-11	4642	RC9YC	BKR6E	6962
OE183	IFR6F13	4477	QJ19LM	BR2LM	5798	RC10PYPB4	PFR5G-11	2647	RC9YC4	BCPR6ES-11	7121
OE184	IZFR5B	4080	QL16V	BUZ8H	7447	RC10VTYC4	BKUR5ET-10	7553	RC9YC5	BCPR6ES-11	7121
OE185	IZFR6B	3116	QL7J5	BR6HS	3922	RC10WMP2	IZFR5B	4080	RC9YCC	BKR6E	6962
OE186	DCPR7E-N-10	4983	QL76V	BUZHW	2147	RC10WMB3	IZFR5R7G	94123	RC9YCC4	BCPR6ES-11	7121
OE188	IFR6T11	4589	QL77CC	BZ7HS-10	3579	RC10WYP4	IFR5N10	7866	RCJ4	BMR7A	4226
OE190	ILFR6B	6481	QL77J4	BZ7HS-10	3579	RC10YCC	BCPR6ES	2330	RCJ501H	BPMR4A	6028
OE191	IFR6D10	5344	QL77JC4	BZ7HS-10	3579	RC10YC4	BKR6E-11	2756	RCJ6	BMR7A	4226
OE192	PGR5C-11	5760	QL78C	BZ7HS-10	3579	RC10YCC	BKR6E	6962	RCJ6Y	BPMR7A	4626
OE195	IGR7A	6687	QL78V	BUZHW-2	2173	RC10YCC4	BKR6E-11	2756	RCJ6YC	BPMR7A	4626
OE196	DCPR7E-N-10	4983	QL82C	BR6HS	3922	RC10YCL	BKR5EZ	7642	RCJ7Y	BPMR7A	4626
OE197	LKR6D-10E	96569	QL82YC	BPR6HS	7022	RC11PYPB4	PFR6N-11	3546	RCJ7YC	BPMR7A	4626
OE198	ZFR6V-G	8894	QL86	BR6HS	3922	RC11ZYC4	ZFR5E-11	4435	RCJ8	BMR6A	7421
OE199	DCPR8E	4339	QL86C	BR6HS	3922	RC12ECC	FR5-1	7252	RCJ8Y	BPMR6A	6726
OE201	LZKR6B-10E	1578	QL87YC	BPR6HS	7022	RC12L2C	ZFR5F	5165	RCJ8YC	BPMR6A	6726
OE204	PLZKBR7B8DG	90223	QN2	BR9ES	5722	RC12L4C	ZFR5F-11	2262	RD14	AB6	2910
OE205	PLZKBR7B8DG	90223	QN2C	BR9ES	5722	RC12LYC	FR5-1	7252	RD16	AB6	2910
OE206	ILFR6B	6481	QN2G	BR9EIX	3981	RC12MC4	ZFR5F-11	2262	RD16J	AB6	2910
OE207	PLZKAR6A-11	5118	QN3	BR8ES	5422	RC12MC5	ZFR5F-11	2262	RD9	AB6	2910
OE208	IKR9J8	93311	QN3C	BR8ES	5422	RC12MCC4	ZFR5F-11	2262	RDJ7J	BMR6F	2144
OE209	PFR7W-TG	5592	QN84	BR9EG	3230	RC12PYC	PFR6B	3500	RDJ7Y	BPMR6F	1270
OE211	LKR8A	5214	QN86	BR8EG	3130	RC12PYP	BKR6EP-13	2550	RDJ8J	BMR6F	2144
OE212	LKR7B-9	5847	R10	D6EA	7512	RC12YC	BKR5E	7938	RE14MCC4	LZTR4A-11	5444
OE213	PZFR6R	5758	R6	D8EA	2120	RC12YC5	BKR5E-11	6953	RE14MCC5	LZTR4A-11	5444
OE217	BKR6EKE	5649	R6G	DR8EIX	6681	RC12YCC	BKR5E	7938	RE14PLP5	LZTR5AIX-13	2314
OE221	PLFER7A8EG	94833	R8	D7EA	7912	RC12YCC4	BKR5E-11	6953	RE7PYC5	PTR5A-10	5055
OE222	PFR7Q	7963	RA2HC	DPR9EA-9	5329	RC14YC	BKR5E	7938	RE7YCC	TR5A-10	0005
OE223	BKR6EQUIP	3199	RA2PYPB	IKR9J8	93311	RC6PYP	PFR7B	4853	REA4PMPB4	ILZKAR7A10	6043
OE224	ILFR6A	3588	RA4HC	DCPR8E	4339	RC6VPYC	BKR7EIX	2667	REA6PYPB	ILKAR7A7	91432
OE225	ILKAR7A7	91432	RA4HCC	DCPR8E	4179	RC6YC	BCPR7ES	3330	REA6YC	LKAR8A-9	4786
OE226	IKR6G11	7980	RA4HCX	DCPR8E-N	5692	RC6YCC	BCPR7ES	3330	REA8MCL	LZKAR7A	6799
OE227	IZFR6B	3116	RA4YC	DCPR8E	4179	RC61YC	BCR8ES	5430	REA8MCX	LZKAR7B	5942
OE228	PFR5G-11	2647	RA59GC	DCR9EIX	6650	RC7BMC	BCPR6ET	2197	REA8MX	LZKAR7B	5942
OE229	PLKR7A	4288	RA6	DR8ES-L	2923	RC7BYC	BKR6EKUB	3584	REA8PMPB5	PLZKAR6A-11	5118
OE230	DCPR8E	4179	RA6HC	DCPR8E	4339	RC7BYC4	BCPR6ET	2197	REA8WYPB4	ILKAR7A11	94124
OE231	LKAR8A-9	4786	RA6Y	DPR8EA-9	4929	RC7GYC	BKR7EIX	2667	REA12WMB4	LZKAR6AP-11	6643
OE232	ILKR9G8	97168	RA6YC	DPR8EA-9	4929	RC7PYCB	BKR6EIX	6418	REC10PYC4	LF85AP-11	4775
OE233	ILZKAR7A10	6043	RA7PYPB4	IKR6G11	7980	RC7PYCB4	PFR6B-11	4014	REC10WYPB4	ILFR6B	6481
OE234	PZFR5N-11T	7742	RA7YC	DCPR8E	4339	RC7Y	BCPR7ES	3330	REC10YC4	LF85A-11	6376
OE235	BKUR6ET-10	2397	RA8HC	DCPR7E	3932	RC7YC	BCPR7ES	3330	REC14PLP5	LZTR5AIX-13	2314
OE236	LF86D	4704	RA8MCX4	ZKR7A-10	1691	RC7YC3	BKR7E	6097	REC14PYC	LF84AP-11	5613
OE237	BKR6EKUB	3584	RA8Y	DPR7EA-9	5129	RC7YC4	BKR7E-11	1283	REC6TMC	LF86D	4704
OE238	PLZFR6A11S	5987	RA8YC	DPR7EA-9	5129	RC7YCC	BCPR7ES	3330	REC7PMPB4	PLZFR6A11S	5987
OE239	IZFR6K-11S	5266	RA8YCX4	DCPR7E-N-10	4983	RC7YCC4	BKR7E-11	1283	REC8PYB	ILFR6B	6481
OE240	LZKAR6AP-11	6643	RAX92C	DR9EA	3437	RC7YCC4	BKR7E-11	1283	REC8PYPB	ILFR6A	3588
OE241	CR9EB	6955	RAX92DC	JR9C	6193	RC78PYP	PFR7G-11S	7772	REC9MCLX	LF85B	7113
OE243	SILZKBR8D8S	97506	RAX92YC	DPR9EA-9	5329	RC8BYC	BKR6EKC	2848	REC9YCL	LF85B	7113
OE244	PZKER7A8EGS	94968	RAX94C	DR8EA	7162	RC8DMC	BKR6EK	2288	RER2PYPB	ILKR9G8	97168
OE245	SILZKGR8B8S	94201	RAX94YC	DPR8EA-9	4929	RC8PMP8	IZFR6B	3116	RER6YC	LKR7B-9	5847
OE246	PLFER7A8EG	94833	RAX96C	DR7EA	7839	RC8PYCB	PFR6G-9	4377	RER8DMC	LKR8A	5214
OE247	ZKER6A-10EG	96596	RAX96YC	DPR7EA-9	5129	RC8PYP	PFR6J-11	2743	RER8MC	LZKR6B-10E	1578
OE253	ILKAR7A11	94124	RBL11Y	BPR5FS	2423	RC8PYPB4	PFR6N-11	3546	RER8WYPB	SILKR6C10E	97098
OE255	LTR6B-10T	5948	RBL11Y6	BPR5FS-15	3124	RC8PYX	BKR6EIX	6418	RER8WYPB4	SILKR6C10E	97098
OE258	SILZNR6D9	94051	RBL12	BR5FS	4123	RC8VTYC4	BKUR6ET-10	2397	RER8YC	LKR6D-10E	96569
OJ12Y	BP5S	3011	RBL13Y	BPR5FS	2423	RC8WMP2	IZFR6B	3116	RERX4ZWYPB	SILZKGR8B8S	94201
OJ13Y	BP5S	3011	RBL13Y6	BPR5FS-15	3124	RC8WMP4	IFR6T11	4589	RERX5ZPYPB	SILZKBR8D8S	97506
ON11Y	BPR5ES	7422	RBL15Y	BPR4FS	1127	RC8WYP4	IFR6J11	7658	RERX6PMPB4	PLZKBR7B8DG	90223
ON12Y	BPR5ES	7422	RBL15Y4	BPR4FS-11	2527	RC8YC	BKR6E	6962	RES9PYP4	PTR5A-10	5055
ON3	BR8ES	5422	RBL15Y6	BPR4FS-15	2727	RC8YCC	BKR6E	6962	RES9YCC4	TR5A-10	0005
P10Y	D6HA	6512	RBL16Y	BPR4FS	1127	RC8YCC4	BKR6E-11	2756	RES10TMC4	LTR6B-10T	5948
P7	D8HA	7112	RBL17Y	BPR4FS	1127	RC8YCL	BKR6EZ	4619	RET4WYPB	SILZNR6D9	94051
P8Y	D6HA	6512	RBL17Y6	BPR4FS-15	2727	RC8ZPYPB4	IZFR6K-11S	5266	RF11Y	APR6FS	2922
PG2PHP	PMR8A	5851	RBL8	BR6FS	4323	RC87LYC	BKR6E	6962	RF11YC	APR6FS	2922
PG4PHP	PMR7A	4259	RBL9Y	BPR6FS	2623	RC87PYC	BKR6EIX	6418	RF14Y	APR5FS	3122
P-G7C	C7E	5096	RBN12Y	BPR5EFS	2223	RC87YCC	BKR6ES	3783	RF14YC	APR5FS	3122
P-RG7C	CR7E	4578	RBN13Y	BPR5EFS	2223	RC87YCL	BKR6EZ	4619	RF7YC	APR6FS	2922
P-R29HC	CR7HSA	4549	RBN14Y	BPR5EFS	2223	RC89PYC	BKR6EIX	6418	RF7YCC	APR6FS	2922
PZ7HC	CR7HSA	4549	RBN9Y	BPR6EFS	3623	RC89WYP4	IFR6T11	4589	RF9Y	APR6FS	2922
Q504V	R2349-10	6839	RC10DMC	BKR5EK	7956	RC89YCC	BKR6ES	3783	RF9Y5	APR6FS	2922
QC12PEP	PZFR6H	7696	RC10ECC	ZFR6F-11	4291	RC9BMC	BKR5EKE	3964	RF9YC	APR6FS	2922

CHAMPION	NGK → STOCK No.	CHAMPION	NGK → STOCK No.	CHAMPION	NGK → STOCK No.	CHINESE BRANDS	NGK → STOCK No.				
RFN14LY	ZFR4F-11	4043	RN12YC4	BPR5ES-11	4424	S6YC	BP7EFS	3526	D8C	D8EA	2120
RG2PHP	CR8EIX	4218	RN12YC6	BPR5ES-13	3154	S6YCC	BP7EFS	3526	D8RC	DR8EA	7162
RG4HC	CR9EB	6955	RN12YCC	BPR5ES	7422	S7YC	BP7EFS	3526	D8RTC	DR8EA	7162
RG4HCX	CR9EB	6955	RN13L	ZGR5C	6334	S7YCC	BP7EFS	3526	D8TC	D8EA	2120
RG4PHP	PMR8A	5851	RN13LYC	ZGR5C	6334	S9YC	BP6EFS	3812	D9C	D9EA	2420
RG6PP	PMR8A	5851	RN14LY	ZGR5C	6334	S9YCC	BP6EFS	3812	D9RC	DR9EA	3437
RG6YC	CPR8E	7411	RN14MC5	BPR5EY-11	3028	UD16	AB6	2910	DK6RTC	DCPR6E	3481
RG6YCA	CPR8E	7411	RN14PMP5	BPR5EP-11	3971	UF-11Y	APR5FS	3122	DK7RTC	DCPR7E	3932
RG6YCH	CPR8E	7411	RN14Y	BPR5ES	7422	UF-14Y	APR5FS	3122	DK8RTC	DCPR8E	4339
RG92C	CR9E	6263	RN14Y6	BPR5ES-13	3154	UF-9Y	APR6FS	2922	E5C	B5HS	4210
RG92DC	CR9EK	4548	RN14YC	BPR5ES	7422	UJ12	B2	3110	E5RC	BR5HS	3722
RG94C	CR8E	1275	RN16Y	BPR4ES	7222	UJ18Y	BP4	2911	E5RTC	BPR5HS	6222
RGU92C	CR9EH-9	7502	RN2	BR9ES	5722	UJ2J	B8S	3810	E5T	BP5HS	4111
RGU94C	CR8EH-9	5666	RN2C	BR9ES	5722	UJ4J	B7S	3710	E5TC	BP5HS	4111
RH10C	B6L	3212	RN2G	BR9EIX	3981	UJ6	B6S	3510	E6C	B6HS	4510
RH18Y	B-4L	3112	RN3	BR8ES	5422	UJ8	B6S	3510	E6RC	BR6HS	3922
RJ11	BR6S	3522	RN3C	BR8ES	5422	UJ81C	B7S	3710	E6RTC	BPR6HS	7022
RJ11Y	BP5S	3011	RN3G	BR8EIX	5044	UJ81J	B7S	3710	E6T	BP6HS	4511
RJ12	BR6S	3522	RN4	BR7ES	5122	UK10	AB6	2910	E6TC	BP6HS	4511
RJ12C	BR6S	3522	RN4C	BR7ES	5122	UL17V	BUHXW-1	5526	E7C	B7HS	5110
RJ12Y	BP5S	3011	RN5	BR6ES	4922	UL18V	BUHX	2522	E7RC	BR7HS	4122
RJ12YC	BP5S	3011	RN5C	BR6ES	4922	UL4J	B7HS	5110	E7RTC	BPR7HS	6422
RJ14Y	BP5S	3011	RN57YC	BR10EG	3830	UL77V	BUHXW-1	5526	E7TC	BP7HS	5111
RJ14YC	BP5S	3011	RN57YCC	BR10EG	3830	UL81C	B7HS	5110	E8C	B8HS	5510
RJ17LM	BR4LM	4133	RN6	BR6ES	4922	UL81J	B7HS	5110	E8RC	BR8HS	4322
RJ18Y	BP4	2911	RN6Y	BPR8ES	3923	UN12Y	BP5ES	6511	E8RTC	BPR8HS	3725
RJ18YC	BP4	2911	RN6YC	BPR8ES	3923	UN19V	BUE	2322	E8TC	BP8HS	2630
RJ19HX	BR2LM	5798	RN7GY	BPR7EIX	4055	UN79Y	BP6ES	7811	F5TC	BP5ES	6511
RJ19LM	BR2LM	5798	RN7Y	BPR7ES	2023	V12YC	BP5FS	3412	F6C	B6ES	7310
RJ19LMC	BR2LM	5798	RN7YC	BPR7ES	2023	V4C	B7FS	3027	F6RC	BR6ES	4922
RJ2YLE	BPMR6A	6726	RN7YC4	BPR7ES-11	7226	V59C	R5673-9	3856	F6RJY	BUR6ET	3172
RJ20Y	BP4	2911	RN7YCC	BPR7ES	2023	V9YC	BP6FS	3512	F6RTC	BPR6ES	7822
RJ6	BR6S	3522	RN7YCC4	BPR7ES-11	7226	XC10YC	BCPR6ES	2330	F6TC	BP6ES	7811
RJ6C	BR6S	3522	RN8	BR5ES	4722	XC12YC	BCPR5ES	6130	F6TJC	BP6ET	1263
RJ6J	BR6S	3522	RN8L	ZGR5C	6334	XC92YC	BCPR5ES	6130	F7C	B7ES	1111
RJ7	BR6S	3522	RN8VTYC4	BUR6ET	3172	XJ4J	B7S	3710	F7RC	BR7ES	5122
RJ8	BR6S	3522	RN8WYP	IGR7A	6687	XJ-8	BR6S	3522	F7RTC	BPR7ES	2023
RJ8C	BR6S	3522	RN9GY	BPR6EIX	6637	XL-10	BR6HS	3922	F7T	BP7ES	2412
RJ8J	BR6S	3522	RN9LCC	ZGR5B	7345	XN-8	BR6ES	4922	F7TC	BP7ES	2412
RL12Y	BPR6HS	7022	RN9Y	BPR6ES	7822	Y82	CM-6	5812	F8C	B8ES	2411
RL19	BR5HS	3722	RN9YC	BPR6ES	7822	Z10	C6HSA	3228	F8RC	BR8ES	5422
RL4J	BR7HS	4122	RN9YC4	BPR6ES-11	4824	Z12	C6HSA	3228	GL4	B4LM	3410
RL7J	BR6HS	3922	RN9YCC	BPR6ES	7822	Z6	C8HSA	6821	K5RF	BKR5E	7938
RL77J	BR7HS	4122	RN9YCC4	BPR6ES-11	4824	CHEVROLET	NGK → STOCK No.		K5RF-11	BKR5E-11	6953
RL78	BR7HS	4122	RP10HC	DR5HS	4623	25186682	ZFR6U-9	90318	K5RTC	BKR5E	7938
RL78C	BR7HS	4122	RP7	DR8HS	5123	CHINESE BRANDS	NGK → STOCK No.		K5RTC-11	BKR5E-11	6953
RL82	BR6HS	3922	RS12YC	BPR5EFS	2223	A5RC	CR5HS	2874	K6RF	BKR6E	6962
RL82C	BR6HS	3922	RS14YC	BPR5EFS	2223	A5RTC	CR5HS	2874	K6RF-11	BKR6E-11	2756
RL82Y	BPR6HS	7022	RS5C	BR7EFS	1094	A6C	C6HSA	3228	K6RTC	BKR6E	6962
RL82YC	BPR6HS	7022	RS8WYP5	ITR6F13	4477	A6RTC	CR6HSA	2983	K6RTC-11	BKR6E-11	2756
RL82YCC	BPR6HS	7022	RS9PYP4	PTR5D-10	3784	A6RC	CR6HSA	2983	K7C	BKR7E	6097
RL85	BR6HS	3922	RS9YC	BPR6EFS	3623	A6TC	C6HSA	3228	L4C	BM4A	5628
RL85C	BR6HS	3922	RS9YCC	BPR6EFS	3623	A7C	C7HSA	4629	L4RTC	BPMR4A	6028
RL86	BR6HS	3922	RV12C	BR5FS	4123	A7RC	CR7HSA	4549	L6C	BM6A	5921
RL86C	BR6HS	3922	RV12YC	BPR5FS	2423	A7RTC	CR7HSA	4549	L6RTC	BPMR6A	6726
RL87Y	BPR6HS	7022	RV12YC6	BPR5FS-15	3124	A7TC	C7HSA	4629	L6TC	BPM6A	7021
RL87YC	BPR6HS	7022	RV15YC	BPR4FS	1127	A7TCI	CR7HIX	7544	L7C	BM7A	6521
RL90	BR5HS	3722	RV15YC4	BPR4FS-11	2527	A8C	C8HSA	6821	L7RTC	BPMR7A	4626
RL95YC	BPR5HS	6222	RV15YC6	BPR4FS-15	2727	A8RC	CR8HSA	2086	L7TC	BPM7A	7321
RN1C	BR10ES	4832	RV17YC	BPR4FS	1127	A8RTC	CR8HSA	2086	L8RTC	BPMR8Y	2218
RN10GY	BPR6EIX	6637	RV17YC6	BPR4FS-15	2727	A8TC	C8HSA	6821	LR4C	BMR4A	5728
RN10PYP4	PGR5C-11	5760	RV19YC	BPR4FS	1127	B7	C7E	5096	LR6C	BMR6A	7421
RN10VTYC	BUR5ET	3377	RV8C	BR6FS	4323	B7R	CR7E	4578	LR7C	BMR7A	4226
RN10VTYC4	BUR5ET-10	7264	RV9YC	BPR6FS	2623	B7RD	CR7EK	7546	T1137C	C7HSA	4629
RN10Y	BPR6ES	7822	RZ7C	CMR7H	3066	B8	C8E	7471	T4197JC	BP7ES	2412
RN10YC	BPR6ES	7822	RZ94C	CR8HS	7423	B9	C9E	7499	CHRYSLER GROUP	NGK → STOCK No.	
RN10Y4	BPR6ES-11	4824	RZ98C	CR6HS	7023	B9R	CR9E	6263	04606402AB	LZTR4A-11	5444
RN11Y	BPR5ES	7422	RZN12Y	BPR5EFS	2223	B9RD	CR9EK	4548	04606591AB	ZFR5LP-13G	7781
RN11YC	BPR5ES	7422	RZN12Y5	BPR5EFS	2223	BM6A	BM6A	5921	SP070507AC	IKR9J8	93311
RN11YC4	BPR5ES-11	4424	S10YCC	BP5EFS	3712	CMR7H	CMR7H	3066	SPZFR5LP13G	ZFR5LP-13G	7781
RN11YCC	BPR5ES	7422	S12YC	BP5EFS	3712	D7C	D7EA	7912	SP000ZFR5N	ZFR5N	7917
RN11YCC4	BPR5ES-11	4424	S279YC	BP6EFS	3812	D7RC	DR7EA	7839	SPLZTR5A13	LZTR5AIX-13	2314
RN12Y	BPR5ES	7422	S281YC	BP6EFS	3812						
RN12YC	BPR5ES	7422	S379YC	BP7EFS	3526						

DENSO	NGK → STOCK No.	DENSO	NGK → STOCK No.	DENSO	NGK → STOCK No.	DENSO	NGK → STOCK No.
3268	BPR6HS-10 2633	4008	CR7HSA 4549	4186	ER10EH 2862	5375	DPR7EIX-9 7803
3270	PGR5A 3987	4009	C8HSA 6821	4187	CR10E 6264	5376	DPR8EIX-9 2202
3272	BPR7EKN 7738	4010	CR8HS 7423	4188	BPR8HS 3725	5377	DPR9EIX-9 5545
3273	PFR7B 4853	4012	B4H 4110	4189	CR8EIX 4218	5378	BPR6HIX 4085
3274	BPR8EIX 6684	4014	BP4HS 3611	4191	CR9EIX 3521	5379	BR7HIX 7067
3275	PFR5G-11 2647	4017	BR4HS 3322	4192	BPR5HS 6222	5380	BR8HIX 7001
3276	BK6E 3536	4018	BPR5EIX 6597	4196	C8E 7471	5383	CR7HIX 7544
3277	BPR6EKN 1128	4019	BP5HS 4111	4203	CR9EHIX-9 6216	5384	CR8HIX 7669
3279	BPR6EKN 1128	4021	BP7HS 5111	4206	CR8HSA 2086	5388	CR9EHI-9 6419
3280	BKR5E-11 6953	4022	BPR7HS 6422	4222	CR5EH-9 6689	5390	CR9EIA-9 6289
3281	BPR7EIX 4055	4024	BR7HS 4122	4223	CR8EB 7784	5391	BR8ECMIX 3520
3282	BCR8ES 5430	4025	B7HS 5110	4224	CR9EB 6955	5392	BR9ECMIX 2707
3284	PFR7G-11S 7772	4026	BR7HIX 7067	5008	APR5FS 3122	5393	BR10ECMIX 3006
3290	BKR7EIX 2667	4027	B7S 3710	5009	APR5FS 3122	5502	BPR6EIX-LPG 2347
3291	BPR6EIX 6637	4028	BP8ES 2912	5010	APR5FS 3122	5603	IFR5J11 7418
3293	BKR5EVX 2546	4030	B8ES 2411	5012	AP6FS 2710	5607	BPR7EIX 4055
3295	ZFR5A-11 5084	4032	BR8EIX 5044	5013	APR6FS 2922	5614	IJR7A9 7901
3297	IFR6T11 4589	4033	BR8ES 5422	5018	FR5-1 7252	5615	IFR6L11 3678
3302	PGR7A 3200	4034	B8EG 3430	5020	BPR4FS 1127	5616	IFR8H11 5068
3303	IFR5T-8N 3508	4035	BR8EG 3130	5021	BPR4FS-15 2727	5618	ILFR6J-11K 4458
3304	BKR6EKC 2848	4037	BR8HS 4322	5022	BPR5EFS 2223	5619	ILFR7H 5245
3306	PGR6A 4984	4038	B8HS 5510	5024	BP5FS 3412	5623	HB6AIX-11P 5703
3307	IFR6D10 5344	4039	BR8HIX 7001	5025	BPR5FS 2423	5625	HB6BIX-11P 5705
3310	BR10ET 7480	4040	B8S 3810	5026	BPR5FS-11 2924	5628	IFR5L11 6502
3311	ZFR5F-11 2262	4045	BR9ES 5722	5027	BPR5FS-15 3124	5629	IFR7L11 5114
3312	DCPR8E 4339	4046	B9ES 2611	5029	BR5FS 4123	5630	IFR9H11 6588
3313	DCPR9E 2641	4047	B9EG 3530	5031	BP6EFS 3812	5631	IMR9B-9H 4888
3314	DCPR9EIX 2316	4048	BR9EIX 3981	5032	BPR6EFS 3623	5633	IZFR6F11 4095
3315	BPR7EKN 7738	4052	B9HS 5810	5034	BP6FS 3512	5642	IMR9C-9HES 5766
3316	DCPR8EIX 6546	4053	BR9HIX 5687	5035	BPR6FS 2623	5701	R7434-8 4892
3319	BR8EQ 3328	4054	BR9HS 4522	5038	BR6FS 4323	5702	R7434-9 4658
3321	BPR6ES-11 4824	4057	BR10EIX 6801	5040	BP7EFS 3526	5703	R7434-10 4894
3322	BCPR6EP-N-11 4497	4063	BR10EIX 6801	5060	BKUR6ET 6437	5704	R7434-8 4892
3324	IFR5T11 4996	4067	BR10HIX 6692	5062	BKUR7ET 7873	5705	R7434-9 4658
3327	BCPR7ES-11 1095	4075	DR5HS 4623	5065	BP6ET 1263	5706	R7434-10 4894
3329	BKR5EKC 5216	4078	D6HA 6512	5067	BUR6ET 3172	5707	R7436-8 4898
3330	BKUR6ETB-10 5742	4080	DR6HS 4823	5068	PTR5A-10 5055	5708	R7436-9 4899
3335	IFR6T11 4589	4086	DPR7EA-9 5129	5069	BCP7ET 2078	5709	R7436-10 4900
3348	ZFR7F-11 2975	4090	D7EA 7912	5070	PTR5D-10 3784	5710	R7436-8 4898
3354	IGR7A 6687	4091	DR7ES 3123	5086	TR5A-10 0005	5711	R7436-9 4899
3356	IFR5E11 7994	4093	DPR8EA-9 4929	5087	ITR6F13 4477	5712	R7436-10 4900
3370	IZFR5G 5887	4096	DPR8EA-9 4929	5093	PTR5A-10 5055	5714	R7376-9 7763
3372	IFR7G-11KS 7746	4099	D8EA 2120	5301	BCPR5EIX-11 3306	5716	R7376-10 4457
3373	BKR6EP-8 2215	4101	DR8ES-L 2923	5302	BCPR6EIX-11 4919	5724	R7282A-105 4614
3374	ZFR6K-11 6711	4103	D8HA 7112	5303	BKR5EIX-11 5464	5725	R7282A-11 4754
3377	IZFR6K11 6994	4105	DR8HS 5123	5304	BKR6EIX-11 3764	5735	R0373A-9 3388
3378	ZFR6FIX-11 6441	4106	DPR8Z 4730	5306	BPR6EIX-11 3903	5736	R0373A-10 4940
3381	LFMR6C-11 5788	4111	DPR9EA-9 5329	5307	BPR7EIX 4055	5737	R0373A-11 5566
3392	PZFR6F-11 3271	4114	D9EA 2420	5308	DCPR7EIX 6046	5747	R7282-105 4985
3395	IFR5G-11K 3107	4116	DR8ES 5423	5309	DCPR8EIX 6546	5748	R7282-11 2001
3397	BKR5E-11 6953	4117	DPR9Z 4830	5310	BKR7EIX 2667	5749	R7438-8 4905
3401	IZFR6K13 6774	4123	B11EGV 5831	5311	BKR8EIX 2668	5750	R7438-9 4656
3402	BKR6E-11 2756	4126	CR8E 1275	5312	BKR9EIX 2669	5752	R7440B-10T 5009
3403	IFR6S 99404	4127	CR8EH-9 5666	5316	BR8EIX 5044	5753	R7440B-11T 5495
3411	BPR6EKN 1128	4128	C9E 7499	5317	BR9EIX 3981	5754	R7440A-9L 3795
3412	IFR5E11 7994	4129	CR9EH-9 7502	5319	BR10EIX 6801	5755	R7440A-10L 4282
3413	ZFR5F 5165	4131	CR9E 6263	5321	R7434-10 4894	6000	BUHX 2522
3417	ILFR5T11 96779	4135	CR10EK 2360	5326	BPR6EFIX-10 94658	6001	BUHW 2622
3418	IFR6E11 6741	4137	C7E 5096	5336	FR9BI-11 4709	6002	BUHW-2 5626
3419	IFR7G-11KS 7746	4155	CR9EK 4548	5337	DCPR9EIX 2316	6004	B2 3110
3421	ILFR6T11 4904	4158	CR8EK 3478	5338	LTR5IX-11 4344	6005	BP2ES 3467
3427	LZKAR7A 6799	4159	BR9ECM 3252	5339	PLTR6A-10G 3587	6009	B4ES 4129
3432	IZFR6K-11S 5266	4160	BR10ECS 5880	5345	ILFR7H 5245	6011	BPR4ES 7222
3439	PLZKAR6A-11 5118	4161	BPR6HSA 4632	5348	BKR7EIX 2667	6013	B4L 3112
3443	IFR6G11K 1314	4162	ER9EH 5869	5349	LZTR5AIX-13 2314	6015	BM4A 5628
3444	ILKAR7B11 4912	4168	BP7HS-10 7829	5351	BKR5EIX-11 5464	6018	BPMR4A 6028
3449	IFR6J11 7658	4169	CR10EIX 6482	5352	BKR6EIX-11 3764	6019	BMR4A 5728
3452	IKR6G11 7980	4171	CR5HS 2874	5361	CR7EIX 7385	6021	BP4 2911
4000	CR5HS 2874	4172	DR9EIX 4772	5362	CR8EIX 4218	6023	BPM6A 7021
4002	C6HSA 3228	4174	CR7E 4578	5363	CR9EIX 3521	6025	BMR6A 7421
4003	CR6HIX 7274	4175	BR8EIX 5044	5368	CR8EHIX-9 3797	6028	B9HS-10 3626
4004	CR6HSA 2983	4176	BR10ES 4832	5369	CR9EHIX-9 6216	6033	B4 3210
4006	C7HSA 4629	4178	BP8HS 2630	5372	DR8EIX 6681	6034	BM4A 5628
4007	CR7HIX 7544	4185	ER8EH 4011	5373	DR9EIX 4772	6035	B4LM 3410

DENSO	NGK → STOCK No.	DENSO	NGK → STOCK No.	DENSO	NGK → STOCK No.	DENSO	NGK → STOCK No.
T20P-U	BP6FS 3512	VUH27D	IMR9C-9H 6777	W20EP-U	BP6ES 7811	W24ESR-ZU	BR8EIX 5044
T20R-U	BR6FS 4323	VUH27ES	IMR9C-9HES 5766	W20EP-ZU	BPR6EIX 6637	W24ES-U	B8ES 2411
T22EP-U	BP7EFS 3526	VUH27Z	IMR9A-9H 6966	W20ES	B6ES 7310	W24ES-V	B8EG 3430
T22MP-U	BPM7F 1268	VW20T	BPR6EIX-LPG 2347	W20ES-L	BR6ES 4922	W24ESR-ZU	BR8EIX 5044
T22M-U	BM7F 6421	VW22	BPR7EIX 4055	W20ESR	BR6ES 4922	W24FPR	BPR8HS 3725
TR20	B6HS 4510	VX22BC	IJR7A9 7901	W20ESR-L	BR6ES 4922	W24FP-U	BP8HS 2630
TR22	B7HS 5110	VX22BZ	IJR7A9 7901	W20ESR-U	BR6ES 4922	W24FR-L	BR8HSA 5539
TR22-10	B7HS-10 2129	VXEHC24G	ILZKAR8H8S 95112	W20ES-U	B6ES 7310	W24FS	B8HS 5510
TR24	B8HS 5510	VXU22I	IKR7D 4759	W20ETR-L	BPR6EKN 1128	W24FS-GU	BR8HIX 7001
TR24-10	B8HS-10 5126	VXUHC22G	ILZKR7A 1961	W20EXR-U	BPR6EY 6427	W24FSR	BR8HS 4322
U14FSR-UB	CR4HSB 4695	W14	B4 3210	W20EXR-U11	BPR6EY-11 4228	W24FSR-U10	BR8HS-10 1134
U16FER-9	CR5EH-9 6689	W14E	B4ES 4129	W20EX-U	BP6EY 7727	W24FS-U	B8HS 5510
U16FSR-L	CR5HS 2874	W14EPR-U	BPR4ES 7222	W20FP	BP6HS 4511	W24FS-U10	B8HS-10 5126
U16FSR-U	CR5HS 2874	W14ER-U	BR4ES 1097	W20FPR	BPR6HS 7022	W24FS-ZU	BR8HIX 7001
U16FSR-UB	CR5HSB 6535	W14F	B4H 4110	W20FPR-U	BPR6HS 7022	W24S	B8S 3810
U16FS-UB	CR5HSB 6535	W14FP	BP4HS 3611	W20FP-U	BP6HS 4511	W24S-U	B8S 3810
U20EPR-U	CPR6EA-9 6899	W14FP-L	BP4HS 3611	W20FP-U10	BP6HS-10 6326	W25EB	BR8ET 4221
U20ESR-N	CR6E 6965	W14FPR	BPR4HS 7823	W20FR-L	BPR6HSA 4632	W25EBR	BR8ET 4221
U20FS	C6HSA 3228	W14FPR-L	BPR4HS 7823	W20FS	B6HS 4510	W25EDR	BR8EQ 3328
U20FS-L	C6HSA 3228	W14FPR-U	BPR4HS 7823	W20FSR	BR6HS 3922	W25EN	B8EG 3430
U20FSR-U	CR6HSA 2983	W14FPR-UL	BPR4HS 7823	W20FSR-U	BR6HS 3922	W25EPT	B8EGP 2046
U20FS-U	C6HSA 3228	W14FPR-UL10	BPR4HS-10 5024	W20FS-U	B6HS 4510	W25FN	BR8HIX 7001
U20M-U	CM-6 5812	W14FP-U	BP4HS 3611	W20M	BM6A 5921	W27AZ	BR9HIX 5687
U22EPR9	CPR7EA-9 3901	W14FP-UL	BP4HS 3611	W20MP-U	BPM6A 7021	W27EBR	BR9ET 4528
U22ES-N	C7E 5096	W14FR-U	BR4HS 3322	W20MR-U	BMR6A 7421	W27EMR-C	BR9ECM 3252
U22ESR-N	CR7E 4578	W14F-U	B4H 4110	W20M-U	BM6A 5921	W27EMR-ZU	BR9ECMIX 2707
U22ESR-NB	CR7EB 4663	W14F-U10	B4H 4110	W20M-US	BM6A 5921	W27EN	B9EG 3530
U22FS	C7HSA 4629	W14L	B4L 3112	W20S	B6S 3510	W27ES	B9ES 2611
U22FS-L	C7HSA 4629	W14LMR-US	BR4LM 4133	W20SR-U	BR6S 3522	W27ESC	B9ECS 7058
U22FSR-L	CR7HS 7223	W14LM-U	B4LM 3410	W20S-U	B6S 3510	W27ES-GU	BR9EIX 3981
U22FSR-U	CR7HSA 4549	W14LM-US	B4LM 3410	W22EB	BR7ET 4121	W27ESR	BR9ES 5722
U22FS-U	C7HSA 4629	W14MPR-U10	BPMR4A 6028	W22EBR	BR7ET 4121	W27ESR-U	BR9ES 5722
U24ES-N	C8E 7471	W14MR-U	BMR4A 5728	W22EDR	BR7EQ 5128	W27ESRV	BR9EG 3230
U24ESR-N	CR8E 1275	W14M-U	BM4A 5628	W22EP	BP7ES 2412	W27ESR-ZU	BR9EIX 3981
U24ESR-NB	CR8EB 7784	W14M-US	BM4A 5628	W22EP-GU	BPR7EIX 4055	W27ES-U	B9ES 2611
U24ESR-NZU	CR8EIX 4218	W14P	BP5S 3011	W22EPR-U	BPR7ES 2023	W27ES-V	B9EG 3530
U24ETR	CR8EK 3478	W14PR-U	BP4 2911	W22EP-U	BP7ES 2412	W27ES-ZU	BR9EIX 3981
U24FER9	CR8EH-9 5666	W14-U	B4 3210	W22EP-ZU	BPR7EIX 4055	W27FS	B9HS 5810
U24FS	C8HSA 6821	W14-US	B4 3210	W22ES	B7ES 1111	W27FS-GU	BR9HIX 5687
U24FS-C	C8HSA 6821	W16EP-GU	BPR5EIX 6597	W22ES-GU	BR7EIX 6664	W27FSR	BR9HS 4522
U24FS-L	C8HSA 6821	W16EPR-U	BPR5ES 7422	W22ESR	BR7ES 5122	W27FSR-U10	BR9HS-10 4551
U24FSR-C	CR8HSA 2086	W16EPR-U11	BPR5ES-11 4424	W22ESR-U	BR7ES 5122	W27FS-U	B9HS 5810
U24FSR-U	CR8HS 7423	W16EP-U	BP5ES 6511	W22ES-U	B7ES 1111	W27FS-U10	B9HS-10 3626
U24FS-U	C8HSA 6821	W16EP-U11	BPR5EY-11 3208	W22ES-ZU	BR7EIX 6664	W27FS-ZU	BR9HIX 5687
U27ES-N	C9E 7499	W16EP-ZU	BPR5EIX 6597	W22FP	BP7HS 5111	W29AZ	BR10EIX 6801
U27ESR-N	CR9E 6263	W16ES	B5ES 6410	W22FPR	BPR7HS 6422	W29EBR	BR10ET 7480
U27ESR-NB	CR9EB 6955	W16ES-L	BR5ES 4722	W22FPR-U	BPR7HS 6422	W29ES-GU	BR10EIX 6801
U27ESR-NZU	CR9EIX 3521	W16ESR-U	BR5ES 4722	W22FP-U	BP7HS 5111	W29ES-ZU	BR10EIX 6801
U27ETR	CR9EK 4548	W16ES-U	B5ES 6410	W22FP-U10	BP7HS-10 7829	W31AZ	BR10EIX 6801
U27FER-9	CR9EH-9 7502	W16EXR-U	BPR5EY 2828	W22FS	B7HS 5110	W31EMR-C	BR10ECS 5880
U27FER-ZU9	CR9EHIX-9 6216	W16EXR-U11	BPR5EY-11 3028	W22FS-GU	BR7HIX 7067	W31EMR-ZU	BR10ECMIX 3006
U31ESR-N	CR10E 6264	W16EXR-ZU	BPR5EIX 6597	W22FSR	BR7HS 4122	W31EN	B10EG 3630
U31ESR-NZU	CR10EIX 6482	W16EX-U	BP5EY 7327	W22FS-U	B7HS 5110	W31EPT	B10EGP 5224
U31ETR	CR10EK 2360	W16FP	BP5HS 4111	W22FS-U10	B7HS-10 2129	W31ES	BR10ES 4832
VFKH16	DILFR5A11 93759	W16FP-L	BP5HS 4111	W22FS-ZU	BR7HIX 7067	W31ES-GU	BR10EIX 6801
VFXEH20	ILKAR7C10 94940	W16FPR	BPR5HS 6222	W22M	BM7A 6521	W31ESR-U	BR10ES 4832
VFXEHC22G	DILZKAR7C11S 90137	W16FPR-U	BPR5HS 6222	W22MPR-U	BPMR7A 4626	W31ESR-ZU	BR10EIX 6801
VK16	IFR5J11 7418	W16FP-U	BP5HS 4111	W22MP-U	BPM7A 7321	W31ES-U	BR10ES 4832
VK16PR-Z11	IFR5L11 6502	W16FP-U10	BP5HS 4111	W22MP-US	BPM7A 7321	W31ES-ZU	BR10EIX 6801
VK20PR-Z11	IFR6L11 3678	W16FP-UL	BP5HS 4111	W22M-U	BM7A 6521	W31FS	B10HVX 2940
VK20T	BKR6EIX-LPG 3356	W16FS	B5HS 4210	W22M-US	BM7A 6521	W31FS-GU	BR10HIX 6692
VK22	BKR7EIX 2667	W16FSR	BR5HS 3722	W22S	B7S 3710	W31FS-ZU	BR10HIX 6692
VK22PR-Z11	IFR7L11 5114	W16FS-U	B5HS 4210	W22S-U	B7S 3710	W32EPT	B11EGP 2191
VK24PR-Z11	IFR8H11 5068	W16LS	B6L 3212	W24EMRC	BR8ECM 3035	W34ES-ZU	B11EGV 5831
VK27PR-Z11	IFR9H11 6588	W16P-U	BP5S 3011	W24EP	BP8ES 2912	W9	B2 3110
VKA20	HB6AIX-11P 5703	W16S-U	BMR6A 7421	W24EP-11	BP8ES 2912	W9EP	BP2ES 3467
VKB20	HB6BIX-11P 5705	W17ES	B6ES 7310	W24EPR-U	BPR8ES 3923	W9EXR-U	BPR2ES 2264
VKH20	ILFR6J-11K 4458	W20EPB	BP6ET 1263	W24EPR-ZU	BPR8EIX 6684	W9EX-U	BP2ES 3467
VKH20Y	ILFR6B 6481	W20EPBRS	BUR6ET 3172	W24EP-U	BP8ES 2912	W9FP	BP2HS 7926
VKH22	ILFR7H 5245	W20EP-GU	BPR6EIX 6637	W24ES	B8ES 2411	W9FP-L	BP2HS 7926
VKJ20RZ-M11	IZFR6F11 4095	W20EPR-U	BPR6ES 7822	W24ES-GU	BR8EIX 5044	W9FP-UL	BP2HS 7926
VNH27Z	IMR9B-9H 4888	W20EPR-U10	BPR6ES-11 4824	W24ESR	BR8ES 5422	W9LMR-US	BR2LM 5798
VUH24D	IMR8C-9H 3653	W20EPR-U11	BPR6ES-11 4824	W24ESR-U	BR8ES 5422	W9LM-US	B2LM 1147
VUH24ES	IMR8C-9HES 5990	W20EPR-ZU	BPR6EIX 6637	W24ESRV	BR8EG 3130	W9P	BP4 2911

DENSO	NGK → STOCK No.	
W9P-U	BP-4	2911
W9-U	B2	3110
WA20M	BM6F	6221
WA20M-U	BM6F	6221
WA22M	BM7F	6421
WA22M-U	BM7F	6421
X16EPR-U9	DPR5EA-9	2887
X16EP-U9	DPR5EA-9	2887
X16FSR-U	DR5HS	4623
X16FS-U	DR5HS	4623
X20EPR-U9	DPR6EA-9	5531
X20ES-U	D6EA	7512
X20FSR-U	DR6HS	4823
X20FS-U	D6HA	6512
X22EPR-GL	DPR7EIX-9	7803
X22EPR-U9	DPR7EA-9	5129
X22EPR-ZU9	DPR7EIX-9	7803
X22EP-U9	DPR7EA-9	5129
X22EP-ZU9	DPR7EIX-9	7803
X22ESR-U	DR7ES	3123
X22ES-U	D7EA	7912
X24EPR-GL	DPR8EIX-9	2202
X24EPR-U9	DPR8EA-9	4929
X24EPR-ZU9	DPR8EIX-9	2202
X24EP-U	DPR8EA-9	4929
X24EP-U9	DPR8EA-9	4929
X24EP-ZU9	DPR8EIX-9	2202
X24ES-GU	DR8EIX	6681
X24ESR-U	DR8ES-L	2923
X24ESR-ZU	DR8EIX	6681
X24ES-U	D8EA	2120
X24ES-ZU	DR8EIX	6681
X24FSR-U	DR8HS	5123
X24FS-U	D8HA	7112
X24GPR-U	DPR8Z	4730
X24GP-U	DPR8Z	4730
X27EPR-U9	DPR9EA-9	5329
X27EPR-ZU9	DPR9EIX-9	5545
X27EP-U9	DPR9EA-9	5329
X27ESR-U	DR8ES	5423
X27ESR-ZU	DR9EIX	4772
X27ES-U	D9EA	2420
X27GPR-U	DPR9Z	4830
XE20HR-U9	LZKAR7A	6799
XU20EPR-U	DCPR6E	3481
XU20EPR-ZU	DCPR7EIX	6046
XU20EP-U	DCPR6E	3481
XU22EPR-U	DCPR7E	3932
XU22EPR-ZU	DCPR7EIX	6046
XU22EP-U	DCP7E	2363
XU22EP-ZU	DCPR7EIX	6046
XU22HDR-9	LKR7B-9	5847
XU22PR-9	DCPR7EA-9	6651
XU24EPR-U	DCPR8E	4339
XU24EPR-ZU	DCPR8EIX	6546
XU24EP-U	DCPR8E	4339
XU24EP-ZU	DCP8EVX	6546
XU27EPR-U	DCPR9E	2641
XU27EPR-ZU	DCPR9EIX	2316
Y24FER-C	ER8EH	4011
Y27FER	ER9EH	5869
Y27FER-C	ER9EH	5869
Y31FER-C	ER10EH	2862
Z20ES-U	D6EA	7512
ZC20HPR11	ILKAR7L11	94124
ZT20EPR11	ITR6F13	4477
ZXU20PR11	IKR6G11	7980
DODGE - See CHRYSLER GROUP		
DREXEL NGK → STOCK No.		
1411740	BPR5FS	2423

DUCATI	NGK → STOCK No.	
6704038A1	MAR10A-J	4706
67040491	KR8C-G	97516
67040491A	KR8C-G	97516
67040511A	LMDR10A-JS	97718
ENKER / BOSNA	NGK → STOCK No.	
F100C	B8HS	5510
F45CP	BP4HS	3611
F50C	B5HS	4210
F55CP	BP5HS	4111
F65CP	BP6HS	4511
F75C	B6HS	4510
F80C	B7HS	5110
F85CP	BP7HS	5111
FA50	B4L	3112
FA70	B6L	3212
FE100C	B9ES	2611
FE30C	B4ES	4129
FE45CP	BP5ES	6511
FE50C	B5ES	6410
FE55CP	BP5ES	6511
FE55CPD	BP5ET	2287
FE65CP	BP6ES	7811
FE65CPD	BP6ET	1263
FE70C	B6ES	7310
FE75C	B7ES	1111
FE80C	B8ES	2411
FE85CP	BP7ES	2412
FE95CP	BP8ES	2912
FET65CP	BP5EFS	3712
FET75CP	BP6EFS	3812
FS20	B2	3110
FS30	B4	3210
FS50CP	BP5S	3011
FS70	B6S	3510
FS75C	B7S	3710
FS80	B8S	3810
FSC50C	BM6A	5921
FSC50P	BPM6A	7021
FSC70P	BPM6A	7021
FSC75CP	BPM7A	7321
FT45CP	BP5FS	3412
FT55CP	BP6FS	3512
FT85CP	BP7FS	3612
M30	AB2	3020
M60	AB6	2910
M75	AB7	3010
M80	AB8	7909
MT55CP	AP6FS	2710
MT65CP	AP7FS	2127
SFE55CP	BCPR5ES	6130
SFE65CP	BCPR6ES	2330
SFE65CPD	BCP6ET	4563
SFE85CP	BCPR7ES	3330
SFE85CPD	BCP7ET	2078
T70	C6HSA	3228
T90	C7HSA	4629
EVINRUDE	NGK → STOCK No.	
204470091	BR7ES	5122
278000237	BR7ES	5122
278000608	BR7ES	5122
278000609	BR8ES	5422
MCBR10EG	BR10EG	3830
MCBR8EG	BR8EG	3130
MCBR8HS	BR8HS	4322
MCBR9EG	BR9EG	3230
MCBR9ES	BR9ES	5722
EYQUEM	NGK → STOCK No.	
1000	B8HS	5510
1000 MOTO	B8HS	5510
1000CM	B7S	3710
1000L	B8ES	2411

EYQUEM	NGK → STOCK No.	
1000L MOTO	B8HS	5510
1000M	B8HS	5510
100M	B8HS	5510
1100	B9HS	5810
1100L	B8ES	2411
1100L MOTO	B8ES	2411
1150L	B9ES	2611
200	B4H	4110
202CT	B2LM	1147
300AM	B4L	3112
30AM	B4L	3112
400J	BR5FS	4123
406	BP6HS	4511
450JS	BPR4FS-15	2727
450L	B5ES	6410
480CS	BP5S	3011
500AM	B6L	3212
500C	B6S	3510
500CJT	BM6F	6221
500CM	B6S	3510
500CS	BP5S	3011
500CT	BM6A	5921
500J	BR6FS	4323
500JS	BPR4FS	1127
500M	B5HS	4210
502 MOTO	B4H	4110
502CT	B4LM	3410
505JS	BP5FS	3412
50AM	B6L	3212
50M	B5HS	4210
520CS	BP5S	3011
550CS	BP5S	3011
550JS	BPR5FS	2423
550LS	BP5ES	6511
550S	BP4HS	3611
580LS	BP5ES	6511
580S	BP4HS	3611
600CS	BP5S	3011
600JS	BPR6FS	2623
600L	B6ES	7310
600LS	BP6ES	7811
600S	BP5HS	4111
700	B6HS	4510
700 MOTO	B6HS	4510
700CM	B6S	3510
700CTS	BPM6A	7021
705JS	BP7FS	3612
705L	B6ES	7310
705L MOTO	B6ES	7310
705S	BP6HS	4511
707LS	BP6ES	7811
70M	B6HS	4510
750	BP6HS	4511
750L	B6ES	7310
750LJS	BP6EFS	3812
750LS	BP6ES	7811
753LJS	BP6EFS	3812
755	B6HS	4510
755 MOTO	B6HS	4510
755CJT	BM7F	6421
755CM	B6S	3510
755CT	BM7A	6521
755L	B6ES	7310
755L MOTO	B6ES	7310
755LJS	BP6EFS	3812
755LS	BP6ES	7811
755M	B6HS	4510
755S	BP6HS	4511
755LM	B6ES	7310
75M	B6HS	4510
775SX	BP6HS	4511
775X	B6HS	4510
800L	B6ES	7310

EYQUEM	NGK → STOCK No.	
800LJS	BP6EFS	3812
800LS	BP6ES	7811
800LS MOTO	BP6ES	7811
802L	B6ES	7310
803LJS	BP6EFS	3812
805L	B6ES	7310
805L MOTO	B6ES	7310
805LJS	BP7EFS	3526
805LJSP	TR7IX	96090
805LP	BR7EIX	6664
850	B7HS	5110
850 MOTO	B7HS	5110
850LS	BP7ES	2412
C32	B5HS	4210
C32LS	BP5ES	6511
C32S	BP5HS	4111
C42LJS3	BP6EFS	3812
C42S	BP6HS	4511
C52LS	BP5ES	6511
C62	B7HS	5110
C62LJS	BP6EF	4666
C62LJS	BP6EFS	3812
C62LS	BP6E	7529
C62LS	BP6ES	7811
C62LS3X	BP5ET	2287
C62S	BP7HS	5111
C72LJS	BP7EFS	3526
C72LS	BP7ES	2412
C72LS3X	BP6ET	1263
C82LJS	BP7EFS	3526
C82LS	BP7ES	2412
C92LS	BP8ES	2912
D1000	D8HA	7112
D1000 MOTO	D8HA	7112
D1000L	D9EA	2420
D1050L	D9EA	2420
D755 MOTO	D6HA	6512
D775	D6HA	6512
D800L	D7EA	7912
D800L MOTO	D7EA	7912
D900L	D8EA	2120
FC52LS	BCP5ES	7496
FC52LS	BCP5ES	7496
FC58LS	BCP6ES	4930
FC62LS	BCP6ES	4930
FC62LS2	BCP6ES	4930
FC62LS3	BCP6ET	4563
FC62LS3X	BCP6ET	4563
FC72LS	BCP7ES	5030
FC82LS	BCP7ES	5030
FC82LS1	BCP7ES	5030
FC82LS2	BCP7ES	5030
K200M	AB6	2910
K300M	AB6	2910
K500M	AB6	2910
K550JS	AP6FS	2710
K600M	AB6	2910
K750M	AB7	3010
KC62JS	AP6FS	2710
R1000	BR8HS	4322
R1000L	BR8ES	5422
R850	BR7HS	4122
RC42S	BPR6HS	7022
RC52LJS	BPR5EFS	2223
RC52LZ3EX	BUR5ET	3377
RC52LZE	ZGR5A	5839
RC58LZ3EX	BUR6ET	3172
RC62HJS6	TR5A-10	0005
RC62HJSP	PTR5A-10	5055
RC62HJSDP	PTR5A-10	5055
RC62LJS	BPR6EFS	3623
RC62LS	BPR6ES	7822
RC62LS5	BPR6ES-11	4824
RC62S	BPR7HS	6422

EYQUEM	NGK → STOCK No.	FIAT	NGK → STOCK No.	FORD	NGK → STOCK No.	FUJI	NGK → STOCK No.	
RC82LS	BPR7ES	2023	60512929	B7ES	1111	932-05410-00	B5ES	6410
RFC42LS	BKR5E	7938	60569957	PFR6B	3500	982-05486-00	B6ES	7310
RFC42LS2E	BKR5EK	7956	60597490	BCP7ES	5030			
RFC50LZ2E	BKR5EK	7956	60800325	BPR7ES	2023			
RFC52LS	BCPR5ES	6130	60806024	BP6ET	1263			
RFC52LS3	BKR6EKUB	3584	60810689	PFR6B	3500			
RFC52LS5	BKR5E-11	6953	71711638	BKR6E	6962			
RFC52LZE	ZFR5F	5165	71711639	BPR6ES	7822			
RFC52LZK	BKR5EZ	7642	71711640	BPR6ES	7822			
RFC58LS	BKR6E	6962	71711806	BPR6ES	7822			
RFC58LS2E	BKR6EK	2288	71711808	BKR6E	6962			
RFC58LS3	BCPR6ET	2197	7546519	BKR6E	6962			
RFC58LS5	BKR6E-11	2756	7554436	BPR7ES	2023			
RFC58LSP	BKR6EZ	4619	7554442	BP6ES	7811			
RFC58LZ	BKR6EY	3696	7554444	BPR6ES	7822			
RFC58LZ2	BKR6EKC	2848	7554445	BP6HS	4511			
RFC58LZ3EX	BKUR6ET	6437	7565476	BR8ES	5422			
RFC58LZDP	PFR6B	3500	7686643	BP6ET	1263			
RFC58LZE5	ZFR6F-11	4291	7760381	BPR7ES	2023			
RFC58LZK	BKR6EZ	4619	7760382	BPR6ES	7822			
RFC58LZP	PFR6B	3500	7760383	BKR6E	6962			
RFC62LS3X	BCPR6ET	2197	7760384	BCPR7ES	3330			
RFC62LS5	BCPR6ES-11	7121	7769243	BCPR6ET	2197			
RFC62LZ3X	BKUR7ET	7873	7772453	BKR6E	6962			
RFC82LS	BCPR7ES	3330	7772515	BPR7ES	2023			
RFC82LS3	BCPR7ET	2164	7910247204	BPR6EFS	3623			
RFC82LS5	BCPR7ES-11	1095	7FYSR	BPR7ES	2023			
RFN52HZ	LF5B	7113	7FYSSR	BPR7ES	2023			
RFN52HZ3A	LF5B	7113	7GBYSR4	BCPR7ET	2164			
RFN52LZ	BKR5EZ	7642	7GYSSR	BCPR7ES	3330			
RFN58HZ	LF6B	6677	9614738680	BKR6EKC	2848			
RFN58HZ5	LF6C-11	5788	9618494580	BKR5EK	7956			
RFN58LZ	BKR6EZ	4619	9618571880	BKR6EKC	2848			
RFN58LZ3A	BKR6EZ	4619	9619624580	BKR5EK	7956			
RWC52HSK	LZKAR7A	6799	9649464080	LF5B	7113			
T850	C7HSA	4629	9FYSSR	BPR6ES	7822			
XKC62JS	APR6FS	2922	9GYSSR	BKR6E	6962			
			FPT55210685	IKR9J8	93311			
FERRARI	NGK → STOCK No.	FORD	NGK → STOCK No.	FUJI	NGK → STOCK No.	HONDA	NGK → STOCK No.	
168325	PMR8A	5851	1032705	BKR5EKUP	2890	12290-59B-003	ILZKAR8H8S	95112
169483	PMR7A	4259	1077002	TR5A-10	5055	12290-59B-0030	ILZKAR8H8S	95112
192637	PMR8B	6378	1088847	TR5A-10	0005	12290-5R0-003	DILZKAR7C11S	90137
246615	SPMR8A6HGD	92264	1120170	PZFR5D-11	7968	12290-5R0-0030	DILZKAR7C11S	90137
55190788	ZKR7A-10	1691	1120820	APR6FS	2922	12290-PNE-0030	ZFR6K-11	6711
			1120830	BCPR6ES	2330	12290-PRB-A01	IFR7G-11KS	7746
			1120831	BCPR5ES	6130	12290-R1A-A01	DILZKR7B11GS	95710
			1120836	BPR6ES	7822	12290-R1A-H01	SILZKR7C11S	92932
			1202935	PLTR6A-10G	3587	12290-R1A-H011	SILZKR7C11S	92932
			1204572	PTR6F-13	7569	12290-R1A-H011-M1	SILZKR7C11S	92932
			1219309	TR5B-13	4559	12290-R41-L010-M1	DILZKR7B11GS	95710
			1233897	TR5A-10	5055	12290-R71-L01	DILZKR7B11GS	95710
			1255464	TR5B-13	4559	12290-RBO-J01	DIFR6D13	94167
			1307093	PTR6F-13	7569	12290-RBO-J010	DIFR6D13	94167
			1315691	IFR6F13	4477	12290-RBO-J11	DIFR6D13	94167
			1369704	TR6AP-13	5809	12290-RBO-J110-M1	DIFR6D13	94167
			1493001	TR5B-13	4559	12290-RB0-003	DILFR6J11	92491
			1505812	ILFR6B	6481	12290-RB1-0031	IZFR6K13	6774
			1685720	ILZTR6A8G	94769	12290-RMX-003	ILFR6J-11K	4458
			1770305	SILZNR8C7H	93593	12290-RMX-013	ILFR6J-11K	4458
			1787829	TR5B-13	4559	12290-RSH-003	IFR6G11K	1314
			1802090	ILZNR8A7G	91924	12290-RWO-003	DILFR6J11	92491
			1835546	LZNR7A1-8G	97576	31908-KTW-901	LMAR8A-9	4313
			1M50 12405 CA	PLTR6A-10G	3587	31908-MGC-003	LMAR8A-9S	6817
			1S7J 12405 DA	PTR6F-13	7569	31909-MEN-A310-M1	SILMAR9A9S	6213
			1S7J 12405 EB	PTR6F-13	7569	31909-MJP-G51	SILMAR8A9S	90992
			2M5V 12405 CB	PLTR6A-10G	3587	31911-KRN-731	R0409B-8	7791
			2U7J 12405 AA	PT5A-10	5055	31911-MBW-E11	IMR8C-9H	3653
			2W93 12405 CAA	IFR5N10	7866	31911-MEE-J01	IMR8C-9HES	5990
			2W93 12405 CAB	IFR5N10	7866	31912-KRN-731	R0409B-9	7792
			3SJA 12405 AB	IFR6F13	4477	31912-MBW-E110	IMR9C-9H	6777
			4M5G 12405 AA	TR5B-13	4559	31912-MCW-0030	IMR9B-9H	4888
			4M5G 12405 XE	TR5B-13	4559	31912-MEL-003	IMR9C-9HES	5766
			5086351	PLTR6A-10G	3587	31912-MGH-641	IMR8E-9HES	95397
						31915-ZOH-003	CMR5H	7599
						31916-KRM-841	CPR8EA-9	2306
						31916-KWB-601	CPR6EA-9S	1582
						31916-MEH-003	SIMR8A9	91064

HONDA - continued

HONDA	NGK → STOCK No.	HONDA	NGK → STOCK No.	HONDA	NGK → STOCK No.	HONDA	NGK → STOCK No.
31916-ZOH-003	CMR6H 3365	98076-54710	B4H 4110	98079-5617U	IFR6L11 3678	9807B-5617W	IZFR6K11 6994
31917-K40-F01	SILMAR8C9 90097	98076-54711	BP4HS 3611	98079-56810	B6ES 7310	98179-56841	BP6ES 7811
31917-K77-V01	MR7G-9E 90312	98076-54716	BR4HS 3322	98079-56811	BP6ES 7811		
31917-MKC-A01	CR6HSB-9 97276	98076-54717	BPR4HS 7823	98079-56817	BR6ES 4922		
31918-K44-V01	MR8C-9N 97985	98076-54746	BR4HS 3322	98079-56840	B6ES 7310	HUSQVARNA	NGK → STOCK No.
31918-MEB-671	IFR8H11 5068	98076-54747	BPR4HS 7823	98079-56841	BP6ES 7811	31909-MJP-G51	ZGR7GI-13G 96760
31922-MGH-642	IMR8E-9HES 95397	98076-54914	BPR4HS-10 5024	98079-56844	BPR6EIX 6637	3699-92672	BPMR8Y 2218
31988-GEV-761	ER8EH-N 5606	98076-54944	BPR4HS-10 5024	98079-56846	BPR6ES 7822	501 60 11-02	BPMR7A 4626
94701-00408	CR9EIA-9 6289	98076-55711	BP5HS 4111	98079-56847	BR6ES 4922	517 3919 3000	GR8DI-12 90908
98049-58716	ER8EH 4011	98076-55716	BR5HS 3722	98079-56941	BP6EY 7727	574 51 96-01	CMR6H 3365
98049-59716	ER9EH 5869	98076-55717	BPR5HS 6222	98079-56946	BPR6EY 6427	584 96 81-01	BPMR8Y 2218
98049-60716	ER10EH 2862	98076-55719	BP5HS 4111	98079-57145	BPR7ES-11 7226	8523867	MAR9A-6J 91321
98052-56471	CM-6 5812	98076-55747	BPR5HS 6222	98079-5714E	BKR7E-11 1283		
98056-17U	IFR6L11 3678	98076-56711	B6HS 4510	98079-5714G	ZFR7F-11 2975	HYSTER	NGK → STOCK No.
98056-54757	CR4HSB 4695	98076-56715	BPR6HSA 4632	98079-5714H	PFR7G-11S 7772	0028758	AB-6 2910
98056-55718	CR5HS 2874	98076-56716	BR6HS 3922	98079-5715H	PFR7G-11S 7772	0079161	AB-6 2910
98056-55777	CR5HSB 6535	98076-56717	BPR6HS 7022	98079-5715U	IFR7L11 5114	0123872	AB-6 2910
98056-56713	C6HSA 3228	98076-56719	BP6HS 4511	98079-5717U	IFR7L11 5114	0138366	AB-6 2910
98056-56716	CR6HS 7023	98076-5671G	BR6HSA 4296	98079-5717U	IFR7L11 5114	0197885	AB-6 2910
98056-56718	CR6HSA 2983	98076-56741	B6HS 4510	98079-571BV	IFR7G-11KS 7746	0281844	BPR4FS 1127
98056-57713	C7HSA 4629	98076-56747	BPR6HS 7022	98079-57614	BR7EIX 6664	0326827	BP2ES 3467
98056-57716	CR7HS 7223	98076-56917	BPR6HS-10 2623	98079-57810	B7ES 1111	0360046	BMR6A 7421
98056-57718	CR7HSA 4549	98076-56917	BPR6HS-10 2623	98079-57811	BP7ES 2412	1312459	AB-6 2910
98056-57918	CR7HSA-9 5147	98076-57710	B7HS 5110	98079-57816	BR7ES 5122	1324468	BPR4FS 1127
98056-58713	C8HSA 6821	98076-57711	BP7HS 5111	98079-57840	B7ES 1111	1332675	BPR5FS 2423
98056-58716	CR8HS 7423	98076-57716	BR7HS 4122	98079-57841	BP7ES 2412	1332676	BPR5FS 2423
98056-58718	CR8HSA 2086	98076-57717	BPR7HS 6422	98079-57846	BPR7ES 2023	1332693	AB-6 2910
98059-55916	CR5EH-9 6689	98076-57740	B7HS 5110	98079-57847	BR7ES 5122	1361837	BPR2ES 2264
98059-55918	CR7HSA 5147	98076-58710	B8HS 5510	98079-57876	BR7ES 5122	1389133	PTR5D-10 3784
98059-57916	CR7EH-9 3486	98076-58711	BP8HS 2630	98079-57877	BR7ES 5122	1451269	BPR5FS 2423
98059-57918	CR7HSA-9 5147	98076-58716	BR8HS 4322	98079-57946	BPR7EIX 4055	1467579	BPR5FS 2423
98059-58916	CR8EH-9 5666	98076-58717	BPR8HS 3725	98079-58644	BR8EIX 5044	3001582	AB-6 2910
98059-59916	CR9EH-9 7502	98076-5871G	BR8HSA 5539	98079-58646	BR8EIX 5044	3001585	AB-6 2910
98059-5991U	IMR9A-9H 6966	98076-58740	B8HS 5510	98079-58648	B8EG 3430	3001586	AB-6 2910
98059-599U	CR9EHI-9 6419	98076-58747	BPR8HS 3725	98079-58649	BR8EG 3130	3001588	BMR6A 7421
98061-58616	DPR8Z 4730	98076-59710	B9HS 5810	98079-58678	B8EG 3430	3001590	AB-6 2910
98061-59616	DPR9Z 4830	98076-59716	BR9HS 4522	98079-58679	BR8EG 3130	3002287	AB-6 2910
98066-54716	DR4HS 3326	98079-5414G	ZFR4F-11 4043	98079-58810	B8ES 2411	3002288	BP2ES 3467
98066-55716	DR5HS 4623	98079-54817	BPR4ES 7222	98079-58816	BR8ES 5422	3002289	BMR6A 7421
98066-56716	DR6HS 4823	98079-54846	BPR4ES 7222	98079-58819	BR8ECS 3972	3002290	BPR4ES 7222
98066-56717	D6HA 6512	98079-55145	BPR5ES-11 4424	98079-58840	B8ES 2411	3002347	BPR4ES 7222
98066-58716	DR8HS 5123	98079-55146	BPR5EY-11 3028	98079-58842	B8ECS 2821	3002348	AB-6 2910
98066-58717	D8HA 7112	98079-55147	BCPR5ES-11 3524	98079-58845	BR8ECM 3035	3002349	AB-6 2910
98069-38716	DR8ES-L 2923	98079-55148	BCPR5E-11 1273	98079-58846	BR8ES 5422	3002575	AB-6 2910
98069-55916	DPR5EA-9 2887	98079-5514E	BKR5E-11 6953	98079-58847	BPR8ES 3923	3002577	AB-6 2910
98069-56717	D6EA 7512	98079-5514H	PFR5G-11 2647	98079-58870	B8ES 2411	3004004	AB-6 2910
98069-56916	DPR6EA-9 5531	98079-5514P	ZFR5J-11 5584	98079-58876	BR8ES 5422	3050408	AB-6 2910
98069-57716	DR7ES 3123	98079-5515G	ZFR6F-11 4291	98079-59644	BR9EIX 3981	3051151	AB-6 2910
98069-57717	D7EA 7912	98079-5515U	IFR5L11 6502	98079-59646	BR9EIX 3981	3051322	AB-6 2910
98069-5771P	DR7EA 7839	98079-5517U	FR9BI-11 4709	98079-59648	B9EG 3530	3057352	BPR4ES 7222
98069-57911	DPR7EA-9 5129	98079-5517V	IFR5G-11K 3107	98079-59649	BR9EG 3230	326827	BP2ES 3467
98069-57912	DPR7EIX-9 7803	98079-55810	B5ES 6410	98079-59678	B9EG 3530	360046	BMR6A 7421
98069-57912	DPR7EIX-9 7803	98079-55811	BP5ES 6511	98079-59679	BR9EG 3230	388361	BPR5FS 2423
98069-57916	DPR7EA-9 5129	98079-55816	BR5ES 4722	98079-59810	B9ES 2611		
98069-5791U	IJR7A9 7901	98079-55817	BPR5ES 7422	98079-59811	B9ES 2611	HYUNDAI	NGK → STOCK No.
98069-58716	DR8ES 5423	98079-55840	B5ES 6410	98079-59816	BR9ES 5722	18 827 090 80	LKR6D-10E 96569
98069-58717	D8EA 2120	98079-55841	BP5ES 6511	98079-59819	BR9ECS 3520	18 829 110 50	ZFR5F-11 2262
98069-58912	DPR8EIX-9 2202	98079-55844	BPR5EIX 6597	98079-59842	B9ECS 7058	18 843 100 62	LKR6D-10E 96569
98069-58916	DPR8EA-9 4929	98079-55846	BPR5ES 7422	98079-59845	BR9ECM 3252	18 844 100 60	SILKR6C10E 97098
98069-59717	D9EA 2420	98079-55847	BR5ES 4722	98079-59847	BR9ES 5722	18 846 100 60	SILZKR6B10E 93815
98069-59912	DPR9EIX-9 5545	98079-55941	BP5EY 7327	98079-59870	B9ES 2611	18 854 100 80	LZKR6B-10E 1578
98069-59916	DPR9EA-9 5329	98079-55946	BPR5EY 2828	98079-59876	BR9ES 5722	18 855 100 60	LZKR6B-10E 1578
98069-5991F	DPR9EIX-9 5545	98079-56145	BPR6ES-11 4824	98079-60616	BR10EIX 6801		
98073-52710	B2 3110	98079-56146	BPR6EY-11 4228	98079-60646	BR10EIX 6801		
98073-54710	B4 3210	98079-56147	BCPR6ES-11 7121	98079-60648	B10EG 3630	ISKRA	NGK → STOCK No.
98073-54740	BM4A 5628	98079-56148	BCPR6E-11 3132	98079-60649	BR10EG 3830	F100RS	BR8HS 4322
98073-54744	BMR4A 5728	98079-56149	BCPR6EY-11 3720	98079-60676	BR10EIX 6801	F100S	B8HS 5510
98073-54776	BPMR4A 6028	98079-5614E	BKR6E-11 2756	98079-60678	B10EG 3630	F20	B4H 4110
98073-54944	BPMR4A-10 6328	98079-5614G	ZFR6F-11 4291	98079-60679	BR10EG 3830	F50	B5HS 4210
98073-56740	BM6A 5921	98079-5614H	PFR6G-11 5555	98079-60817	BR10ES 4832	F55PS	BP5HS 4111
98073-56741	BPM6A 7021	98079-5614J	BKR6E-N-11 5724	98079-60819	BR10ECS 5880	F65PRS	BPR6HS 7022
98073-56744	BMR6A 7421	98079-5614N	PZFR6F-11 3271	98079-60845	BR10ECM 4234	F65PS	BP6HS 4511
98073-56944	BPMR6A-10 1029	98079-5614P	ZFR6J-11 5585	9807B-561BW	IZFR6K-11S 5266	F70	B5HS 4210
98076-52711	BP2HS 7926	98079-5615G	ZFR6F-11 4291	9807B-561CW	IZFR6K-11S 5266	F75RS	BR6HS 3922
		98079-5615N	PZFR6F-11 3271	9807B-5615W	IZFR6K11 6994	F75S	B6HS 4510
						F805RS	BR7HS 4122

ISKRA	NGK → STOCK No.	
F80S	B7HS	5110
F85PS	BP7HS	5111
F95PS	BP7HS	5111
FE100RS	BR9ES	5722
FE100S	B9ES	2611
FE145P	BP9ES	7526
FE155P	BPR8EIX	6684
FE45P	BP5E	4669
FE50	B5ES	6410
FE55LRS	ZGR5A	5839
FE55LTXS	BUR5ET	3377
FE55LXS	ZGR5A	5839
FE55PRS	BPR5ES	7422
FE55PS	BP5ES	6511
FE55PTS	BP5ET	2287
FE65LTXS	BUR6ET	3172
FE65PP2	BPR6EIX	6637
FE65PRP2	BPR6ES	7822
FE65PRS	BPR6ES	7822
FE65PS	BP6ES	7811
FE65PTS	BP6ET	1263
FE75RS	BR7ES	5122
FE75S	B7ES	1111
FE80RS	BR8ES	5422
FE80S	B8ES	2411
FE85PRS	BPR7ES	2023
FE85PS	BP7ES	2412
FET55PRS	BPR5EFS	2223
FET55PS	BP5EFS	3712
FET65PRS	BPR6EFS	3623
FET65PS	BP6EFS	3812
FET75PS	BP7EFS	3526
FS50KR	BR2LM	5798
FS70	B6S	3510
FS70C	BPM6A	7021
FS75	B7S	3710
FS75C	BPM7A	7321
FT65PS	BP6FS	3512
FUT55PRP-13	PTR5A-10	5055
M60	AB6	2910
M75	AB7	3010
M80	AB8	7909
MT65PRS	APR6FS	2922
MT65PS	AP6FS	2710
SFE55LRS	ZFR5F	5165
SFE55LXS	ZFR5F	5165
SFE55PRS	BCPR5ES	6130
SFE55PRS	BKR5E	7938
SFE55PS	BCP5ES	7496
SFE65LDRS	BKR5EK	7956
SFE65LRS	ZFR6A-11	1041
SFE65LTXS	BKUR6ET	6437
SFE65LXS	ZFR6A-11	1041
SFE65PDRS	BKR6EKC	2848
SFE65PRS	BKR6E	6962
SFE65PRS	BKR6ES	3783
SFE65PS	BCP6ES	4930
SFE65PTRS	BCPR6ET	2197
SFE65PTS	BCP6ET	4563
SFE85LDRS	BKR6EK	2288
SFE85LTRS	BKUR7ET	7873
SFE85PRS	BKR7E	6097
SFE85PRS	BCPR7ES	3330
SFE85PS	BCP7ES	5030
SFE85PTRS	BCPR7ET	2164
SFE85PTS	BCP7ET	2078
T90	C7HSA	4629
TWE85PRS	DCPR8E	4179
TWE85PS	DCP7E	2363
ISOLATOR	NGK → STOCK No.	
6B	BP6HS	4511
7A	B6HS	4510
7B	BP6HS	4511

ISOLATOR	NGK → STOCK No.	
7D	BP6ES	7811
A5D	BP7EFS	3526
A7D	BP6EFS	3812
FM14-145/2	BP5ES	6511
FM14-175/2	BP6ES	7811
FM14-200/2	BP6ES	7811
FM14-225/2	BP7ES	2412
M14-145	B5HS	4210
M14-175	B6HS	4510
M14-175/2	B6ES	7310
M14-225	B7HS	5110
M14-240	B8HS	5510
M14-260	B9HS	5810
M14-95	B4H	4110
M18-225	AB7	3010
M18-240	AB7	3010
PM14-225	BP7HS	5111
U7D	BCP6ES	4930
U8D	BCP5ES	7496
ZM14-260	B8HS	5510
ISUZU	NGK → STOCK No.	
5-81380001-0	BPR5ES	7422
5-81380003-0	BPR5EIX	6597
5-81380004-0	BPR6EIX	6637
5-81380012-0	BP5EY	7327
5-81380013-0	BP6EY	7727
8-94120560-0	BPR5ES-11	4424
8-94217232-0	BPR6ES-11	4824
8-94219943-0	BPR6ES	7822
8-94328373-0	BKR7E-11	1283
8-97012928-0	BKR6E	6962
9-82513103-0	BP6ES	7811
9-82513105-0	B6ES	7310
9-82513106-0	BP5ES	6511
9-82513107-0	B5ES	6410
9-82513113-0	B7ES	1111
ITALJET	NGK → STOCK No.	
94004	BR7HS	4122
94015	DR8EA	7162
94025	BR8HS	4322
94029	BR9ES	5722
94032	CR7E	4578
JAGUAR	NGK → STOCK No.	
02AJ812988	SILZKAR7E8S	93476
2W93 12405 CAA	IFR5N10	7866
96JV12405 EAA	PPR5G-11E	3000
96JV12405 FAA	PPR5G-13E	2761
96JV12405 HAA	PPR5G-13E	2761
96JV12405 HBA	PPR6G-13E	2341
AB3850DA	BR6EF	3177
AJ812146	ILKAR7C10	94940
AJ812988	SILZKAR7E8S	93476
AJ813092	ILTR6G8G	96621
AJ84575	IFR5N10	7866
C2A1535	IFR5N10	7866
C2P23089	ILKAR7C10	94940
C2S46895	TR6AP-13E	4968
C2Z28434	SILZKAR7E8S	93476
CA 3850 DA2	PFR6G-13E	2341
CA 3850 FA1	PPR5G-13E	2761
CA 3850 HA2	PFR6G-13E	2341
EAC8344	B8ES	2411
EAC8554	BR7EFS	1094
EBC4021	BR7EF	3346
EBC8523	B7ES	1111
JC2S 46895	TR6AP-13E	4968
NCA 3850 DA2	PFR6G-13E	2341
NCA 3850 FA1	PPR5G-13E	2761
NCA 3850 HA2	PFR6G-13E	2341
XR819660	TR6AP-13E	4968
XR842795	TR6AP-13E	4968

JAPCAR	NGK → STOCK No.	
123762	BP5ES	6511
123770	BP6ES	7811
123778	BPR5ES	7422
123789	BPR6ES	7822
123801	BPR7ES	2023
123825	BPR5ES-11	4424
123834	BPR6ES-11	4824
123887	BPR5ES	7422
123899	BPR6ES	7822
123908	BPR7ES	2023
123932	BPR5ES-11	4424
123940	BPR6ES-11	4824
123993	BPR7ES-11	7226
123996	BR7ES	5122
124040	BPR7ES-11	7226
124144	BPR6ES-11	4824
166573	BPR6ES	7822
167605	PFR6J-11	2743
170006	BPR6ES-11	4824
172988	BPR5ES	7422
173939	BKR6E-11	2756
177391	BKR6E-11	2756
207417	PFR6J-11	2743
239214	PFR5J-11	4642
277200	BKR5E-11	6953
277201	BKR5E-11	6953
279427	PFR5J-11	4045
JEEP - See CHRYSLER GROUP		
JENN FENG	NGK → STOCK No.	
9111-310002	BPMR6F	1270
9295-320001	BMR6F	2144
9295-310002	BPMR6F	1270
9295-310502	CMR7H	3066
9295-331501	BPMR7A	4626
JG - See CHINESE BRANDS		
JIGUANG - See CHINESE BRANDS		
JOHNSON	NGK → STOCK No.	
204470091	BR7ES	5122
278000237	BR7ES	5122
278000608	BR7ES	5122
278000609	BR8ES	5422
MCBR10EG	BR10EG	3830
MCBR8EG	BR8EG	3130
MCBR8HS	BR8HS	4322
MCBR9EG	BR9EG	3230
MCBR9ES	BR9ES	5722
JONSERAD	NGK → STOCK No.	
574 51 96-01	CMR6H	3365
JUNGHEINRICH	NGK → STOCK No.	
14148410	BPR4FS	1127
K & N	NGK → STOCK No.	
XP422	PFR6G-11	5555
KAWASAKI	NGK → STOCK No.	
(E)92070-1063	BR9EG	3230
(E)92070-1064	BR8EG	3130
(E)92070-1165	DR7EA	7839
(E)92070-1173	BR10ES	4832
(E)92070-2077	BPR5ES	7422
92070-0010	R6918B-9	2954
92070-0014	CR9EIA-9	6289
92070-0016	BR9ECMIX	2707
92070-0020	CR8EB-9	6607
92070-0045	MR8CI-8	96973
92070-0047	SILMAR9B9	95399
92070-0716	LMAR9G	97476

KAWASAKI	NGK → STOCK No.	
92070-0720	SILMAR9E9	95123
92070-1063	BR9EG	3230
92070-1064	BR8EG	3130
92070-1142	C9E	7499
92070-1146	D6EA	7512
92070-1153	CR6HSA	2983
92070-1165	DR7EA	7839
92070-1173	BR10ES	4832
92070-1231	BR8EIX	5044
92070-1241	R6252K-105	2741
92070-1264	CR9EK	4548
92070-1265	CR8EK	3478
92070-1266	CR9E	6263
92070-2052	BP4HS	3611
92070-2061	BPR4HS	7823
92070-2070	BR4HS	3322
92070-2108	BPMR6A	6726
92070-2110	BPR2ES	2264
92070-3707	PMR9B	4717
92070-7004	BPR4ES	7222
E92070-0001	B7HS	5110
E92070-0020	CR8EB-9	6607
E92070-014	B6ES	7310
E92070-036	B9HS	5810
E92070-037	B8ES	2411
E92070-054	B9ES	2611
E92070-1002	B7ES	1111
E92070-0014	CR9EIA-9	6289
E92070-1014	BP8ES	2912
E92070-1019	DR8ES	5423
E92070-1022	BR8ES	5422
E92070-1024	BP6ES	7811
E92070-1025	BPR6ES	7822
E92070-1026	BP7ES	2412
E92070-1027	BPR7ES	2023
E92070-1034	D9EA	2420
E92070-1044	BPR8ES	3923
E92070-1053	BR9ES	5722
E92070-1057	B8EG	3430
E92070-1058	B9EG	3530
E92070-1063	BR9EG	3230
E92070-1064	BR8EG	3130
E92070-1065	DPR8EA-9	4929
E92070-1068	DPR9EA-9	5329
E92070-1109	BR9ES	5722
E92070-1113	DR7ES	3123
E92070-1114	C6HSA	3228
E92070-1116	DR8ES-L	2923
E92070-1125	DPR7EA-9	5129
E92070-1132	B10EG	3630
E92070-1133	BR10EG	3830
E92070-1138	DPR6EA-9	5531
E92070-1143	CR9E	6263
E92070-1145	CR9EK	4548
E92070-1153	CR6HSA	2983
E92070-1154	CR7HSA	4549
E92070-1155	CR8HSA	2086
E92070-1157	BR9ES	5722
E92070-1158	CR8EK	3478
E92070-1169	CR8E	1275
E92070-1173	BR10ES	4832
E92070-1178	BP5ES	6511
E92070-1186	BR10EIX	6801
E92070-1189	DR9EA	3437
E92070-1199	DR8EA	7162
E92070-1209	CR7E	4578
E92070-1212	BR9EIX	3981
E92070-1215	BR8EIX	5044
E92070-1250	DPR5EA-9	2887
E92070-1254	CR9EKPA	7785
E92070-1266	CR9E	6263
E92070-2072	BMR4A	5728
E92070-2077	BPR5ES	7422
E92070-2100	BMR2A	7677

KIA	NGK → STOCK No.	
18 829 110 50	ZFR5F-11	2262
18 843 100 62	LKR6D-10E	96569
18 844 100 60	SILKR6C10E	97098
18 846 100 60	SILZKR6B10E	93815
18 854 100 80	LZKR6B-10E	1578
18 855 100 60	LZKR6B-10E	1578
OK55818110	PFR6N-11	3546
KLK	NGK → STOCK No.	
F100	B8HS	5510
F20	B4H	4110
F220	B9HS	5810
F50	B5HS	4210
F55P	BP5HS	4111
F65P	BP6HS	4511
F70	B5HS	4210
F75	B6HS	4510
F80	B7HS	5110
F85P	BP6HS	4511
F95P	BP7HS	5111
FA50	B4L	3112
FA70	B6L	3212
FE100	B8ES	2411
FE125P	BP6ES	7811
FE135P	BP7ES	2412
FE145P	BP8ES	2912
FE155P	BP8ES	2912
FE220	B9ES	2611
FE30	B4ES	4129
FE45P	BP5ES	6511
FE50	B5ES	6410
FE55P	BP5ES	6511
FE65P	BP6ES	7811
FE70	B5ES	6410
FE75	B6ES	7310
FE80	B7ES	1111
FE85P	BP6ES	7811
FE95P	BP7ES	2412
FS100	B8S	3810
FS20	B2	3110
FS30	B4	3210
FS35P	BP4	2911
FS45P	BP5S	3011
FS50	B6S	3510
FS70	B6S	3510
FS75	B7S	3710
FS75H	B7S	3710
FT55P	BP5FS	3412
FT65P	BP5FS	3412
FT85P	BP6FS	3512
FT95P	BP7FS	3612
GT4S	BP5S	3011
GT5	BP5HS	4111
GT5L	BP5ES	6511
GT6	BP6HS	4511
GT6L	BP6ES	7811
GT6T	AP6FS	2710
GT7	BP7HS	5111
GT7L	BP7ES	2412
GT8L	BP8ES	2912
L777	B6HS	4510
M30	AB2	3020
M50	AB6	2910
M60	AB6	2910
M75	AB7	3010
M80	AB8	7909
MT75P	AP6FS	2710
MT85P	AP6FS	2710
T30	C6HSA	3228
T70	C7HSA	4629
T90	C8HSA	6821
TENL100	C8HSA	6821
TENL30	C7HSA	4629
TFS20	B2	3110

KLK	NGK → STOCK No.	
TFS30	B4	3210
TF550	B6S	3510
TW100	D6HA	6512
TW220	D6HA	6512
TW240	D8HA	7112
TW270	D6HA	6512
TW275	D6HA	6512
TW280	D8HA	7112
TWE270	D8EA	2120
TWE275	D9EA	2420
KOHLER	NGK → STOCK No.	
12 132 02	BCPR5ES	6130
12 132 02S	BCPR5ES	6130
14 132 11	DCPR7E	3932
14 132 11S	DCPR7E	3932
62 132 04S	BCPR6ES	2330
KOMATSU	NGK → STOCK No.	
22401-58001	B6ES	7310
22401-FU412	BCPR5E-11	1273
22401-M7714	B6ES	7310
22401-M7716	B6ES	7310
22401-V1414	BPR4ES	7222
22401-W8914	BP2ES	3467
37Z-02-SP02E	BP2ES	3467
37Z-02-SP04A	B6ES	7310
37Z-02-SP05A	B6ES	7310
HE0052048-00	BMR6A	7421
HE0110256-00	BMR6A	7421
HE0110526-00	BMR6A	7421
HE40-2502314	BMR6A	7421
HE52892	BMR6A	7421
TJ-90098-09125	BP2ES	3467
TJ-90919-01055	BP2ES	3467
TJ-90919-01950-71	BP2ES	3467
KTM	NGK → STOCK No.	
452390-93000	LR8B	6208
590390-93100	DCPR8E	4179
515390-93000	BR9ECMIX	2707
517391-93000	GR8DI-12	90908
554391-93000	ZGR7GI-13G	96760
604390-93000	LKAR9BI-10	95371
604390-94000	LMAR7DI-10	96956
610390-93000	DCPR8E	4339
611390-93000	KR8DI	4742
612390-93200	LKAR9BI9	6205
750390-93000	LKAR8AI-9	6706
780390-93000	LKAR8A-9	4786
797390-93000	LZMAR8BI-10	95680
901390-93000	LKAR8A-9	4786
902390-93000	LKAR8A-9	4786
KUBOTA	NGK → STOCK No.	
07909-2225-0	BM6A	5921
07909-2226-0	BM7A	6521
10202-6771-6	AB6	2910
10261-6771-6	G2Z	3320
12268-6771-1	BP2ES	3467
12366-6771-6	BR4HS	3322
12392-6771-1	BP5ES	6511
12647-6771-1	BPR6HS	7022
12681-6774-1	BR5ES	4722
12691-6771-1	BCP4ES-11	1086
12863-6771-1	BP5ES	6511
12866-6771-1	BP5ES	6511
12992-6771-1	BPR5ES	7422
13078-6771-6	BP6ES	7811
13157-6771-2	BM4A	5628
13211-6771-6	B4	3210
13281-6771-6	B4H	4110
13301-6771-6	AB2	3020
13373-6774-1	BMR4A	5728

KUBOTA	NGK → STOCK No.	
13374-6774-1	BPR4HS	7823
13375-6774-0	BPR4HS	7823
13375-6774-1	BPR4HS-10	5024
13401-6771-6	B6S	3510
13412-6771-6	B7S	3710
13451-6771-6	B6HS	4510
13581-6771-6	B7HS	5110
13582-6771-1	B6HS	4510
13641-6771-1	B4H	4110
13901-6771-6	BP6HS	4511
13979-6771-1	BP4HS	3611
LAND ROVER	NGK → STOCK No.	
LR005253	IFR5N10	7866
LR005483	ILFR6B	6481
LR019484	ILKAR7C10	94940
LR021006	BKR6EQUUP	3199
LR025605	ILTR6G8G	96621
LR032080	ILKAR7C10	94940
LR050998	SILZKAR7E8S	93476
RTC3812	BP6ES	7811
LD - See CHINESE BRANDS		
LEXUS - See TOYOTA		
LG - See CHINESE BRANDS		
LIXIN - See CHINESE BRANDS		
LODGE	NGK → STOCK No.	
15HLNY	BP6ES	7811
2H	B7HS	5110
2H12	D8HA	7112
2HA	B6S	3510
2HL	B7ES	1111
2HL10	C7HSA	4629
2HLD	BCP6ES	4930
2HL-E	B7ES	1111
2HLN	B7ES	1111
2HLNY	BP7ES	2412
2HN	B7HS	5110
2HNY	BP7HS	5111
2H-TNY	AP7FS	2127
2HTY	BP6FS	3512
2HV	AB8	7909
2XL	BP6ES	7811
25HLD	BCP6ET	4563
25HLNY	BP7ES	2412
25XL	BP6ES	7811
3HAN	B8S	3810
3HLN	B8ES	2411
3HLNY	BP7ES	2412
3HN	B8HS	5510
3HNY	BP8ES	2912
4HLNY	BP8ES	2912
5HLNY	BP8ES	2912
B14	B4H	4110
BAN	B4	3210
BANY	BP5S	3011
BBANY	BP4	2911
BBL	AB6	2910
BBNY	BP4HS	3611
BLN	B4ES	4129
BLNY	BP5ES	6511
BLTY	BPR5EFS	2223
BN	B4H	4110
B-TY	BP5FS	3412
BV	AB2	3020
C3	AB6	2910
CAN	B6S	3510
CANB	BPM6A	7021
CANC	BM6A	5921
CB14	B5ES	6410

LODGE	NGK → STOCK No.	
CL14	B5ES	6410
CLN	B6ES	7310
CLN14P	B5ES	6410
CLNH	B5ES	6410
CLNY	BP5ES	6511
CN	B5HS	4210
CNY	BP5HS	4111
CSN	B4L	3112
CTY	BP5FS	3412
CV	AB6	2910
H	B6HS	4510
H12	D6HA	6512
H18	AB7	3010
HA	B7S	3710
HAN	B7S	3710
HAN/M	B7S	3710
HB12	D6HA	6512
HBAN	B6S	3510
HBL12	D8EA	2120
HBLN	B5ES	6410
HBN	B5HS	4210
HBSN	B6L	3212
HBTNY	AP6FS	2710
HBTY	BP5FS	3412
HBV	AB6	2910
HL	B6ES	7310
HL12	D9EA	2420
HL14	B6ES	7310
HL-E	B6ES	7310
HLN	B6ES	7310
HLNP	B6ES	7310
HLNY	BP6ES	7811
HN	B6HS	4510
HNY	BP6HS	4511
HT14	BP5FS	3412
HT18	AP6FS	2710
HTNY	AP6FS	2710
H-TY	BP6FS	3512
HV	AB7	3010
MARCHAL/VALEO	NGK → STOCK No.	
17C	AB7	3010
19C	AB7	3010
19E	AB7	3010
19L	AB7	3010
2/13	AB8	7909
2/32	B8HS	5510
2/32H	B8ES	2411
2/33	B8HS	5510
2/33H	B7ES	1111
20C	AB6	2910
20E	AB6	2910
20L	AB6	2910
21C	AB6	2910
21E	AB6	2910
21L	AB6	2910
22L	AB2	3020
22LM	AB2	3020
34/5HS	BP6ES	7811
34C	B7S	3710
34CM	B7S	3710
34HS	B7ES	1111
34HSM	B7ES	1111
34S	B7HS	5110
35	B6HS	4510
35/1	BP6HS	4511
35/1B	BP6HS	4511
35/1D	BP6HS	4511
35/36D	B6HS	4510
35/36P	B6HS	4510
35/36R	B6HS	4510
35B	B6HS	4510
35C	B6S	3510
35CM	B6S	3510

MARCHAL/VALEO	NGK → STOCK No.	
35HA	BP6ES	7811
35HS	B6ES	7310
35M	B6HS	4510
35P	B6HS	4510
36	B5HS	4210
36B	B5HS	4210
36C	B4	3210
36CM	B4	3210
36D	B5HS	4210
36HS	B5ES	6410
36M	B5HS	4210
36P	B5HS	4210
37S	B5HS	4210
4N	B7HS	5110
5H	B7ES	1111
5N	BP6HS	4511
5N CYCLO	BP6HS	4511
64H	BP7ES	2412
67HP	BR8EIX	5044
6H	BP7ES	2412
6N	BP5HS	4111
70H	BP6ES	7811
76H	BP5ES	6511
7H	BP6ES	7811
84H	BP5ES	6511
88N	B5HS	4210
8H	BP6ES	7811
9H	BP5ES	6511
C64H	BP6EFS	3812
C68H	BP6EFS	3812
C7H	BP6EFS	3812
F70H	BCP7ES	5030
F74H	BCP6ES	4930
F80H	BCP7ES	5030
GT34	BP7HS	5111
GT34/2H	BP6ES	7811
GT34/5	BP6HS	4511
GT34/5D	BP6HS	4511
GT34/5H	BP6ES	7811
GT34/5HA	BP6ES	7811
GT34/5HD	BP6ES	7811
GT34D	BP7HS	5111
GT34H	BP7ES	2412
GT34HD	BP6ES	7811
GT35	BP5HS	4111
GT35D	BP5HS	4111
GT35H	BP5ES	6511
GT35HD	BP5ES	6511
H32RG	B9EG	3530
H33RG	B8EG	3430
H34F	B8ES	2411
HA32/2	B8ES	2411
HA32RS	B9EG	3530
HF34	B7ES	1111
HF34F	B8ES	2411
RR31HS	B10EG	3630
RR32HS	BR9EIX	3981
RR33HSS	BR8EIX	5044
SCGT34/5H	BP6EFS	3812
SCGT35H	BP6EFS	3812
V36A	B5HS	4210
V6N SOLEX	B5HS	4210

MARELLI	NGK → STOCK No.	
7LCR	BKR6E	6962
7LPR	BKR6E	6962
8LCR	BCPR7ES	3330
8LDCR	PTR5A-10	5055
8LPR	BCPR7ES	3330
AW56C	BM7A	6521
AW5C	BM6A	5921
CM1N	AB2	3020
CM2N	AB2	3020
CM3N	AB6	2910

MARELLI	NGK → STOCK No.	
CM4N	AB6	2910
CM5N	AB6	2910
CM6N	AB7	3010
CU7N	C7HSA	4629
CW101L	B85EGV	7498
CW10L	B8EG	3430
CW112L	B9EG	3530
CW11L	B9EG	3530
CW12L	B9EG	3530
CW12NV	BUH	2422
CW13L	B10EG	3630
CW14L	B10EG	3630
CW225A	B6HS	4510
CW250A	B7HS	5110
CW25N	B4H	4110
CW260N	B7HS	5110
CW2C	B2	3110
CW2CJ	B2	3110
CW2L	B4ES	4129
CW2N	B4H	4110
CW3C	B4	3210
CW3CJ	B4	3210
CW3CP	BP4	2911
CW3L	B4ES	4129
CW3N	B4H	4110
CW4A	B5ES	6410
CW4C	B4	3210
CW4CJ	B4	3210
CW4CP	BP4	2911
CW4L	B4ES	4129
CW4N	B4H	4110
CW4NJ	B4H	4110
CW55N	B5HS	4210
CW5C	B4	3210
CW5CP	BP5S	3011
CW5L	B5ES	6410
CW5LP	BP5ES	6511
CW5LS	B5ES	6410
CW5LSZ	B5ES	6410
CW5N	B5HS	4210
CW5NJ	B5HS	4210
CW5NP	BP5HS	4111
CW5NR	BR5HS	3722
CW5NS	B5HS	4210
CW5NSZ	B5HS	4210
CW67L	B6ES	7310
CW67LP	BP6ES	7811
CW67N	BP6HS	4511
CW67NJ	B6HS	4510
CW67NR	BR6HS	3922
CW67P	BP5ES	6511
CW6C	B6S	3510
CW6CE	BM6A	5921
CW6CJ	B6S	3510
CW6L	B5ES	6410
CW6LJ	B5ES	6410
CW6LP	BP5ES	6511
CW6LR	BR5ES	4722
CW6LS	B5ES	6410
CW6LSZ	B5ES	6410
CW6N	B6HS	4510
CW6NE	BM6A	5921
CW6NJ	B6HS	4510
CW6NP	BP6HS	4511
CW6NPR	BPR6HS	7022
CW6NR	BR6HS	3922
CW75LP	BP6ES	7811
CW78L	B6ES	7310
CW78LP	BP6ES	7811
CW78LPR	BPR6ES	7822
CW78LPS	BP6ES	7811
CW7C	B6S	3510
CW7L	B6ES	7310

MARELLI	NGK → STOCK No.	
CW7LCR	BKR6E	6962
CW7LJ	B6ES	7310
CW7LP	BP6ES	7811
CW7LPH	BP6ES	7811
CW7LPR	BPR6ES	7822
CW7LR	BR6ES	4922
CW7N	B6HS	4510
CW7NJ	B6HS	4510
CW7NP	BP6HS	4511
CW7NPR	BPR6HS	7022
CW7NR	BR6HS	3922
CW89LP	BP7ES	2412
CW8CJ	B7S	3710
CW8L	B7ES	1111
CW8LCR	BCPR7ES	3330
CW8LJ	B7ES	1111
CW8LP	BP7ES	2412
CW8LPR	BPR7ES	2023
CW8LPS	BP7ES	2412
CW8N	B7HS	5110
CW8NP	BP7HS	5111
CW8NR	BR7HS	4122
CW9L	B8ES	2411
CW9LJ	B8ES	2411
CW9LP	BP8ES	2912
CW9N	B8HS	5510
CWC12NJ	B8HS	5510
CWC67NJ	B6HS	4510
CWC6NJ	B6HS	4510
CWC7NJ	B6HS	4510
CWC9NJ	B7HS	5110
CWF11L	BR8EIX	5044
CWP10L	BR9EIX	3981
CWP10N	BR9HIX	5687
CWP11L	BR10EIX	6801
CWP8L	BR7EIX	6664
CWP8N	BR7HIX	7067
CWP9L	BR8EIX	5044
CWP9N	BR8HIX	7001
CX6N	D6HA	6512
CX8L	D8EA	2120
CX8N	D8HA	7112
DW4CJR	BR6S	3522
F6NC	BP5HS	4111
F6NCR	BPR5HS	6222
F7LC	BP6ES	7811
F7LCR	BPR6ES	7822
F7NC	BP6HS	4511
F7NCR	BPR6HS	7022
F8LC	BP7ES	2412
F8LCR	BPR7ES	2023
FC6N	B5HS	4210
FC7N	B6HS	4510
FC9L	BP8ES	2912
SW5C	BM6F	6221
T7LC	BP6EFS	3812
T7LCR	BPR6EFS	3623
T8LC	BP7EFS	3526
TM4NP	AP6FS	2710
TW4LP	BP5EFS	3712
TW5NP	BP5FS	3412
TW6NP	BP6FS	3512
TW78LP	BP6EFS	3812
TW78LPR	BPR6EFS	3623
TW78NPR	BPR6FS	2623
TW7LP	BP6EFS	3812
TW7LPR	BPR6EFS	3623
TW7NP	BP6FS	3512

MASERATI	NGK → STOCK No.	
239242	PMR8C-H	96361
310235	SILKAR8C6DS	96372

MAZDA	NGK → STOCK No.	
0190 18 110	B6HS	4510
0259 18 110	BP6ES	7811
0370 18 110	BPR6EIX	6637
0371 18 110	BPR5EIX	6597
0376 18 110	BPR7EIX	4055
0419 18 110	B7ES	1111
0420 18 110	B8ES	2411
0512 18 110	B6ES	7310
0660 18 110	BP5ES	6511
0745 18 110	BP7ES	2412
1002 77 550	BP5EY	7327
1003 77 550	BP6EY	7727
1482 18 600A	BR8EQ	3328
1690 18 110	BPR6ES	7822
1UX5-18-110	HB6AIX-11P	5703
1UXQ-18-110	HB6BIX-11P	5705
3648 18 600	BR7ET	4121
3649 18 600	BR8ET	4221
4885 18 110	BPR2ES	2264
4894 18 110	BP2ES	3467
8182 18 600	BR7EQ	5128
8344 18 600	BR9ET	4528
8914 18 110	BPR5ES	7422
A501 18 110	BP6E	7529
AY02 18 110	DCP7E	2363
AZ08 18 110	BPR5E	7075
B601 18 110	BPR5ES-11	4424
B695 18 110	BCPR6E	1269
B6B3 18 110	BCPR5E-11	1273
BP01 18 110	BKR5E-11	6953
BP03 18 110	BKR6E-11	2756
BP05 18 110	BKR7E-11	1283
BP13 18 110	BKR5E-11	6953
BP47 18 110	BKR5E	7938
BP49 18 110	BKR6E	6962
BP51 18 110	BKR7E	6097
F201 18 110	ZFR6A-11	1041
F203 18 110	ZFR5A-11	5084
F210 18 110	BCPR5E	1145
F220 18 110	BCPR6E-11	3132
F285 18 110	ZFR6F-11	4291
F287 18 110	ZFR5F-11	2262
F289 18 110	ZFR7F-11	2975
FE79 18 110	BPR6ES-11	4824
JE03 18 110	BCPR7E	1272
KJ11 18 110	PZFR6F	7550
L303 18 110	TR5AI-13	90813
L3K9 18 110	ILTR6A-8G	3787
L3K9 18 110A	ILTR6A-8G	3787
L3Y1 18 110	ILTR6A-13G	3789
L3Y2 18 110	ILTR5A-13G	3811
L3Y3 18 110	ILTR6A-8G	3787
L3YD 18 110	SILTR6A7G	95369
L813 18 110	ITR6F13	4477
L845 18 110	TR5AI-13	90813
N322 18 110	BR10ET	7480
N342 18 110	BUR9EQ	5483
N3A1 18 110	BUR9EQP	5255
N3A3 18 110	BUR8EQP	4582
N3Y4 18 110A	RE9B-T	2809
N3Z2 18 110A	RE7C-L	6700
N3Z4 18 110A	RE7C-L	6700
N3Z5 18 110	RE8C-L	5745
PE 5R 18 110	ILKAR7L11	94124
PE 5S 18 110	ILKAR7L11	94124
ZM0118110	IzFR5G	5887

MCC - See SMART		
McCULLOCH	NGK → STOCK No.	
9111-310002-CH	BPMR6F	1270
SPO002	BPMR7A	4626

MITSUBISHI	NGK → STOCK No.	MOTORCRAFT	NGK → STOCK No.	MOTORCRAFT	NGK → STOCK No.	MOTORCRAFT	NGK → STOCK No.
Z 2152 947	BPR7ES 2023	AG1C	B8ES 2411	AGPS22P1	BKR6EIX 6418	ARF32M	BPR6FS 2623
Z 2152 948	BPR7ES-11 7226	AG1X	B8ES 2411	AGPS22PP1	PPR6B 3500	ARF4	BR5FS 4123
Z 2152 949	BCPR7ES-11 1095	AG12	BP7ES 2412	AGPS32C	BCPR5ES 6130	ARF42	BPR5FS 2423
Z 2152 950	BCPR6ES-11 7121	AG12C	BP7ES 2412	AGPS44F	PZFR5D-11 7968	ARF42-6	BPR5FS-15 3124
MONTESA NGK → STOCK No.		AG12CU	BP7ES 2412	AGPS44F11J	PZFR5D-11 7968	ARF42CU	BPR5FS 2423
98059-56916-00	CR6EH-9 2688	AG2	B7ES 1111	AGR1X	BR8ES 5422	ARF52	BPR4FS 1127
MOPAR - See CHRYSLER GROUP		AG2C	B7ES 1111	AGR12C	BPR7ES 2023	ARF52-6	BPR4FS-15 2727
MOTO-GUZZI NGK → STOCK No.		AG2CU	B7ES 1111	AGR16C	BR8ET 4221	ARF6	BR5FS 4123
887016	LMAR8F-9 90894	AG2X	B7ES 1111	AGR2C	BR7ES 5122	ARF62	BPR4FS 1127
MOTORCRAFT NGK → STOCK No.		AG203	B11EGP 2191	AGR21	BR6ES 4922	ARF62-6	BPR4FS-15 2727
A11	B2 3110	AG22	BP6ES 7811	AGR22	BPR6ES 7822	ARF8	BR5FS 4123
A11NX	BM4A 5628	AG22C	BP6ES 7811	AGR22C	BPR6ES 7822	ASF32	BPR6FS 2623
A11U	B2 3110	AG22CU	BP6ES 7811	AGR22CU	BPR6ES 7822	ASF32C	BPR6FS 2623
A11X	B2 3110	AG23	B7ECS 2528	AGR3X	BR6ES 4922	ASF32M	BPR6FS 2623
A1CU	B8S 3810	AG252	BP6ES 7811	AGR31	BR6ES 4922	ASF42	BPR5FS-11 2924
A21X	B8S 3810	AG252C	BP6ES 7811	AGR32	BPR6ES 7822	ASF42-6C	BPR5FS-15 3124
A22NX	BPM7A 7321	AG3	B6ES 7310	AGR32C	BPR6ES 7822	ASF42C	BPR5FS-11 2924
A2NX	BM7A 6521	AG3C	B6ES 7310	AGR32CU	BPR6ES 7822	ASF52	BPR4FS 1127
A3CU	B6S 3510	AG3X	B6ES 7310	AGR34CU	BPR6EY 6427	ASF52-6	BPR4FS-15 2727
A3NX	BM6A 5921	AG32A	BP6ES 7811	AGR41	BR5ES 4722	ASF52C	BPR5FS 2423
A3X	B6S 3510	AG32C	BP6ES 7811	AGR42	BPR5ES 7422	AT1	B8S 3810
A42	BP5S 3011	AG32CU	BP6ES 7811	AGR42C	BPR5ES 7422	AT10	B2 3110
A42CU	BP5S 3011	AG4	B5ES 6410	AGR42CU	BPR5ES 7422	AT2	B7S 3710
A5	B6S 3510	AG403	B10EGP 5224	AGR44CU	BPR5EY 2828	AT3	B6S 3510
A5CU	B6S 3510	AG403C	B10EGP 5224	AGR44CU-11	BPR5EY-11 3028	AT4	B6S 3510
A5X	B6S 3510	AG42	BP5ES 6511	AGR51	BR5ES 4722	AT42	BP5S 3011
A52	BP5S 3011	AG42CU	BP5ES 6511	AGR52	BPR5ES 7422	AT6	B6S 3510
A52CU	BP5S 3011	AG44	ZGR5C 6334	AGR701X	BR9EIX 3981	AT8	B4 3210
A7	B4 3210	AG44CU	BP5EY 7327	AGR82	BPR4ES 7222	ATL3	B6L 3212
A7LM	B4LM 3410	AG5	B5ES 6410	AGR901X	BR8EIX 5044	ATL4	B6L 3212
A7N	BM6A 5921	AG501X	BR10EIX 6801	AGRF22	BPR6EFS 3623	ATL8	B4L 3112
A7NU	BM6A 5921	AG52	BP5ES 6511	AGRF22C	BPR6EFS 3623	AV1X	B8HS 5510
A7NX	BM6A 5921	AG54	ZGR5C 6334	AGRF22C1	BPR6EFS 3623	AV22CU	BP6HS 4511
A7U	B4 3210	AG5CU	B5ES 6410	AGRF22PP1	PTR5D-10 3784	AV2CU	B7HS 5110
A7X	B4 3210	AG7	B5ES 6410	AGRF32	BPR6EFS 3623	AV2X	B7HS 5110
A82	BP4 2911	AG701	B9ES 2611	AGRF32C1	BPR6EFS 3623	AV3CU	B6HS 4510
A9	B4 3210	AG701C	B9ES 2611	AGRF42	BPR5EFS 2223	AV4	B5HS 4210
A901	B8S 3810	AG701CU	B9ES 2611	AGRF52	BPR5EFS 2223	AV42	BP5HS 4111
A9X	B4 3210	AG701X	BR9EIX 3981	AGRP52	ZFR4F-11 4043	AV52	BP5HS 4111
AE1C	B7HS 5110	AG9	B4ES 4129	AGS22C	BPR6ES 7822	AV6	B4H 4110
AE1X	B7HS 5110	AG9U	B4ES 4129	AGS32C	BPR5ES 7422	AV6CU	B4H 4110
AE2	B7HS 5110	AG901	B9ES 2611	AGS32C-11	BPR5ES-11 4424	AV701CU10	B9HS-10 3626
AE2C	B7HS 5110	AG901C	B9ES 2611	AGSF22FSM	TR6AP-13E 4968	AV82	BP4HS 3611
AE2X	B7HS 5110	AG901CU	B9ES 2611	AGSF22PPJ	PTR6F-13 7569	AV82CU	B9HS 5810
AE22	BP6HS 4511	AG901X	BR8EIX 5044	AGSF32C	BPR5EFS 2223	AV901X-4	B9HS-10 3626
AE22C	BP6HS 4511	AG902	BP8ES 2912	AGSF32FM	PTR5D-13 6644	AVKO	BUH 2422
AE3	B6HS 4510	AG903	B8EG 3430	AGSP32	BCPR6ES-11 7121	AVKOD	BUHW 2622
AE3X	B6HS 4510	AGF12	BP7EFS 3526	AGSP32C	BCPR6ES-11 7121	AVZKO	BUHX 2522
AE32	BP6HS 4511	AGF12C	BP7EFS 3526	AGSP33C	ZFR6F-11 4291	AWRF32	BPR6EFS 3623
AE32C	BP6HS 4511	AGF22C	BP6EFS 3812	AGSP52	BKR5E 7938	AWRF42	BPR5EFS 2223
AE3C	B6HS 4510	AGF22CU	BP6EFS 3812	AL11	B4L 3112	AWSF22C	BPR6EFS 3623
AE4	B5HS 4210	AGFS22C1	BPR5EFS 2223	AL5	B6L 3212	AWSF22FS	PTR6D-13 5598
AE4X	B5HS 4210	AGFS22CM1	BPR5EFS 2223	AL5X	B6L 3212	AWSF32	BPR6EFS 3623
AE42	BP5HS 4111	AGFS22F13J	TR6AP-13 5809	AL7	B6L 3212	AWSF32C	BPR6EFS 3623
AE6	B5HS 4210	AGFS22FE13J	PTR6F-13 7569	AL7U	B6L 3212	AWSF32F	PTR5D-10 3784
AE62	BP5HS 4111	AGFS22IPJ	ITR6F13 4477	AL7X	B6L 3212	AWSF32P	PTR5D-10 3784
AE7	B4H 4110	AGKO	BUE 2322	AL9	B4L 3112	AWSF32PM	PTR5D-10 3784
AE901	B9HS 5810	AGN42	BP5ES 6511	AL9X	B4L 3112	AWSF32PP	PTR5D-10 3784
AE901X	B9HS-10 3626	AGP12C	BCP7ES 5030	AR21X	BR6S 3522	AWSF42	BPR5EFS 2223
AER32	BPR6HS 7022	AGP22C	BCP6ES 4930	AR31	BR6S 3522	AWSF42C	BPR5EFS 2223
AER4	BR5HS 3722	AGP701C	R7435-10 4897	AR41	BR6S 3522	AWSF52C	BPR5EFS 2223
AER4X	BR5HS 3722	AGPR12C	BCPR7ES 3330	AR42	BP5S 3011	AWSFA32C	BPR5EFS 2223
AF12	BP7FS 3612	AGPR12PP8	PFR7B 4853	AR51	BR6S 3522	AYFS092FEC	PLTR6A-10G 3587
A-2	B7FS 3027	AGPR22C	BKR6E 6962	AR52	BP5S 3011	AYFS22C	TR5A-10 0005
AF22	BP6FS 3512	AGPR22C1	BCPR6ES-11 7121	AR7N	BMR6A 7421	AYFS22CB	TR5B-13 4559
AF32	BP6FS 3512	AGPR22CD	BKR6E 6962	AR82	BP4 2911	AYFS22FE1J	PLTR6A-10G 3587
AF3NX	BM7F 6421	AGPR22CD1	BCPR6ES-11 7121	ARF2	BR6FS 4323	AYFS22P1	PTR5A-10 5055
AF42	BP5FS 3412	AGPR22PP	PFR6B-11 4014	ARF22	BPR6FS 2623	AYFS22PP1	PTR5A-10 5055
AF5NX	BM6F 6221	AGPR22PPJ	PFR6B-11 4014	ARF22C	BPR6FS 2623	AYFS32CJ	TR5B-13 4559
AG1	B8ES 2411	AGPR32C	BKR6E 6962	ARF22CU	BPR6FS 2623	AYRF22PP	PTR5A-10 5055
		AGPR32CD1	BCPR6ES-11 7121	ARF3	BR6FS 4323	AYSF32YPC	ILTR5A-13G 3811
		AGPR32PD	BKR5EKUP 2890	ARF32	BPR6FS 2623	AZ2	B7S 3710
		AGPR902P	R7436-9 4899	ARF32-6	BPR6FS 2623	AZ3	B6S 3510
		AGPS22C	BCPR6ES 2330	ARF32C-6	BPR6FS 2623	AZ9	B4 3210

MOTORCRAFT	NGK → STOCK No.	NGK	NGK → STOCK No.	NGK	NGK → STOCK No.	NISSAN	NGK → STOCK No.				
AZ901	B8S	3810	2176	Obsolete	-	B8EGV	BR8EIX	5044	-12E17	BCPR7ES	3330
AZFS22PP	PTR5A-10	5055	2210	Obsolete	-	B8EVX	BR8EIX	5044	-1P115	PFR5G-11	2647
AZFS32FE	PTR5A-10	5055	2254	BR9HIX	5687	B8HVX	BR8HIX	7001	-1P116	PFR6G-11	5555
B2W	AB8	7909	2393	BPR6HS	7022	B9EGV	Obsolete	-	-1P117	PFR7G-11S	7772
B3W	AB7	3010	2434	BR9ECMIX	2707	B9EVX	BR9EIX	3981	-20J05	BKR5E	7938
B3X	AB7	3010	2457	BR10ECMIX	3006	B9HVX	BR9HIX	5687	-20J06	BKR6E	6962
B4X	AB7	3010	2634	BR8HIX	7001	B95EGV	BR10EIX	6801	-20J07	BKR7E	6097
B6W	AB6	2910	2671	BPR8EIX	6684	B95EVX	BCPR5EIX	5688	22401-00Q0K	ILKAR7F7G	90061
B8X	AB6	2910	2834	DR9EIX	4772	BCP6EVX	BCPR6EIX	5689	22401-1HA1C	DILKAR7E11HS	97439
BF12	AP8FS	2227	2844	Obsolete	-	BCP7EVX	BCPR7EIX	5690	22401-1HC1B	LZKAR6AP-11	6643
BF22	AP6FS	2710	2850	DR8EIX	6681	BKR5EVXA-13	PFR5G-13E	2761	22401-1KC1C	DILKAR7C9H	91215
BF22C	AP6FS	2710	2940	BR10HIX	6692	BKR6EVX	BKR6EIX	6418	22401-1KT1B	DILZKAR6A11	91691
BF22CU	AP6FS	2710	2946	R0045Q-10	4216	BKR6EVXA-11	PFR6G-13E	2341	22401-1P115	PFR5G-11	2647
BF22CX	AP6FS	2710	2989	AP6FS	2710	BKR7EVX	BKR7EIX	2667	22401-2047R	ILKAR7F7G	90061
BF22X	AP6FS	2710	3334	Obsolete	-	BL6H	Obsolete	-	22401-27N65	PFR5B-11	2300
BF32	AP6FS	2710	3344	TR7IX	96090	BP5EA-L	BP5EY	7327	22401-5M015	PLFR5A-11	6240
BF32CU	AP6FS	2710	3436	GR4IX	97382	BP5EVX	BPR5EIX	6597	22401-8H516	LFR6A-11	3672
BF32CX	AP6FS	2710	3539	BKR6EIX	6418	BP6EVX	BPR6EIX	6637	22401-9133R	ILKAR7J7G	91121
BF32X	AP6FS	2710	3544	BKR7EIX	2667	BP7EFVX	TR7IX	96090	22401-BC01B	LFR5E-11	1669
BR8	AB6	2910	4383	Obsolete	-	BP7EVX	BPR7EIX	4055	22401-CK81B	PLZKAR6A-11	5118
BRF22	APR6FS	2922	4741	R7376-9	7763	BP8EVX	BPR8EIX	6684	22401-CK87B	PLZKAR6A-11	5118
BRF22C	APR6FS	2922	4768	FR2B-D	1598	BPR4EVX	GR4IX	97382	22401-ED815	LZKAR6AP-11	6643
BRF32	APR6FS	2922	4795	DCPR7E-N-10	4983	BPR5EA-L-11	BPR5EY-11	3028	22401-EW61C	DF7H-11B	1317
BRF42	APR5FS	3122	4875	BPR5EIX	6597	BPR5EVX	BPR5EIX	6597	22401-FU412	FR2B-D	1598
BRF82	APR5FS	3122	4880	IZFR6B	3116	BPR6EFIX-10	BPR6EFIX-10	94658	22401-FU42A	FR2B-D	1598
BSF32C	APR6FS	2922	5066	DIMR8C10	92743	BPR6EVX	BPR6EIX	6637	22401-JA01B	DILKAR6A11	9029
BSF42C	APR5FS	3122	5470	BPR5EIX	6597	BPR6H-VG4	BPR6HS	7022	22401-JD01B	PLZKAR6A-11	5118
BSF82	APR5FS	3122	5567	BR8ECMIX	3520	BPR7EY	BPR7EIX	4055	22401-JF01D	DILKAR8A8	93026
BSF92	APR5FS	3122	5576	BPR9EIX	6853	BPR9EVX	BPR9EIX	6853	22401-JK01D	DF8H-11B	1305
BT10	AB6	2910	5627	BR8EIX	5044	BPZ7HS-10	Obsolete	-	22401-L1600	BPR4ES	7222
BT15	AB2	3020	5664	BCPR5EIX	5688	BR10ECMVX	BR10ECMIX	3006	22401-M7716	B6ES	7310
BT2	AB8	7909	5756	IKR9J8	93311	BR8ECMVX	BR8ECMIX	3520	22401-RS345-8	R7345-8	4379
BT3	AB7	3010	5827	BR9EIX	3981	BR9ECMVX	BR9ECMIX	2707	22401-V1414	BPR4ES	7222
BT4	AB7	3010	5832	BPR6EIX	6637	CR8HVX	CR8HIX	7669	22401-W8914	BPR4ES	7222
BT6	AB6	2910	5843	PLZKBR7B8DG	90223	D8EVX	DR8EIX	6681	BY483-HB6AX	HB6AIX-11P	5703
BT8	AB6	2910	5927	BR10EIX	6801	D9EVX	DR9EIX	4772	BY483-HB6BX	HB6BIX-11P	5705
BT9	AB6	2910	5992	ILZKBR7B8G	97968	DCPR7E-N	DCPR7E-N-10	4983	CK913628	AB-6	2910
BTRF42	APR5FS	3122	6044	TR5AI-13	90813	DCPR7EVX	DCPR7EIX	6046	N-22401-M7716	B6ES	7310
BZ8	AB6	2910	6111	BP5EY	7327	DCPR9EVX	DCPR9EIX	2316	NF90420-01620	PTR5D-10	3784
CYFS12YPC	ILTR6G8G	96621	6223	BPR5EY-11	3028	DIMR8A10	DIMR8C10	92743	-30R15	ZFR5E-11	4435
CYFS13YRC	ILZTR6A8G	94769	6323	BCPR6EIX	5689	DIMR8B10	DIMR8C10	92743	-50Y05	BKR5E-11	6953
HG2	D8EA	2120	6361	DR9EIX	4772	DPR7EVX-9	DPR7EIX-9	7803	-50Y06	BKR6E-11	2756
HG22	D8EA	2120	6436	DCPR9EIX	2316	DR9EVX	DR9EIX	4772	-53J05	BKR5EY	7390
HG2CU	D8EA	2120	6764	BPR6EIX	6637	FR2A-D	FR2B-D	4768	-53J06	BKR6EY	3696
HGR2C	DR8ES-L	2923	6838	PFR6G-13E	2341	IKR9F8	IKR9J8	93311	-53J16	PFR6G-9	4377
HV2	D8HA	7112	6891	BPR6EFIX-10	94658	ILKAR6C10	ILKAR7C10	94940	-53J66	PFR6G-9	4377
HV22	D6HA	6512	6921	Obsolete	-	ILZKBR7A-8G	ILZKBR7B8G	97968	-58S16	PFR6A-11	4045
HV3	D6HA	6512	6934	BR7EIX	2667	ILZKBR7B8DG	ILZKBR7B8G	97968	-85E15	BKR5E-11	6953
HYFS094YEC	ILZNAR8A7G	91924	7043	R0045Q-11	5957	IKR9F8	IKR9G8	97168	-85E16	BKR6E-11	2756
PV2	C7HSA	4629	7051	BR8EIX	5044	ME-8	Obsolete	-	-85E17	BKR7E-11	1283
PV3	C6HSA	3228	7149	GR4IX	97382	PLZKBR7A-G	PLZKBR7B8DG	90223	-99B07	BCPR7ES-11	1095
TT4	G2Z	3320	7236	CR8HIX	7669	R0045G-10	R0045Q-10	4216	-99B09	BCPR6ES-11	7121
TT8	G2Z	3320	7254	BR9EIX	3981	R0045J-11	R0045Q-11	5957	-99B12	BCPR5ES-11	3524
YN2F-12405A2A	TR5B-13	4559	7270	BPR7EIX	4055	R5184-105	Obsolete	-	-F2000	BPR4ES	7222
			7335	BR10EIX	6801	R5525-11	Obsolete	-	-P8315	BPR5ES-11	4424
			7681	BCPR7EIX	5690	R6251E-9	R7376-9	7763	-P8316	BPR6ES-11	4824
			7682	DPR7EIX-9	7803	NHSP LD - See CHINESE BRANDS					
			7836	BR7HIX	7067	NIPPON DENSO - See DENSO					
			94786	ILKR9G8	97168	NISSAN					
			95770	ILZKBR7B8G	97968						
			95843	ILKAR7C10	94940						
			A-6	AB-6	2910						
			A6FS	Obsolete	-						
			A-7	AB-7	3010						
			A-8	AB-8	7909						
			AP6F-VG	AP6FS	2710						
			B105EGP	Obsolete	-						
			B105EGV	Obsolete	-						
			B10EGV	BR10EIX	6801						
			B10EVX	BR10EIX	6801						
			B10HVX	BR10HIX	6692						
			B6EFS	BR6EF	3177						
			B7EVX	BR7EIX	2667						
			B7HVX	BR7HIX	7067						
			1010	AB-6	2910						
			1093	Obsolete	-						
			1110	AB-7	3010						
			1144	BPR7EIX	4055						
			1179	DCPR7EIX	6046						
			1188	PFR5G-13E	2761						
			1210	AB-8	7909						
			2042	BR6EF	3177						
			2077	Obsolete	-						
			2145	BR10EIX	6801						
			2171	Obsolete	-						
			2176	Obsolete	-						
			2210	Obsolete	-						
			2254	BR9HIX	5687						
			2393	BPR6HS	7022						
			2434	BR9ECMIX	2707						
			2457	BR10ECMIX	3006						
			2634	BR8HIX	7001						
			2671	BPR8EIX	6684						
			2834	DR9EIX	4772						
			2844	Obsolete	-						
			2850	DR8EIX	6681						
			2940	BR10HIX	6692						
			2946	R0045Q-10	4216						
			2989	AP6FS	2710						
			3334	Obsolete	-						
			3344	TR7IX	96090						
			3436	GR4IX	97382						
			3539	BKR6EIX	6418						
			3544	BKR7EIX	2667						
			4383	Obsolete	-						
			4741	R7376-9	7763						
			4768	FR2B-D	1598						
			4795	DCPR7E-N-10	4983						
			4875	BPR5EIX	6597						
			4880	IZFR6B	3116						
			5066	DIMR8C10	92743						
			5470	BPR5EIX	6597						
			5567	BR8ECMIX	3520						
			5576	BPR9EIX	6853						
			5627	BR8EIX	5044						
			5664	BCPR5EIX	5688						
			5756	IKR9J8	93311						
			5827	BR9EIX	3981						
			5832	BPR6EIX	6637						
			5843	PLZKBR7B8DG	90223						
			5927	BR10EIX	6801						
			5992	ILZKBR7B8G	97968						
			6044	TR5AI-13	90813						
			6111	BP5EY	7327						
			6223	BPR5EY-11	3028						
			6323	BCPR6EIX	5689						
			6361	DR9EIX	4772						
			6436	DCPR9EIX	2316						
			6764	BPR6EIX	6637						
			6838	PFR6G-13E	2341						
			6891	BPR6EFIX-10	94658						
			6921	Obsolete	-						
			6934	BR7EIX	2667						
			7043	R0045Q-11	5957						
			7051	BR8EIX	5044						
			7149	GR4IX	97382						
			7236	CR8HIX	7669						
			7254	BR9EIX	3981						
			7270	BPR7EIX	4055						

OMC	NGK → STOCK No.	PAL	NGK → STOCK No.	PEUGEOT	NGK → STOCK No.	PRESTOLITE	NGK → STOCK No.				
502196	BR6S	3522	L7Y	BP6ES	7811	5962.A0	BP7ES	2412	14-2X	B6S	3510
502894	BUZ8H	7447	L8	B6ES	7310	5962.C5	BKR6ES	3783	14-3	B6S	3510
503948	BPR6HS	7022	L8Y	BP6ES	7811	5962.C6	BKR6ES	3783	14-3N	BM7A	6521
503949	BR6HS	3922	L9Y	BP7ES	2412	5962.C0	BP5EFS	3712	14-3X	B6S	3510
503950	BR6HS	3922	LR12YC	BPR8ES	3923	5962.E2	BCP6ES	4930	14-4	B6S	3510
504082	BR6HS	3922	LR14YC	BPR7ES	2023	5962.F7	BCP6ES	4930	14-42	BP5S	3011
509921	BUHW	2622	LR15YC	BPR6ES	7822	5962.F8	BCP6ES	4930	14-5	B6S	3510
509922	BUHW-2	5626	N12YC	BP8ES	2912	5962.G8	BP7ES	2412	14-5X	B6S	3510
509924	BUZ8H	7447	N14C	B9HS	5810	5962.H2	BKR6ES	3783	14-52	BP5S	3011
509925	BZ7HS-10	3579	N14YC	BP7HS	5111	5962.H8	BKR5E	7938	14-7	B4	3210
509926	BUHXW-1	5526	N15C	B7ES	1111	5962.H9	BCPR5ES	6130	14-7N	BM6A	5921
509928	B6S	3510	N15YC	BP6HS	4511	5962.J9	BKR6ES	3783	14-7X	B4	3210
509929	B7HS	5110	N17C	B6HS	4510	5962.J0	BCP6ES	4930	14-82	BP4	2911
584918	DCPR7E	3932	N17Y	BP4HS	3611	5962.K1	BCPR7ES	3330	14-9	B4	3210
771770	BUZHW-2	2173	N17YC	BP5HS	4111	5962.K3	BCP7ET	2078	14-9X	B4	3210
			N19	B4H	4110	5962.K4	BKR6ES	3783	14E1	B8HS	5510
OPEL - See VAUXHALL			N19C	B5HS	4210	5962.K6	BKR6ES	3783	14E01	BUH	2422
OREGON - See BRISK			N7	B6HS	4510	5962.K7	BCPR6ET	2197	14E2	B7HS	5110
			N7Y	BP6HS	4511	5962.K0	BCPR7ES	3330	14E3	B6HS	4510
			N8	B7HS	5110	5962.R5	BCPR6ET	2197	14E4	B5HS	4210
			N8Y	BP7HS	5111	5962.R9	BKR6ES	3783	14E6	B5HS	4210
			NR12YC	BPR8HS	3725	59627Q	BKR6EZ	4619	14E22	BP7HS	5111
			NR15YC	BPR6HS	7022	5962.S2	BKR6E	6962	14E32	BP6HS	4511
			P15	BM7A	6521	5962.S4	BKR5E	7938	14E42	BP6HS	4511
			P15Y	BPM7A	7321	5962.T8	BKR6ES	3783	14E52	BP5HS	4111
			P17	BM6A	5921	5962.V6	BKR5E	7938	14E62	BP5HS	4111
			P17Y	BPM6A	7021	5962.V7	BKR6ES	3783	14E82	BP4HS	3611
			PR15Y	BPMR7A	4626	5962.V8	BCPR7ES	3330	14ER4	BR6HS	3922
			PR17Y	BPMR6A	6726	5962.W4	BCPR6ET	2197	14ER6	BR6HS	3922
			S14L-13	B8EG	3430	5962.W6	BCPR7ES	3330	14F22	BP6FS	3512
			S14L-15	B9EG	3530	5962.W7	BCPR7ES	3330	14F32	BP6FS	3512
			S14L-17	B10EG	3630	5962.W9	BKR5EK	7956	14F3N	BM7F	6421
			U17	BM6F	6221	5962.X5	BCP6ES	4930	14F42	BP5FS	3412
						5962.Y2	BKR5EK	7956	14F52	BPR4FS	1127
						5962.Y8	BKR6EK	2288	14F7N	BM6F	6221
						5962.Z0	BKR6EK	2288	14G01	BUE	2322
						800942	CR9EB	6955	14G1	B8ES	2411
						96 762 88 180	LZKR6AI-10G	97999	14G12	BP8ES	2912
						96 774 469 80	ILZKR8C8G	90909	14G2	B7ES	1111
						PE781757	CPR9EB-9	6508	14G22	BP6ES	7811
						V 7534226803 03	PLZKBR7B8DG	90223	14G3	B6ES	7310
									14G32	BP5ES	6511
									14G4	B6ES	7310
									14G42	BP5ES	6511
									14G5	B5ES	6410
									14G52	BP5ES	6511
									14G7	B5ES	6410
									14G902	BP8ES	2912
									14GF22	BP6EFS	3812
									14GR22	BPR6ES	7822
									14GR32	BPR5ES	7422
									14GR4	BR6ES	4922
									14GR42	BPR5ES	7422
									14GR52	BPR4ES	7222
									14GR53	ZGR5C	6334
									14GR7	BR5ES	4722
									14GRF22	BPR6EFS	3623
									14GRF32	BPR5EFS	2223
									14GRF52	BPR5EFS	2223
									14L4	B6L	3212
									14L7	B6L	3212
									14L9	B4L	3112
									14R3	BR6S	3522
									14R32	BP5S	3011
									14R4	BR6S	3522
									14R42	BP5S	3011
									14R5	BR6S	3522
									14R52	BP4	2911
									14R53	BP4	2911
									14R7N	BM6A	5921
									14R8	B6S	3510
									14RF22	BPR6FS	2623
									14RF32	BPR5FS	2423
									14RF32-6	BPR5FS-15	3124

PRESTOLITE	NGK → STOCK No.
14RF32A	BPR5FS-15 3124
14RF42	BPR5FS 2423
14RF42-6	BPR5FS-15 3124
14RF42A	BPR5FS-15 3124
14RF52	BPR4FS 1127
14RF52-6	BPR4FS-15 2727
14RF52A	BPR4FS-15 2727
14RF62	BPR4FS 1127
14RF62-6	BPR4FS-15 2727
14RF62A	BPR4FS-15 2727
18-3	AB6 2910
18-4	AB6 2910
18-8	AB6 2910
18-9	AB6 2910
18-10	AB6 2910
18F22	AP6FS 2710
18F32	AP6FS 2710
18RF32	APR6FS 2922
18RF42	APR6FS 2922
18RF82	APR6FS 2922
1Y00-18-110	BPR5ES 7422
394	B6ES 7310
4056	B6ES 7310
4253	BP5EY 7327
43N	B6ES 7310
43XL	B6ES 7310
44N	B6ES 7310
44NS	BP5EY 7327
44XL	B6ES 7310
78-10	GZZ 3320
78-8	GZZ 3320
AG3	B6ES 7310
AG30C	B6ES 7310
AG30X	B6ES 7310
AG3X	B6ES 7310
B2401-89904	BP5EY 7327
C43N	B6ES 7310
C44N	B6ES 7310
C44NS	BP5EY 7327
MS851243	BP5EY 7327
N288	B6ES 7310
N5C	B6ES 7310
S43XL	B6ES 7310
S44XL	B6ES 7310
PROTECNICA	NGK → STOCK No.
4708	BR2LM 5798
4843	BPM7A 7321
PROTON	NGK → STOCK No.
8200030765	LZKAR7A 6799
MS851232E	BPR5ES 7422
MS851233E	BPR6ES 7822
MS851358E	BKR6E-11 2756
PW811750	BPR6EF-11 95420
LAP6FS	AP6FS 2710
LBCPR6ES	BCPR6ES 2330
LBCP6ES	BCP6ES 4930
LBP6EFS	BPR6EFS 3623
LBP5ES	BP5ES 6511
LBP6EFS	BP6EFS 3812
LBP6ES	BP6ES 7811
PW811750	BPR6EF-11 95420
RAM - See CHRYSLER GROUP	
RENAULT	NGK → STOCK No.
22401-8760R	LZKAR7B 5942
22401-9133R	ILKAR7J7G 91121
77 00 101 401	BCPR5ES 6130
77 00 103 502	BPR5ES 7422
77 00 103 503	BPR5ES 7422
77 00 103 533	BKR5EK 7956
77 00 107 916	BKR5EK 7956

RENAULT	NGK → STOCK No.
77 00 260 637	BCP7ET 2078
77 00 266 295	BPR6EFS 3623
77 00 267 140	BPR6EFS 3623
77 00 267 805	TR7IX 96090
77 00 273 462	BKR6E 6962
77 00 273 698	BKR6EIX 6418
77 00 500 155	BKR6EZ 4619
77 00 500 168	BKR5EK 7956
77 00 500 192	LFR4AP-11 5613
77 00 553 622	BP6ES 7811
77 00 565 155	BR9EIX 3981
77 00 587 168	BP6HS 4511
77 00 714 540	BPR6EFS 3623
77 00 722 095	BP6EFS 3812
77 00 724 821	BP6ES 7811
77 00 725 302	BPR5ES 7422
77 00 726 503	BP7EFS 3526
77 00 727 383	BPR6ES 7822
77 00 731 583	BP7EFS 3526
77 00 732 626	BP8ES 2912
77 00 733 422	BP5HS 4111
77 00 736 149	BP7EFS 3526
77 00 736 150	BP7EFS 3526
77 00 737 457	BP7EFS 3526
77 00 737 458	BP6EFS 3812
77 00 737 459	BP7ES 2412
77 00 737 612	BCP5ES 7496
77 00 742 094	BR7ES 2023
77 00 743 137	BCP5ES 7496
77 00 743 920	BP5ES 6511
77 00 749 163	BCP5ES 7496
77 00 824 821	BP6ES 7811
77 00 852 522	BP6EFS 3812
77 00 852 543	TR7IX 96090
77 00 855 463	BCP6ET 4563
77 00 855 918	BP5EFS 3712
77 00 856 342	BCP6ET 4563
77 00 859 910	BCP5ES 7496
77 00 859 967	BP5ES 6511
77 00 861 471	BP7ES 2412
77 00 861 472	BP6ESZ 7639
77 00 862 054	BP5ES 6511
77 00 868 864	BPR7ES 2023
77 00 871 617	BCPR6ET 2197
77 01 021 767	BP6EFS 3812
77 01 041 214	BP5ES 6511
77 01 041 215	BP6EFS 3812
77 01 042 816	BKR6E 6962
77 01 043 624	BCPR6ET 2197
77 01 045 018	BP7EFS 3526
77 01 065 085	PLZKAR6A-11 5118
77 01 366 057	BP6HS 4511
77 01 366 084	BR8EIX 5044
77 01 366 085	BR7EIX 6664
77 01 366 086	BP6ES 7811
77 01 366 087	BP7ES 2412
77 01 366 137	BP6EFS 3812
77 01 366 267	BP6HS 4511
77 01 366 268	BP7ES 2412
77 01 366 269	BP6ES 7811
77 01 366 270	BP6EFS 3812
77 01 366 513	BP5HS 4111
77 01 366 514	BP6EFS 3812
77 01 366 515	BP6HS 4511
77 01 366 516	BP6ES 7811
77 01 366 533	B6HS 4510
77 01 366 539	BP5ES 6511
77 01 366 903	BP5ES 6511
77 01 414 022	BP5HS 4111
77 01 414 025	BP6ES 7811
77 01 414 026	BP7EFS 3526
77 01 414 027	BP7EFS 3526
77 01 414 031	BPR6ES 7822
82 00 030 765	LZKAR7A 6799

RENAULT	NGK → STOCK No.
82 00 020 796	BKR6EZ 4619
82 00 314 928	PFR7G-9 4371
82 00 322 273	LZKAR7A 6799
82 00 363 384	PFR6G-9 4377
82 00 492 426	PFR7Z-TG 5768
82 00 587 901	ILKAR7A7 91432
82 00 592 215	LZKAR7B 5942
82 00 662 185	LZKAR7A 6799
82 01 001 947	IFR7X8G 95820
83 04 504 277	ZFR5F 5165
89 33 003 862	BKR6ES 3783
96 26 575 480	BKR6EK 2288
SAAB	NGK → STOCK No.
12620540	ILTR5D 5476
12788884	PLFR6C-10G 1959
55564215	BKR7ESC-11 6313
55571391	PFR6T-10G 5542
8819302	BCPR7EIX 5690
9112541	BCPR7ES-11 1095
9117565	BCPR6ES-11 7121
9136276	BCPR5EIX 5688
9139643	BCPR6EIX 5689
9399866	PFR6H-10 6290
SEAT - See VW GROUP	
SKODA - See VW GROUP	
SMART	NGK → STOCK No.
000 3085 V005 0000 00	BKR6EKE 5649
001 2468 V002 000 00	LZKR8A 5214
A 003 159 92 03	BKR6EKE 5649
SPLITFIRE	NGK → STOCK No.
TP006A	BPR8EIX 6684
TP006B	BPR7EIX 4055
TP006C	BPR6EIX 6637
TP006D	BPR5EIX 6597
TP006E	BPR5EIX 6597
TP406B	BR9EIX 3981
TP406B	BR9EIX 3981
TP406C	BR8EIX 5044
TP406C	BR8EIX 5044
TP430B	CR9EIX 3521
TP430C	CR8EIX 4218
STEINBOCK	NGK → STOCK No.
8155723	BPR4FS 1127
STIHL	NGK → STOCK No.
144483	BP2ES 3467
0000-400-7009	CMR6H 3365
0000-400-7011	CMR6H 3365
SUBARU	NGK → STOCK No.
22401AA020	BP6ES 7811
22401AA090	BP7ES 2412
22401AA120	BPR6ES-11 4824
22401AA220	BPR6ES 7822
22401AA230	BPR7E 1142
22401AA310	BKR6E-11 2756
22401AA370	PFR6B-11 4014
22401AA400	PFR6B 3500
22401AA480	BPR5ES-11 4424
22401AA500	BKR6EIX-11 3764
22401AA510	BKR6EIX 6418
22401AA530	PFR6B 3500
22401AA531	PFR6B 3500
22401AA570	PFR6B 3500
22401AA630	ILFR6B 6481
22401AA670	SILFR6A 7913
22401AA720	SILFR6A11 5468
22401AA730	SIFR6A11 0127

SUBARU	NGK → STOCK No.
22401AA740	SILFR6A6 8659
22401AA830	ILKAR8H6 96024
22401KA080	BKR6E 6962
22401KA100	BCPR6E 1269
22401KA210	BKR5E-11 6953
320540800	B6ES 7310
320541110	B7ES 1111
320541120	BR7EIX 6664
320545700	BR6ES 4922
382420800	B5ES 6410
420543200	BP5ES 6511
490010003	BPR5EIX 6597
490010013	BPR6EIX 6637
490010023	BPR7EIX 4055
490010033	BPR5ES 7422
490010043	BP5EY 7327
490010053	BP6EY 7727
820541810	B6HS 4510
820546010	B8HS 5510
820548020	BR8HIX 7001
820549310	B7HS 5110
820549320	BR7HIX 7067
882417800	B5HS 4210
890573400	B6S 3510
SUZUKI	NGK → STOCK No.
04982-00584	CR8EIB-10 4948
04982-00597	CR8EIA-10 4708
04982-02EA1	ZMR7AP 6914
04982-00036	BP4HS 3611
04982-00066	B9ES 2611
04982-00082	B7HS 5110
04982-00084	BP6HS 4511
04982-00088	BR6HS 3922
04982-00089	B7ES 1111
04982-00091	B8ES 2411
04982-00095	B6HS 4510
04982-00098	BR9ES 5722
04982-00102	BR8HS 4322
04982-00105	BP7HS 5111
04982-00115	BR9EIX 3981
04982-00116	BR7HS 4122
04982-00117	BR7ES 5122
04982-00118	BP6ES 7811
04982-00121	BR8ES 5422
04982-00124	BP5HS 4111
04982-00127	BR9ES 5722
04982-00131	BP5ES 6511
04982-00136	BPR4HS 7823
04982-00139	BP7ES 2412
04982-00141	BPR6HS 7022
04982-00143	BR5HS 3722
04982-00144	D8EA 2120
04982-00147	BPR5HS 6222
04982-00149	DR8ES-L 2923
04982-00155	BPR5ES 7422
04982-00157	BR8HS 4322
04982-00167-000	BPR5EY 2828
04982-00167-001	BPR5ES 7422
04982-00167	BPR5ES 7422
04982-00175	BP8ES 2912
04982-00177	BP6ES 7811
04982-00181	BR10EIX 6801
04982-00182	D7EA 7912
04982-00184	D9EA 2420
04982-00198	B8HS 5510
04982-00205	BPR4HS 7823
04982-00208	BR8EIX 5044
04982-00209	BR9EIX 3981
04982-00210	BR10EIX 6801
04982-00220	DR7ES 3123
04982-00221	DR8ES 5423
04982-00229	BPR6ES 7822
04982-00230	BR8HS 4322

YALE	NGK → STOCK No.	
150015100	AB-6	2910
150112405	AB-6	2910
150112406	AB-6	2910
150112407	AB-6	2910
150112408	AB-6	2910
150112409	AB-6	2910
150112410	AB-6	2910
150112411	AB-6	2910
150112413	AB-6	2910
150112420	AB-6	2910
150112427	AB-6	2910
150112453	BPR5FS	2423
150112466	BPR4ES	7222
150112473	BMR6A	7421
150112490	BMR6A	7421
150112494	BMR6A	7421
220007428	AB-6	2910
220010987	AB-6	2910
220011080	AB-6	2910
220011107	AB-6	2910
220011205	AB-6	2910
220013371	BPR4FS	1127
220052206	AB-6	2910
509295802	AB-6	2910
510764800	AB-6	2910
516484800	BPR5FS	2423
517451800	AB-6	2910
5059605-35	BPR2ES	2264
580000628	BPR4FS	1127
580005036	BPR5FS	2423
580008972	BPR5FS	2423
580013445	BPR5FS	2423
YAMAHA	NGK → STOCK No.	
14B-R465B-70	R0465B-10	7506
31926-KRM-841	CPR9EA-9	2308
90793 20029	BR10EIX	6801
90793 20030	B105EGV	2171
90793 20032	B10EG	3630
90890 78082	BR10EIX	6801
94700 00866	CPR8EA-9	2306
94701 00039	B6HS	4510
94701 00040	B7HS	5110
94701 00041	B8HS	5510
94701 00042	B9HS	5810
94701 00043	B6ES	7310
94701 00044	B7ES	1111
94701 00045	B8ES	2411
94701 00046	B9ES	2611
94701 00050	BP7HS	5111
94701 00061	BR8EIX	5044
94701 00063	BR9EIX	3981
94701 00069	B5HS	4210
94701 00078	B5ES	6410
94701 00108	BP6HS	4511
94701 00110	BR7HS	4122
94701 00111	BR6ES	4922
94701 00112	BR7ES	5122
94701 00113	BR8EIX	5044
94701 00116	BP6ES	7811
94701 00117	BP7ES	2412
94701 00118	BP8ES	2912
94701 00148	BR8HIX	7001
94701 00157	D8EA	2120
94701 00159	BP4HS	3611
94701 00160	B8HS-10	5126
94701 00168	BP5HS	4111
94701 00188	BR9ES	5722
94701 00189	D7EA	7912
94701 00193	BR9EIX	3981
94701 00194	BPR5HS	6222
94701 00195	BR8HS	4322
94701 00198	BPR6HS	7022
94701 00203	DR8ES-L	2923

YAMAHA	NGK → STOCK No.	
94701 00204	BR8ES	5422
94701 00208	DR7ES	3123
94701 00217	B7HS-10	2129
94701 00218	BPR7ES	2023
94701 00219	BPR8ES	3923
94701 00227	BPR7HS	6422
94701 00232	BP6HS-10	6326
94701 00234	BPR6ES	7822
94701 00237	BP8HS-10	3823
94701 00241	DPR8EA-9	4929
94701 00248	BR6HS	3922
94701 00250	CR7HS	7223
94701 00251	BR9HS	4522
94701 00254	C7HSA	4629
94701 00256	C6HSA	3228
94701 00258	BPR4HS	7823
94701 00262	DPR7EA-9	5129
94701 00264	BP7HS-10	7829
94701 00266	D9EA	2420
94701 00268	BP8HS	2630
94701 00273	B6HS-10	1052
94701 00274	BR6HS-10	1090
94701 00280	BPR8HS	3725
94701 00282	CR6HS	7023
94701 00284	BPR6EIX	6637
94701 00285	BPR6EIX	6637
94701 00287	DR8ES	5423
94701 00292	BPR6HS-10	2633
94701 00300	CR5HS	2874
94701 00309	BR9HS-10	4551
94701 00311	BR5ES	4722
94701 00318	CR9E	6263
94701 00328	BPR5ES	7422
94701 00330	CR8E	1275
94701 00333	DR8EA	7162
94701 00340	DR9EA	3437
94701 00345	DR7EA	7839
94701 00353	CR7E	4578
94701 00361	DPR9EA-9	5329
94701 00365	BR6FS	4323
94701 00372	CR6HSA	2983
94701 00375	DPR6EA-9	5531
94701 00395	CR9EK	4548
94701 00403	CR9EK	4548
94701 00406	DPR5EA-9	2887
94701 00408	CR9EIA-9	6289
94701 00422	LMAR7A-9	4908
94701 00434	LMAR8G	95627
94701 00436	LMAR8A-9	4313
94701 00441	MR9K-9	97162
94702 00044	B7ES	1111
94702 00045	B8ES	2411
94702 00046	B9ES	2611
94702 00149	B7HS	5110
94702 00188	BR9ES	5722
94702 00193	BR9EIX	3981
94702 00195	BR8HS	4322
94702 00204	BR8ES	5422
94702 00211	BPMR6A	6726
94702 00247	BR8HS-10	1134
94702 00248	BR6HS	3922
94702 00249	BR5HS	3722
94702 00271	BR7HS-10	1098
94702 00272	BR7HS	4122
94702 00274	BR6HS-10	1090
94702 00309	BR9HS-10	4551
94702 00317	B9HS-10	3626
94702 00323	B8EG	3430
94702 00324	BR9EG	3230
94702 00325	B9EG	3530
94702 00326	BR8EG	3130
94702 00331	BPR4ES	7222
94702 00343	BR4ES	1097
94702 00348	BPR2ES	2264

YAMAHA	NGK → STOCK No.	
94702 00349	BR7ES	5122
94702 00357	BR9ECM	3252
94702 00367	B10EG	3630
94702 00368	BR10EG	3830
94702 00372	CR6HSB	6500
94702 00391	LF5A-11	6376
94702 00400	LF6A-11	3672
94702 00404	BKR7EKU	5881
94702 00405	BKR6EKU	6993
94702 00409	CR9EB	6955
94702 00419	CR4HSB	4695
94702 00429	LKR7E	1643
94702 00437	LKR6E	92650
94703 00277	BR9EIX	3981
94703 00420	CPR7EA-9	3901
94709-00437	LKR6E	92650

YANMAR	NGK → STOCK No.	
124190-78010	BPR4ES	7222
160110-78011	B6HS	4510
160232-78010	B4H	4110
160560-78010	BPMR4A	6028
160610-78010	BP4HS	3611
160690-78010	BP6ES	7811
160693-78010	BPR6ES	7822
160769-78010	BR4HS	3322
160793-78010	BPR5ES	7422
160810-78010	BPR4HS	7823
160998-78010	BPR6EY	6427
181630-78010	BUHW	2622

YHX - See CHINESE BRANDS

ZENOAH	NGK → STOCK No.	
3699-92672	BPMR8Y	2218



SPARK PLUG COVERS

STANDARD PLUG COVERS



EPDM RUBBER PLUG COVERS



The NGK range of resistor covers are designed to give perfect noise suppression across all frequencies whilst engine performance is not adversely affected whatsoever.

Featuring a resistor element pressed in between the plug terminal and the high tension wire connection, the construction is extremely durable, the resistor element is long enough to prevent interior flashover, and steady resistance is maintained. Superlative ceramic materials are incorporated that resist deterioration and have small resistance variation under over-load, whilst the plug connector is made of sturdy phenolic resin, practically oblivious to tremendous heat and high tension, and very rugged rubber material. The heat press insertion makes the construction all the more tough and vibration-resistant. Special rubber liners on both ends prevent moisture from causing electrical leakage.

All motorcycle manufacturers now comply with current legislation which demands a standard of noise suppression on every vehicle. This is achieved usually by fitting NGK resistor covers though in many cases a combination of NGK resistor covers and NGK resistor spark plugs (R type) is necessary to satisfy the ministry tests. It is emphasized that despite the use of both resistor covers and spark plugs in such engines, due to the unique and superior construction of NGK products there is no loss of performance or shortening of service life.

LB05EMH and SD05FM being of tough EPDM rubber construction are intended for competition/trial applications.

COVER SYMBOLS EXPLANATION CHART

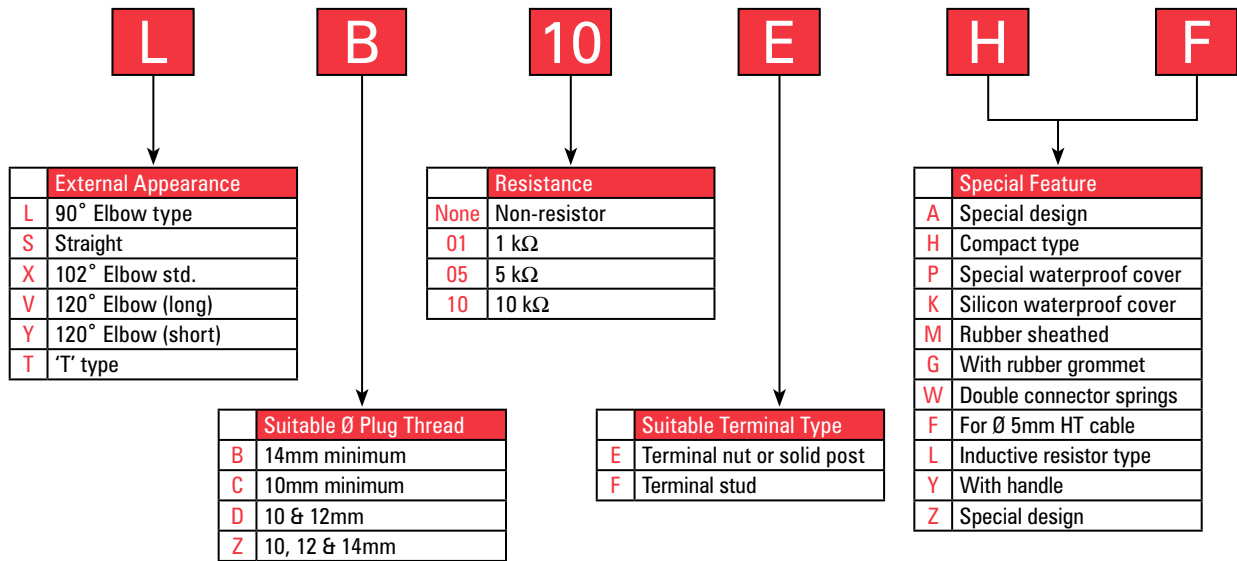

NGK RESISTOR PLUG COVERS

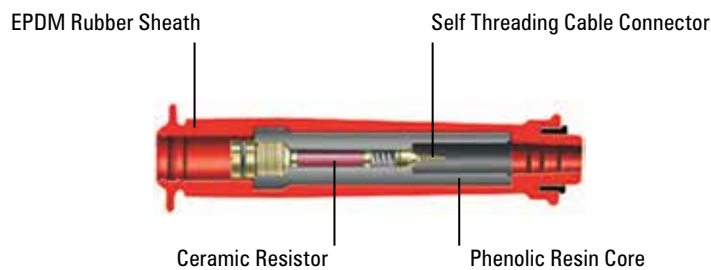
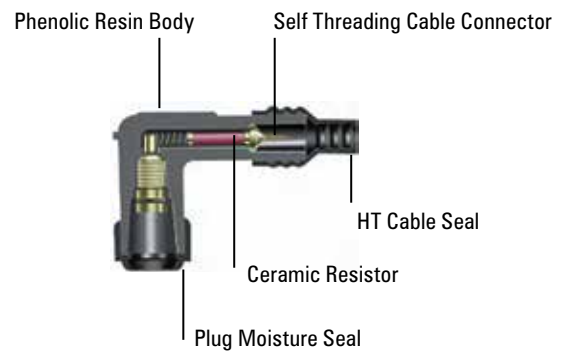
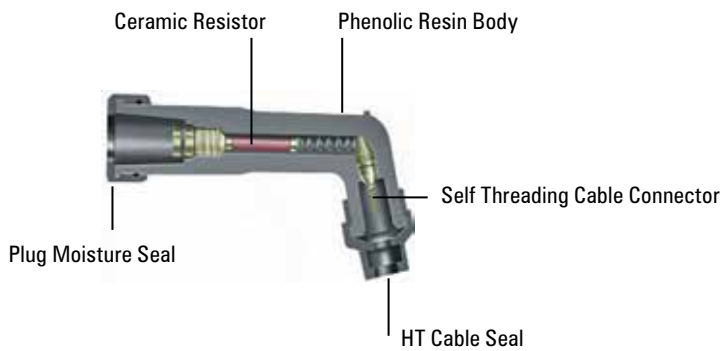

SPARK PLUG COVERS

Part No.	Stock No.	Colour	Resistor	Ø Plug	Terminal Type
LB05E	8031	Black	5 kΩ	14mm	
LB05E-R	8898	Red	5 kΩ	14mm	
LB05F	8051	Black	5 kΩ	14mm	
LB05F-R	8854	Red	5 kΩ	14mm	
LB10F-CS	8961	Black	10 kΩ	14mm	

Description: 90° Elbow Type Material: Phenolic Resin

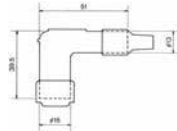

Part No.	Stock No.	Colour	Resistor	Ø Plug	Terminal Type
LZFH	8710	Black	None	10 - 14mm	

Description: 90° Non-resistor type Material: Phenolic Resin

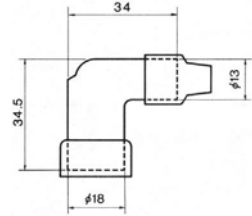

Part No.	Stock No.	Colour	Resistor	Ø Plug	Terminal Type
LB05EH	8334	Black	5 kΩ	14mm	
LB05EH-R	8688	Red	5 kΩ	14mm	
LB10EHF	8055	Black	10 kΩ	14mm	
LB10EHF-R	8058	Red	10 kΩ	14mm	

Description: 90° Elbow Type Material: Phenolic Resin

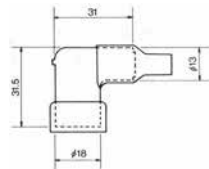

Part No.	Stock No.	Colour	Resistor	Ø Plug	Terminal Type
LB05EMH	8338	Black	5 kΩ	14mm	
LB05EMH-R	8160	Red	5 kΩ	14mm	

Description: 90° Rubber Sheathed Material: EPDM Rubber

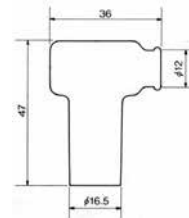

Part No.	Stock No.	Colour	Resistor	Ø Plug	Terminal Type
LD05F	8060	Black	5 kΩ	10 - 12mm	
LD05F-R	8231	Red	5 kΩ	10 - 12mm	

Description: 90° Elbow Type Material: Phenolic Resin

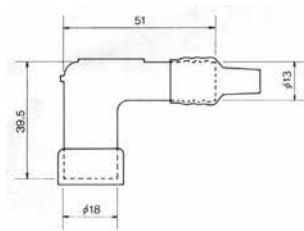

Part No.	Stock No.	Colour	Resistor	Ø Plug	Terminal Type
SB05E	8374	Black	5 kΩ	14mm	
SB05EC	8511	Red	5 kΩ	14mm	
SB05F	8080	Black	5 kΩ	14mm	
SB05F-R	8567	Red	5 kΩ	14mm	
SD05F	8022	Black	5 kΩ	10 - 12mm	
SD05F-R	8238	Red	5 kΩ	10 - 12mm	

Description: Straight Type Material: Phenolic Resin

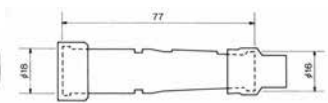

Part No.	Stock No.	Colour	Resistor	Ø Plug	Terminal Type
SD05FM	8392	Black	5 kΩ	10 - 12mm	
SD05FM-R	8673	Red	5 kΩ	10 - 12mm	

Description: Straight Rubber Sheathed Material: EPDM Rubber

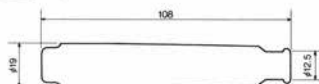

Part No.	Stock No.	Colour	Resistor	Ø Plug	Terminal Type
TB05EMA	8636	Black	5 kΩ	14mm	

Description: 90° Rubber Sheathed Material: Silicon Rubber

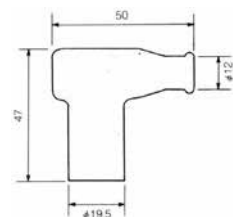

SPARK PLUG COVERS

Part No.	Stock No.	Colour	Resistor	Ø Plug	Terminal Type
XB05F	8062	Black	5 kΩ	14mm	
XB05F-R	8592	Red	5 kΩ	14mm	
XD05F	8072	Black	5 kΩ	10 - 12mm	
XD05F-R	8768	Red	5 kΩ	10 - 12mm	

Description: 102° Elbow Type Material: Phenolic Resin

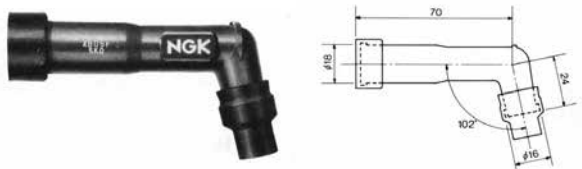

Part No.	Stock No.	Colour	Resistor	Ø Plug	Terminal Type
VB05F	8032	Black	5 kΩ	14mm	
VB05F-R	8759	Red	5 kΩ	14mm	
VD05F	8052	Black	5 kΩ	10 - 12mm	
VD05F-R	8376	Red	5 kΩ	10 - 12mm	
VD05EG	5817	Black	5 kΩ	10 - 12mm	

Description: 120° Elbow (Long) Type Material: Phenolic Resin



Part No.	Stock No.	Colour	Resistor	Ø Plug	Terminal Type
YB05F	8082	Black	5 kΩ	14mm	
YB05F-R	8162	Red	5 kΩ	14mm	

Description: 120° Elbow (Short) Type Material: Phenolic Resin

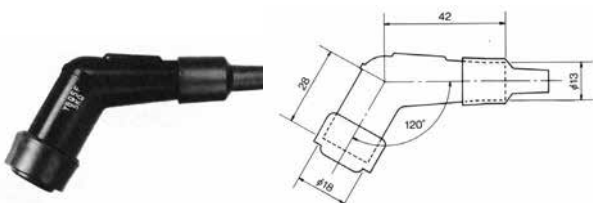

Part No.	Stock No.	Colour	Resistor	Ø Plug	Terminal Type
LBER-R	8307	Red	None	14mm	
LBER-B	8308	Blue	None	14mm	

Description: 90° Rubber Sheathed Material: Silicon Rubber

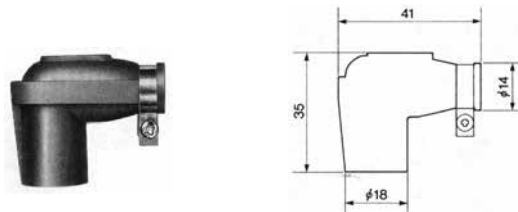

Part No.	Stock No.	Colour	Resistor	Ø Plug	Terminal Type
TRS1225-B	8787	Blue	5 kΩ	14mm	Special*

Description: 90° Compact Type Material: Silicon Rubber

***Suitable for use with R6120-□ racing spark plugs only**
***Suitable for use with R7282-□ racing spark plugs only**

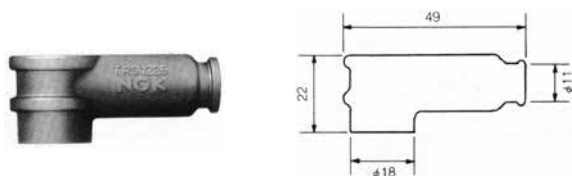

Part No.	Stock No.	Colour	Resistor	Ø Plug	Terminal Type
TRS1408-F-B	8871	Blue	5 kΩ	14mm	Special*

Description: 90° Compact Type Material: Silicon Rubber

***Suitable for use with R5300A-□ racing spark plugs only**

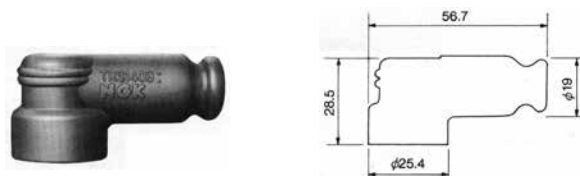

Part No.	Stock No.	Colour	Resistor	Ø Plug	Terminal Type
TRS1409-R	8733	Red	None	14mm	

Description: 90° Compact Type Material: Silicon Rubber

***Suitable for use with R5540F-□ racing spark plugs only**

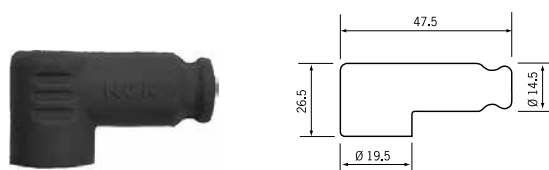

Part No.	Stock No.	Colour	Resistor	Ø Plug	Terminal Type
SD05EG	5818	Black	5 kΩ	10 - 12mm	

Description: Straight Type Material: Phenolic Resin





SPARK PLUG COVERS

Part No.	Stock No.	Colour	Resistor	Ø Plug	Terminal Type
L05EA	6667	Black	5 kΩ	14mm	

Description: 90° Elbow Type Material: Phenolic Resin

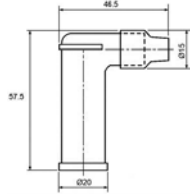
Application: Piaggio (various 125, 150cc)



Part No.	Stock No.	Colour	Resistor	Ø Plug	Terminal Type
V05E	6665	Black	5 kΩ	14mm	

Description: 120° Elbow (Long) Type Material: Phenolic Resin

Application: Piaggio (various 125, 150cc)

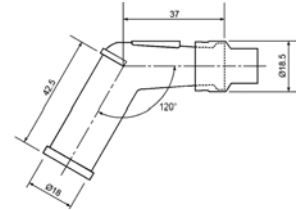

Part No.	Stock No.	Colour	Resistor	Ø Plug	Terminal Type
LB05EPK	8342	Black	5 kΩ	14mm	

Description: 90° Elbow Type Material: Phenolic Resin

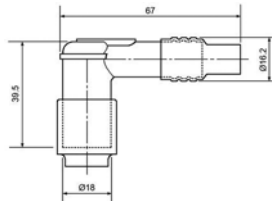

Part No.	Stock No.	Colour	Resistor	Ø Plug	Terminal Type
VD05EM	8422	Black	5 kΩ	10 - 12mm	

Description: 120° Elbow (Long) Type Material: EPDM Rubber

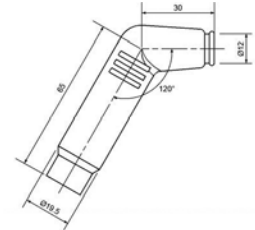

Part No.	Stock No.	Colour	Resistor	Ø Plug	Terminal Type
LB05EZ	8744	Black	5 kΩ	14mm	

Description: 90° Elbow Type Material: Phenolic Resin

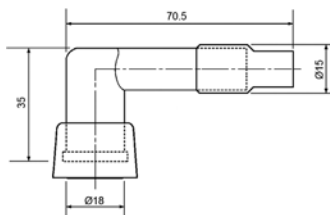

Part No.	Stock No.	Colour	Resistor	Ø Plug	Terminal Type
VD05EMH	7744	Black	5 kΩ	10 - 12mm	
VD05FMH	8425	Black	5 kΩ	10 - 12mm	

Description: 120° Elbow (Compact) Type Material: EPDM Rubber

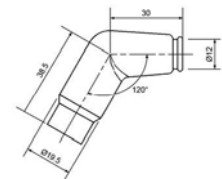

Part No.	Stock No.	Colour	Resistor	Ø Plug	Terminal Type
SD05FP	8325	Black	5 kΩ	10 - 12mm	

Description: Straight Type Material: Phenolic Resin

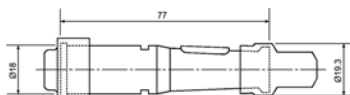

Part No.	Stock No.	Colour	Resistor	Ø Plug	Terminal Type
SD05FGA	8683	Black	5 kΩ	10 - 12mm	

Description: Straight with Grommet Material: Phenolic Resin

Application: Honda VT600, XL600

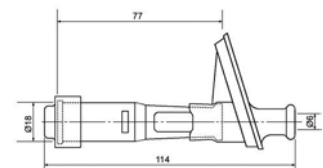

NTK LAMBDA SENSORS FOR MOTORCYCLES

Reducing the pollution created by the internal combustion engine is a great concern for us all. To ensure that manufacturers build cleaner engines, the allowable limits for certain polluting gases are set by various government bodies. These limits are getting ever tighter and engine designers are under great pressure to find ways of meeting the targets. A vital part of the pollution control used on many engines is the exhaust gas oxygen sensor - more commonly known as the Lambda sensor. Commonplace on cars since the 1990's, Lambda sensors have been used on motorcycles since 1999 and are now fitted to an increasing number of machines over 125cc.

WHAT DOES THE LAMBDA SENSOR DO?

The most popular method used by vehicle manufacturers to reduce engine emissions is the three-way catalyst (catalytic converter). This device has the ability to take the three main toxic gases produced by an engine which are carbon monoxide (CO), oxides of nitrogen (NO_x) and hydrocarbons (HC) and convert them to considerably less harmful, non-poisonous gases: carbon dioxide (CO₂), water (H₂O) and nitrogen (N₂).

To carry out this conversion of gases efficiently the catalyst must operate within a specified temperature range but also be provided with exhaust gases that are within certain very tight tolerances dependant predominantly on air/fuel ratio. The precise control required to operate this system is provided by the use of an exhaust gas oxygen (Lambda) sensor installed upstream of the catalyst. A Lambda sensor has the ability to precisely measure the residual oxygen present in exhaust gases. By sending a signal to the control unit it can initiate a change to keep the fuelling system operating within the very tight tolerances required. This is known as a closed-loop control system.

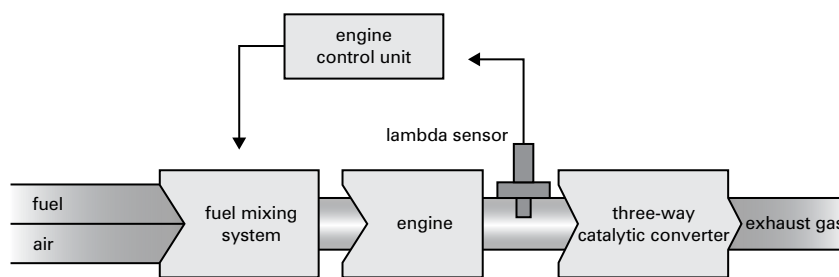

A worn or damaged sensor may affect the bike's general performance, increase fuel consumption, increase unwanted emissions and even damage the catalyst.

TECHNICAL INFORMATION

TORQUE FIGURES

Torque figures and thread form information:
M18 x 1.5 mm - 35 ~ 45Nm **M12 x 1.25 mm - 18 ~ 23Nm**

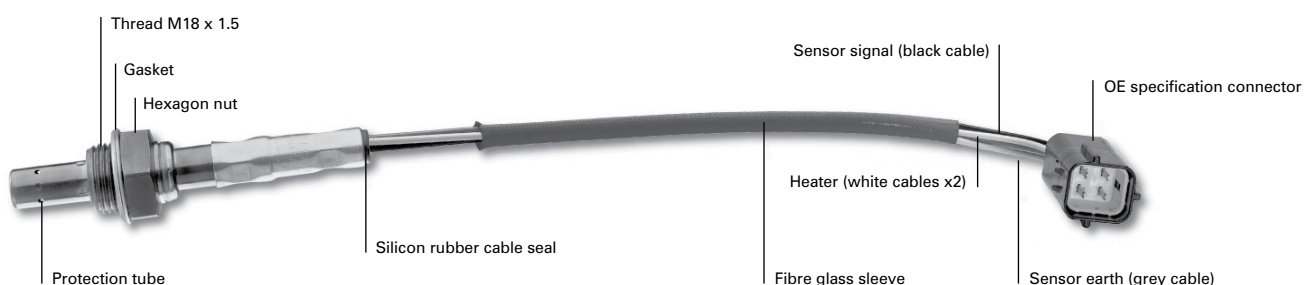

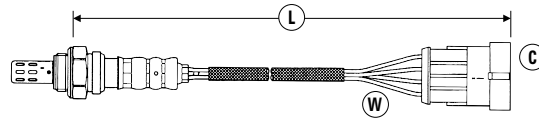

(W) = Number of Wires
 (C) = Connector Type (see page 124)
 (L) = Length of Sensor and lead (mm)

CC/MODEL	ENGINE	OE-NO.	DATE	(W)	(C)	(L)	NTK PART NO.	STOCK NO.
APRILIA								
1000								
RSV 1000 R	Rotax V2	A2 C 53025886	04/04→	4	31	590	OZA591-SZ1	1767
RSV 1000 R Factory	Rotax V2	A2 C 53025886	10/03→	4	31	590	OZA591-SZ1	1767
ETV 1000 Caponord		AP8127295	04→07	4	33	890	OZA222-SG2	0034
BMW								
650								
F650CS		11787 685 320	11/01→12/03	4	68	341	OZA630-BM3	0074
F650CS	K14/02	11787 685 320	01/04→12/05	4	68	341	OZA630-BM3	0074
F650GS/GS Dakar		11787 685 320	09/99→12/03	4	68	341	OZA630-BM3	0074
F650GS/GS Dakar	R13Mü	11787 685 320	12/03→11/07	4	68	341	OZA630-BM3	0074
G650 Xchallenge, Xcountry, Xmoto	K15	11787 674 452	07→09	4	99	231	OZA630-BM1	0072
G650GS	R13	11787 685 320	03/11→	4	68	341	OZA630-BM3	0074
G650GS Sertão	R13	11787 685 320	03/12→	4	68	341	OZA630-BM3	0074
800								
F650GS/GS Dakar		11787 672 785	11/07→	4	99	521	OZA630-BM2	0073
F800GS	K72	11787 672 785	11/07→	4	99	521	OZA630-BM2	0073
F800R	K73	11787 672 785	05/09→	4	99	521	OZA630-BM2	0073
F800S/ST	K71	11787 672 785	12/05→	4	99	521	OZA630-BM2	0073
850								
R850R	R28	11787 671 756	07/02→08/05	4	69	922	OZA522-BM1	0053
R850RT	R22	11787 671 756	03/01→12/04	4	69	922	OZA522-BM1	0053
1085								
R1100S	259S	11787 671 756	01/03→12/03	4	69	922	OZA522-BM1	0053
1150								
R1150GS	R21	11787 671 756	11/01→12/03	4	69	922	OZA522-BM1	0053
R1150GS Adventure	R21	11787 671 756	11/01→09/06	4	69	922	OZA522-BM1	0053
R1150R	R28	11787 671 756	10/02→08/05	4	69	922	OZA522-BM1	0053
R1150RS/RT	R22	11787 671 756	03/01→12/04	4	69	922	OZA522-BM1	0053
1170								
HP2 Enduro	K25 HP	11787 674 452	12/05→11/08	4	99	231	OZA630-BM1	0072
HP2 Megamoto	K25 HP	11787 674 452	07→08	4	99	231	OZA630-BM1	0072
HP2 Sport	K29 HP	11787 672 785	08→	4	99	521	OZA630-BM2	0073
1200								
K1200GT	K41GT	11787 671 756	11/02→08/05	4	69	922	OZA522-BM1	0053
K1200GT	K44	11787 672 785	12/05→	4	99	521	OZA630-BM2	0073
K1200R	K43	11787 672 785	03/05→	4	99	521	OZA630-BM2	0073
K1200R Sport	K43	11787 672 785	11/07→	4	99	521	OZA630-BM2	0073
K1200S	K40	11787 672 785	06/04→	4	99	521	OZA630-BM2	0073
K1200LT	K589	11787 671 757	01/04→	4	69	554	OZA522-BM2	0054
K1200RS	K41	11787 671 756	01/01→12/04	4	69	922	OZA522-BM1	0053
R1200C/CL	259C/K30	11787 671 756	02/02→12/04	4	69	922	OZA522-BM1	0053
R1200GS	K25	11787 674 452	11/03→09	4	99	231	OZA630-BM1	0072
R1200RT	K26	11787 674 452	10/04→09	4	99	231	OZA630-BM1	0072
R1200S	K29	11787 674 452	10/05→07	4	99	231	OZA630-BM1	0072
R1200ST	K28	11787 674 452	12/04→11/07	4	99	231	OZA630-BM1	0072
1300								
K1300GT	K44	11787 672 785	09→	4	99	521	OZA630-BM2	0073
K1300R	K43	11787 672 785	09→	4	99	521	OZA630-BM2	0073
K1300S	K40	11787 672 785	09→	4	99	521	OZA630-BM2	0073

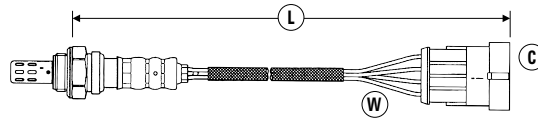

(W) = Number of Wires
 (C) = Connector Type (see page 124)
 (L) = Length of Sensor and lead (mm)

CC/MODEL	ENGINE	OE-NO.	DATE	(W)	(C)	(L)	NTK PART NO.	STOCK NO.
DUCATI								
695								
Monster 695		CA.0083 476	06/04→	4	40	880	OZA591-BB3	0066
992								
GT 1000		CA.0083 476	01/06→	4	40	880	OZA591-BB3	0066
Monster S2R 1000		CA.0083 476	01/06→	4	40	880	OZA591-BB3	0066
Paul Smart 1000		CA.0083 476	01/06→	4	40	880	OZA591-BB3	0066
ST3, ST3S		CA.0083 476	01/04→	4	40	880	OZA591-BB3	0066
Sport 1000		CA.0083 476	01/06→	4	40	880	OZA591-BB3	0066
998								
Monster S4RS		CA.0083 476	06/04→	4	40	880	OZA591-BB3	0066

HONDA								
125								
FES125i Pantheon		36531-KRJ-9010-M1	01/05→	4	96	280	OZA577-H6	0065
PS125i		36531-KTF-6412-M1	01/06→	4	96	210	OZA577-H15	0064
SH125i		36531-KTF-6412-M1	01/05→	4	96	210	OZA577-H15	0064
150								
FES150i Pantheon		36531-KRJ-9010-M1	01/05→	4	96	280	OZA577-H6	0065
1000								
CBF1000		36531-MFA-D010-M1	01/06→	4	80	990	OZA577-H17	0007

HUSQVARNA								
450								
TE450		E 252 201	09/07→	4	97	410	OZA591-WB1	0010
SM450R		E 252 201	09/07→	4	97	410	OZA591-WB1	0010
510								
SM510R		E 252 201	09/07→	4	97	410	OZA591-WB1	0010
610								
SM610		E 252 201	10/06→	4	97	410	OZA591-WB1	0010
650								
TR650 Strada		7674452	10/12→	4	99	231	OZA630-BM1	0072
TR650 Terra		7674452	10/12→	4	99	231	OZA630-BM1	0072

HYOSUNG								
647								
GT650i			01/08→	4	97	410	OZA591-WB1	0010

KTM								
999								
990 Adventure / S		1614 833 0000	01/06→	4	97	500	OZA591-VB2	0009
990 Superduke		1614 833 0000	01/06→	4	97	500	OZA591-VB2	0009

KYMCO								
200								
Yager 200i		3160-0361	06/06→	4	31	590	OZA591-YB1	0011
250								
Venox 250 Afi		3160-0361	06/06→	4	31	590	OZA591-YB1	0011
Xciting 250i		3160-0361	06/06→	4	31	590	OZA591-YB1	0011

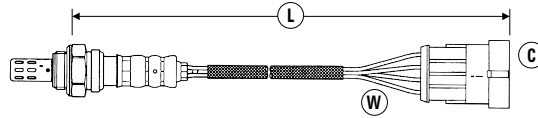

(W) = Number of Wires
 (C) = Connector Type (see page 124)
 (L) = Length of Sensor and lead (mm)

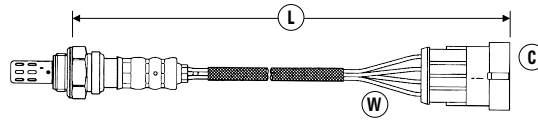

CC/MODEL	ENGINE	OE-NO.	DATE	(W)	(C)	(L)	NTK PART NO.	STOCK NO.
MOTO GUZZI								
750								
Breva V750 i.e.		CA.0083477.A	01/03→	4	40	310	OZA591-BB2	1710
Nevada V750 i.e.		CA.0083477.A	01/06→	4	40	310	OZA591-BB2	1710
877								
Breva V850 i.e.		CA.0083477.A	01/06→	4	40	310	OZA591-BB2	1710
Griso V850 i.e.		CA.0083477.A	01/06→	4	40	310	OZA591-BB2	1710
Norge V850 i.e.		CA.0083477.A	01/06→	4	40	310	OZA591-BB2	1710
1100								
Breva V 1100		CA.0019 265	03/04→12/05	4	40	310	OZA341-BB1	0036
Breva V 1100 i.e.		CA.0083477.A	01/06→	4	40	310	OZA591-BB2	1710
California		CA.0019 265	03/04→12/05	4	40	310	OZA341-BB1	0036
California		CA.0083477.A	01/06→	4	40	310	OZA591-BB2	1710
Griso V 1100 i.e.		CA.0083477.A	01/06→	4	40	310	OZA591-BB2	1710
V11 Models		CA.0019 265	03/04→12/05	4	40	310	OZA341-BB1	0036
1150								
Norge 1200		CA.0083477.A	01/06→12/08	4	40	310	OZA591-BB2	1710
Sport V 1200		CA.0083477.A	01/06→12/08	4	40	310	OZA591-BB2	1710
Stelvio 1200 4V		CA.0083477.A	01/06→12/10	4	40	310	OZA591-BB2	1710
MOTO MORINI								
1187								
9½		CA.0083477.A	01/06→	4	40	310	OZA591-BB2	1710
Corsaro		CA.0083477.A	01/06→	4	40	310	OZA591-BB2	1710
MV AGUSTA								
910								
F4 Brutale 910		CA.0083477.A	10/06→12/08	4	40	310	OZA591-BB2	1710
989								
Brutale 989		CA.0083477.A	01/09→	4	40	310	OZA591-BB2	1710
998								
F4 1000R		CA.0083477.A	10/06→12/08	4	40	310	OZA591-BB2	1710
1078								
Brutale 1078 RR		CA.0083477.A	01/09→	4	40	310	OZA591-BB2	1710
F4 1000		CA.0083477.A	07/07→12/08	4	40	310	OZA591-BB2	1710
F4 1078R		CA.0083477.A	01/09→	4	40	310	OZA591-BB2	1710
SUZUKI								
600								
GSR600		18213-01H00	01/07→12/10	4	80	690	OZA448-J4	0003
GSX-R600		18213-01H00	03/06→12/07	4	80	690	OZA448-J4	0003
750								
GSX-R750		18213-01H00	03/06→12/07	4	80	690	OZA448-J4	0003
1800								
VZR1800 K6 M1800R Intruder		18213-48G00	04/06→	4	80	370	OZA448-J5	0004



(W) = Number of Wires
 (C) = Connector Type (see page 124)
 (L) = Length of Sensor and lead (mm)

CC/MODEL	ENGINE	OE-NO.	DATE	(W)	(C)	(L)	NTK PART NO.	STOCK NO.
TRIUMPH								
600								
Daytona 600		22 01 347	01/03→12/04	4	97	640	OZA591-UB1	0067
650								
Daytona 650		22 01 347	01/04→12/05	4	97	640	OZA591-UB1	0067
600								
Speed Four		22 01 347	01/02→	4	97	640	OZA591-UB1	0067
885								
Thunderbird Sport		22 01 347	01/03→12/04	4	97	640	OZA591-UB1	0067
955								
Daytona 955i		22 01 344 / 05LS002	01/01→12/04	4	33	890	OZA222-SG2	0034
Speed Triple		22 01 344 / 05LS002	01/01→12/05	4	33	890	OZA222-SG2	0034
Sprint RS		22 01 344 / 05LS002	01/01→12/04	4	33	890	OZA222-SG2	0034
Sprint ST		22 01 344 / 05LS002	01/01→12/04	4	33	890	OZA222-SG2	0034
Tiger		22 01 344 / 05LS002	01/03→12/07	4	33	890	OZA222-SG2	0034
1050								
Sprint ST		22 01 347	01/05→	4	97	640	OZA591-UB1	0067
Speed Triple		22 01 347	01/06→12/07	4	97	640	OZA591-UB1	0067
1600								
Thunderbird		22 06 500	07/09→	4	80	250	AZD0101-VB004	7690
2300								
Rocket III		22 01 247	01/04→	4	97	535	OZA591-UB2	0008
Rocket III Classic		22 01 247	01/06→	4	97	535	OZA591-UB2	0008

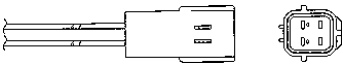
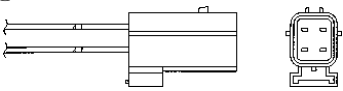
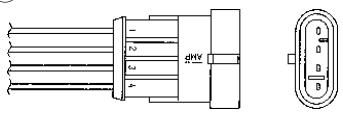
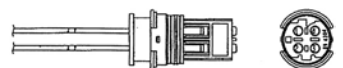
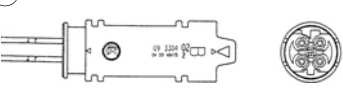
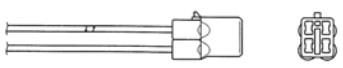
CONNECTOR TYPES

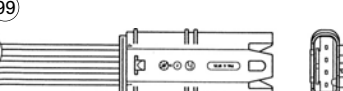
	PART NO.	STOCK NO.
31 	OZA591-YB1	0011
	OZA591-SZ1	1767
33 	OZA222-SG2	0034
40 	OZA341-BB1	0036
68 	OZA447-E28	0427
	OZA630-BM3	0074
69 	OZA522-BM1	0053
	OZA522-BM2	0054
80 	OZA448-J4	0003
	OZA448-J5	0004
	OZA577-H17	0007
	AZD0101-VB004	7690
96 	OZA577-H15	0064
	OZA577-H6	0065
97 	OZA591-UB1	0067
	OZA591-UB2	0008
	OZA591-VB2	0009
99 	OZA630-BM2	0073

WE'VE GOT HIS BACK

Daniil Ivanov
FIM ICE Speedway World Championship



facebook.com/ngksparkplugsuk



NGK UK YouTube



instagram.com/ngkntk_uk



NGK Spark Plugs (UK) Ltd



ngkntk.com



IGNITION
PARTS

THE NO.1 CHOICE THE WORLD OVER

NGK Spark Plugs (UK) Limited
Maylands Avenue
Hemel Hempstead
Hertfordshire
HP2 4SD

Tel: 01442 281000
Fax: 01442 281001



IGNITION
PARTS

www.ngkntk.com